

UNIFORM STANDARDS OF PROFESSIONAL APPRAISAL PRACTICE

2012-2013 EDITION

2012-2013 USPAP

PLUS

Guidance from the Appraisal Standards Board
+ USPAP ADVISORY OPINIONS
+ USPAP FREQUENTLY ASKED QUESTIONS (FAQ)

Effective January 1, 2012
through December 31, 2013

APPRAISAL STANDARDS BOARD



THE APPRAISAL FOUNDATION

*Authorized by Congress as the Source of Appraisal
Standards and Appraiser Qualifications*

UNIFORM STANDARDS OF PROFESSIONAL APPRAISAL PRACTICE

2012-2013 EDITION

APPRAISAL STANDARDS BOARD



THE APPRAISAL FOUNDATION

*Authorized by Congress as the Source of Appraisal
Standards and Appraiser Qualifications*

Published in the United States of America.

ISBN: 978-0-9798728-6-0

All rights reserved.

No parts of this publication may be reproduced, stored in a retrieval system, or transmitted in any form or by any means, electronic, mechanical, photocopy, recording or otherwise, without the prior written consent of the publisher.

EFFECTIVE:

**January 1, 2012 through
December 31, 2013**

2012-2013 PUBLICATIONS

UNIFORM STANDARDS OF PROFESSIONAL APPRAISAL PRACTICE (USPAP)

The Financial Institutions Reform, Recovery and Enforcement Act of 1989 recognizes USPAP as the generally accepted appraisal standards and requires USPAP compliance for appraisers in federally related transactions. State Appraiser Certification and Licensing Boards, federal, state, and local agencies, appraisal services, and appraisal trade associations require compliance with USPAP.

Standards: Provide performance standards for real property, mass, personal property appraisal, consulting and business valuation.

Statements: Clarify, interpret, explain, and elaborate on appraisal standards.

Also, includes the following guidance from the Appraisal Standards Board (ASB):

Advisory Opinions: Offer advice and resolutions for appraisal issues, and problems.

Frequently Asked Questions: A compilation of questions and responses regarding USPAP to be used as a reference for appraisers and users of appraisal services.

2012-2013 USPAP is available in the following options:

- Paperback — Item No. 270 • \$75 • ISBN 978-0-9798728-6-0
- Electronic Interactive — Item No. 271 • \$60*

* See description under Electronic Publications.

Only available at www.appraisalfoundation.org, click on Foundation Store.

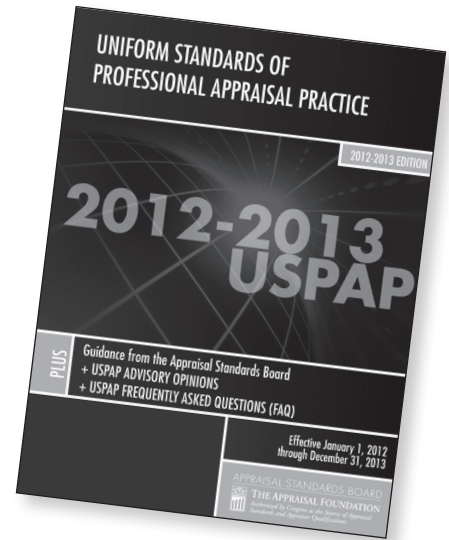

NATIONAL USPAP COURSES

15-HOUR NATIONAL USPAP COURSE STUDENT MANUAL

The National Uniform Standards of Professional Appraisal Practice (USPAP) material is designed to aid appraisers in all areas of appraisal practice seeking competency in the USPAP. This course is intended to fulfill the 15-hour requirement as established by the Appraiser Qualifications Board (AQB) of The Appraisal Foundation.

A copy of the 2012-2013 edition of USPAP should also be purchased to accompany the student manual.

15-Hour National USPAP Course Student Manual Item No. 272 • \$35.00

ISBN: 978-0-9798728-7-7

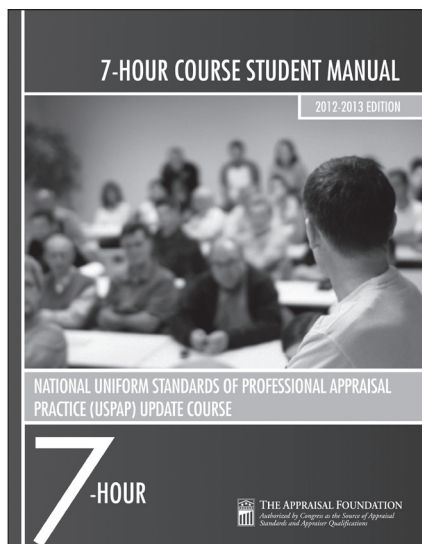
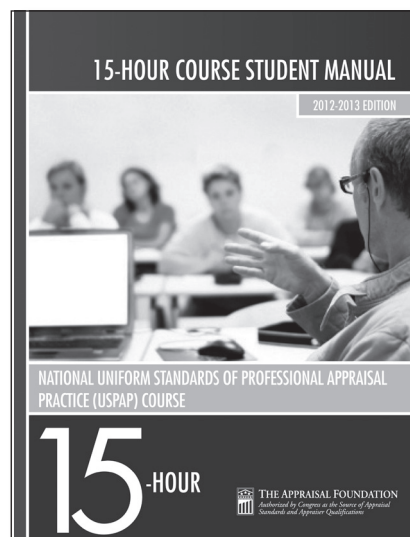

7-HOUR NATIONAL USPAP UPDATE COURSE STUDENT MANUAL

The 7-hour course material focuses on the changes to the 2012-2013 edition of the Uniform Standards of Professional Appraisal Practice (USPAP). This course is intended to fulfill the 7-hour requirement as established by the Appraiser Qualifications Board (AQB) of The Appraisal Foundation.

A copy of the 2012-2013 edition of USPAP should also be purchased to accompany the student manual.

7-Hour National USPAP Update Course Student Manual

Item No. 274 • \$25.00

ISBN: 978-0-9798728-8-4

2012-2013 ELECTRONIC PUBLICATIONS



The downloadable items listed below can only be ordered from the Foundation Store at www.appraisalfoundation.org



E-UNIFORM STANDARDS OF PROFESSIONAL APPRAISAL PRACTICE (USPAP)

Now you can purchase the 2012-2013 USPAP Electronically! Right at your fingertips, you will have a searchable, indexed, user-friendly reference to the Standards, Statements, Advisory Opinions and Frequently Asked Questions.

E-USPAP Interactive • Item No. 271 • \$60.00

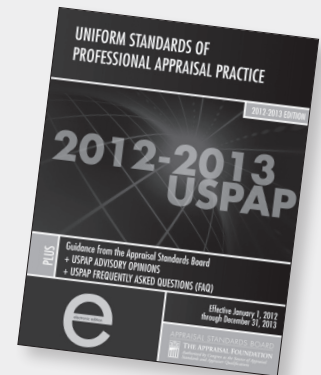

E-15-HOUR NATIONAL USPAP COURSE

The 15-Hour Student Manual is now available as a downloadable PDF file. See book description under National USPAP Course section.

E-15-Hour Interactive • Item No. 273 • \$30.00

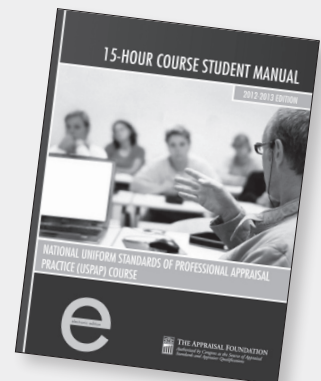

E-7-HOUR NATIONAL USPAP UPDATE COURSE STUDENT MANUAL

The 7-Hour Student Manual is now available as a downloadable PDF file. See book description under National USPAP Course section.

E-7-Hour Interactive • Item No. 275 • \$20.00

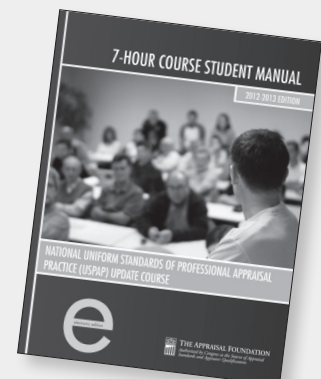

SUBSCRIPTION SERVICE

Receive updates about appraisal issues from the Appraisal Practices Board (APB), Appraisal Standards Board (ASB) and the Appraiser Qualifications Board (AQB) via your email account. This service includes the electronic interactive copy of the current edition of USPAP. See full description under Subscription Service

E-Subscription Service • Item No. 148 • \$99.00

Order online at www.appraisalfoundation.org or call 800-348-2831

SUBSCRIPTION SERVICE

Your Complete Appraisal Source. Keep informed of the current standards and qualifications. This service provides all the vital information you need to stay on top of your profession. You'll be the first to hear about important issues impacting your business. You'll receive updates about crucial appraisal issues from the Appraisal Practices Board (APB), the Appraiser Qualifications Board (AQB) and the Appraisal Standards Board (ASB) on a regular basis. And, with the subscription service, you have the opportunity to make comments on important issues.

YOUR BENEFITS

- Uniform Standards of Professional Appraisal Practice (USPAP) and guidance material
- USPAP monthly Question and Answer Bulletins
- APB, AQB and ASB Meeting Notices and Summaries
- APB, AQB and ASB Exposure Drafts of Action Proposal (for your review and comment)
- Revisions to *Real Property Appraiser Qualifications Criteria* (including new Interpretations and Guide Notes)
- Press Releases

You have the option of receiving this service through the mail or via an email address.

SUBSCRIPTION SERVICE – PAPER

(Includes paper copy of USPAP)

1 Year \$150 (Item No. 071)

SUBSCRIPTION SERVICE – ELECTRONIC*

(Includes electronic copy of USPAP)

1 Year \$ 99 (Item No. 148)

**Available from our web store only.*

SHIPPING AND HANDLING

STANDARD DELIVERY

All orders are shipped standard ground delivery. Processing and shipping time averages between 7-10 business days. Our standard carrier requires a street address. Please place your order allowing adequate time for delivery. Rush services are available.

Up to \$100	\$10.50
\$100.01 to \$200	\$15.00
\$200.01 to \$500	\$35.00
\$500.01 to \$1,000	\$60.00
\$1,000.01 to \$2,500	\$100.00
\$2,500.01 to \$5,000	\$150.00
\$5,000.01 to \$7,500	\$175.00
\$7,500.01 to \$10,000	\$200.00

For larger quantities, call for shipping rates

For deliveries outside the contiguous U.S., call for shipping rates. Additional charges apply.

RUSH DELIVERY

Rush services are available for an additional fee of \$10.00. Actual shipping costs also apply. Orders placed by 1:00 p.m. (Eastern) can be shipped the same day for overnight, 2nd day, 3rd day air delivery and for regular ground rushes. Be sure to request rush delivery services.

RETURNS AND REFUNDS

Returns accepted within 60 days only. Merchandise must be returned in good condition for a refund. Authorization for the return is required. Call 800-348-2831.

Shipping Charges Are Non-Refundable Once Your Order Has Shipped.

Returns should be shipped to
(authorization required)

The Appraisal Foundation
c/o BrightKey
9050 Junction Drive, Suite B
Annapolis Junction, Maryland 20701

FOUR WAYS TO ORDER



1. Phone toll free 800.348.2831 or call 240.646.7010



2. Fax your order form with credit card information to 240.396.5695



3. Mail your order form and payment to:
The Appraisal Foundation
Distribution Center
P.O. Box 381
Annapolis Junction, Maryland 20701-0381



4. Online at the Foundation Store at www.appraisalfoundation.org.

Order online at www.appraisalfoundation.org or call 800-348-2831

THE APPRAISAL FOUNDATION 2012-2013 PUBLICATIONS AND SERVICES

2012-2013 PUBLICATIONS

ITEM No.	PRODUCT	COST PER MANUAL	QUANTITY	TOTAL
270	Uniform Standards of Professional Appraisal Practice (USPAP) ISBN: 978-0-9798728-6-0			
	1-50 copies	\$75.00		
	51-250 copies	\$60.00		
	251 copies or more	\$50.00		
272	15-Hour National USPAP Course Student Manual ISBN: 978-0-9798728-7-7			
	1-100 copies	\$35.00		
	101-250 copies	\$28.00		
	251 copies or more	\$23.00		
274	7-Hour National USPAP Update Course Student Manual ISBN: 978-0-9798728-8-4			
	1-100 copies	\$25.00		
	101-250 copies	\$20.00		
	251 copies or more	\$17.00		

2012-2013 SERVICES

ITEM No.	PRODUCT	COST PER MANUAL	QUANTITY	TOTAL
071	1 Year Subscription Service (Paper)	\$150.00		

Publications and Services Subtotal: \$ _____

For more information on our electronic publications and services, please visit our web site at www.appraisalfoundation.org, click on Foundation Store.

Order online at www.appraisalfoundation.org or call 800-348-2831

2012-2013 ORDER FORM

ORDER INFORMATION

Subtotal from Publications and Services List (Subtotal from page 1) \$ _____

Shipping and Handling Charges (See Shipping and Handling for details and costs) \$ _____

Rush Fee (additional \$10.00) \$ _____

Maryland Residents add 6% sales tax \$ _____

Order Total: \$ _____

PAYMENT INFORMATION (Prepayment Required)

Check/Money Order enclosed (Make checks payable to The Appraisal Foundation)

Credit Card: American Express Discover MasterCard VISA

Card No. _____

Expiration Date: _____

Signature _____

SHIP TO INFORMATION

Name: _____

Organization: _____

Shipping Address: _____

City: _____

State: _____

Zip: _____

Telephone Number: _____

Email Address: _____

(Required for electronic services)

USPAP12

Prices effective 09/1/11. Subject to change without notice.

FOUR WAYS TO ORDER



1. Phone toll free 800.348.2831 or call 240.646.7010



2. Fax your order form with credit card information to 240.396.5695



3. Mail your order form and payment to:
The Appraisal Foundation
Distribution Center
P.O. Box 381
Annapolis Junction, Maryland 20701-0381



4. Online at the Foundation Store at www.appraisalfoundation.org.



THE APPRAISAL FOUNDATION

Authorized by Congress as the Source of Appraisal Standards and Appraiser Qualifications

Order online at www.appraisalfoundation.org or call 800-348-2831

APPRAISAL STANDARDS BOARD



THE APPRAISAL FOUNDATION

*Authorized by Congress as the Source of Appraisal
Standards and Appraiser Qualifications*

FOREWORD

The Appraisal Standards Board (ASB) of The Appraisal Foundation develops, interprets, and amends the *Uniform Standards of Professional Appraisal Practice* (USPAP) on behalf of appraisers and users of appraisal services. **The 2012-2013 Edition of USPAP (2012-2013 USPAP) is effective January 1, 2012 through December 31, 2013.**

USPAP has five sections: DEFINITIONS, PREAMBLE, Rules, Standards and Standards Rules, and Statements on Appraisal Standards. For convenience of reference, USPAP is published with this Foreword and a Table of Contents. The publication also includes the Advisory Opinions and Frequently Asked Questions (FAQs) as additional reference materials. These reference materials are forms of “Other Communications” provided by the ASB for guidance only and are not part of USPAP.

It is important that individuals understand and adhere to changes that are adopted in each edition of USPAP. State and federal regulatory authorities enforce the content of the current or applicable edition of USPAP.

History of USPAP

These Standards are based on the original *Uniform Standards of Professional Appraisal Practice* developed in 1986–87 by the Ad Hoc Committee on Uniform Standards and copyrighted in 1987 by The Appraisal Foundation. The effective date of the original Uniform Standards was April 27, 1987. Prior to the establishment of the ASB in 1989, USPAP had been adopted by major appraisal organizations in North America. USPAP represents the generally accepted and recognized standards of appraisal practice in the United States.

At its organizational meeting on January 30, 1989, the Appraisal Standards Board unanimously approved and adopted the original USPAP as the initial appraisal standards promulgated by the ASB. Portions of USPAP may be amended, interpreted, supplemented, or retired by the ASB after exposure to the appraisal profession, users of appraisal services, and the public in accordance with established rules of procedure.

Changes to USPAP

Over the years, USPAP has evolved in response to changes in appraisal practice. The ASB has developed a process for developing both Standards and guidance based, in part, on written comments submitted in response to exposure drafts and oral testimony presented at public meetings.

Guidance

The ASB issues guidance in the form of Advisory Opinions, *USPAP Frequently Asked Questions* (FAQ) and periodic questions and responses “USPAP Q&A.” These communications do not establish new Standards or interpret existing Standards and are not part of USPAP. They illustrate the applicability of Standards in specific situations and offer advice from the ASB for the resolution of specific appraisal issues and problems.

The USPAP Q&A is published periodically and available on The Appraisal Foundation website. These questions and responses are compiled and published in the *USPAP Frequently Asked Questions*.

FOREWORD

Contacting the Appraisal Standards Board

The ASB invites questions about USPAP, commentary on USPAP and proposed changes to USPAP from all interested parties, including appraisers, state enforcement agencies, users of appraisal services, and the public.

If you have any comments, questions, or suggestions regarding USPAP, please contact the ASB.

Appraisal Standards Board
The Appraisal Foundation
1155 15th Street, NW, Suite 1111
Washington, DC 20005
Phone: 202-347-7722
Fax: 202-347-7727
E-Mail: info@appraisalfoundation.org
www.appraisalfoundation.org

APPRAISAL STANDARDS BOARD



THE APPRAISAL FOUNDATION

*Authorized by Congress as the Source of Appraisal
Standards and Appraiser Qualifications*

2011 APPRAISAL STANDARDS BOARD MEMBERS

J. Carl Schultz, Jr. – Chair

Barry J. Shea – Vice Chair

Dennis L. Badger

Dennis J. Black

Margaret A. Hambleton

Richard Knitter

R. Lee Robinette

(The 2012-2013 USPAP was adopted by the 2011 Appraisal Standards Board on April 8, 2011.)

2010 APPRAISAL STANDARDS BOARD MEMBERS

Sandra Guilfoil – Chair

J. Carl Schultz, Jr. – Vice Chair

Richard L. Borges II

Richard Knitter

Barry J. Shea

Jay E. Fishman (*January 1, 2010 – June 30, 2010*) *Appointed to the Appraisal Practices Board*

effective July 1, 2010

FOREWORD

Past Appraisal Standards Board Officers and Members

<p><u>1989 Board Members</u> Charles B. Akerson - Chair John J. Leary - Vice Chair Sherwood Darington Daniel A. Dinote, Jr. John L. Gadd</p>	<p><u>1996 Board Members</u> W. David Snook - Chair Laurie Van Court - Vice Chair Stephanie Coleman Tim Leberman</p>	<p><u>2002 Board Members</u> Danny K. Wiley - Chair Lawrence E. Ofner - Vice Chair Carla G. Glass Thomas O. Jackson Kenneth J. Kaiser Richard A. Southern</p>
<p><u>1990 Board Members</u> John J. Leary - Chair Sherwood Darington - Vice Chair Daniel A. Dinote, Jr. John L. Gadd Charles B. Akerson</p>	<p><u>1997 Board Members</u> W. David Snook - Chair Laurie Van Court - Vice Chair Stephanie Coleman Kenneth J. Kaiser Tim Leberman</p>	<p><u>2003 Board Members</u> Danny K. Wiley - Chair Lawrence E. Ofner - Vice Chair Gregory J. Accetta Carla G. Glass Paula K. Konikoff Dawn M. Molitor-Gennrich</p>
<p><u>1991 Board Members</u> John J. Leary - Chair Sherwood Darington - Vice Chair Daniel A. Dinote, Jr. John L. Gadd Charles B. Akerson</p>	<p><u>1998 Board Members</u> Tim Leberman - Chair Kenneth J. Kaiser - Vice Chair Stephanie Coleman Yale Kramer W. David Snook Laurie Van Court</p>	<p><u>2004 Board Members</u> Danny K. Wiley - Chair Carla G. Glass - Vice Chair Gregory J. Accetta Paula K. Konikoff Dawn M. Molitor -Gennrich Lawrence E. Ofner</p>
<p><u>1992 Board Members</u> John J. Leary - Chair Sherwood Darington - Vice Chair Daniel A. Dinote, Jr. John L. Gadd Ritch LeGrand</p>	<p><u>1999 Board Members</u> Kenneth J. Kaiser - Chair Tim Leberman - Vice Chair Yale Kramer Lawrence E. Ofner W. David Snook Laurie Van Court</p>	<p><u>2005 Board Members</u> Carla G. Glass - Chair Gregory J. Accetta - Vice Chair James D. Cannon Paula K. Konikoff Dawn M. Molitor-Gennrich Danny K. Wiley</p>
<p><u>1993 Board Members</u> Ritch LeGrand - Chair Sherwood Darington - Vice Chair Daniel A. Dinote, Jr. John L. Gadd John J. Leary</p>	<p><u>2000 Board Members</u> Kenneth J. Kaiser - Chair Yale Kramer Lawrence E. Ofner W. David Snook Richard A. Southern Laurie Van Court *No Vice Chair</p>	<p><u>2006 Board Members</u> Gregory J. Accetta - Chair Paula K. Konikoff - Vice Chair James D. Cannon Carla G. Glass Dawn M. Molitor-Gennrich William J. Pastuszek, Jr. Danny K. Wiley</p>
<p><u>1994 Board Members</u> Sherwood Darington - Chair Daniel A. Dinote, Jr. - Vice Chair Tim Leberman John J. Leary Ritch LeGrand</p>	<p><u>2001 Board Members</u> Kenneth J. Kaiser - Chair Richard A. Southern - Vice Chair Thomas O. Jackson Carla G. Glass Lawrence E. Ofner Danny K. Wiley</p>	<p><u>2007 Board Members</u> Gregory J. Accetta - Chair Noreen Dornenburg - Vice Chair Paula K. Konikoff Dawn M. Molitor-Gennrich William J. Pastuszek, Jr. William Henry Riley</p>
<p><u>1995 Board Members</u> Sherwood Darington - Chair Tim Leberman - Vice Chair Daniel A. Dinote, Jr. W. David Snook Laurie Van Court</p>		

Past Appraisal Standards Board Officers and Members - Continued

<p><u>2008 Board Members</u> Sandra Guilfoil - Chair Paula K. Konikoff - Vice Chair Gregory J. Accetta Richard L. Borges II Richard Knitter William Henry Riley III</p> <p><u>2009 Board Members</u> Sandra Guilfoil - Chair J. Carl Schultz, Jr. - Vice Chair Richard L. Borges II Jay E. Fishman Richard Knitter Barry J. Shea</p>		
--	--	--

REVISIONS TO USPAP AND USPAP ADVISORY OPINIONS

After the publication of the 2010-11 edition of USPAP, a series of five exposure drafts were released to obtain feedback on possible modifications for the 2012-13 edition. On April 8, 2011, the Appraisal Standards Board (ASB) approved and adopted modifications to the 2012-13 edition of the *Uniform Standards of Professional Appraisal Practice* (USPAP). These modifications include:

- 1. Revisions to DEFINITIONS of “Client,” “Extraordinary Assumption,” and “Hypothetical Condition,” as well as moving the definition of “Exposure Time” from STATEMENT ON APPRAISAL STANDARDS NO. 6 (SMT-6) to the DEFINITIONS section** - The definition of client was revised to further clarify the proper application of the term client and to facilitate in the proper identification of the Client in assignments. Adding the concept of the effective date of the assignment results to the definitions of Extraordinary Assumption and Hypothetical Condition will reduce misunderstanding and misapplication of both terms. The definition of Exposure Time has been moved from SMT-6 to the DEFINITIONS section which will enhance the usability of USPAP.
- 2. Creation of a new RECORD KEEPING RULE and Related Edits to the Conduct Section of the ETHICS RULE** - The Board heard concerns about the location of record keeping requirements within the ETHICS RULE. After exposing the concept of moving record keeping into a separate rule, it was determined that record keeping should be a separate Rule. However, a provision was added to the ETHICS RULE so that anyone who willfully or knowingly violates the RECORD KEEPING RULE is also in violation of the ETHICS RULE.
- 3. Revisions Relating to Development and Disclosure of Exposure Time Opinion** - In order to assure that intended users understand the context in which the opinion of value is developed, the Board has adopted revisions to make it a clear requirement that reasonable exposure time must be *reported* in all assignments in which an opinion of reasonable exposure time must be *developed*. As clarified in the 2012-13 edition of USPAP, exposure time must be developed “When exposure time is a component of the definition for the value opinion being developed.”
- 4. Revisions to Standards Rules 2-3, 3-6, 5-3, 6-9, 8-3 and 10-3 (signed certification statement)** - The 2010-11 edition of USPAP initiated the requirement to disclose any services regarding the subject property performed by the appraiser within the prior three years in the report certification. Another requirement of USPAP is the appraiser must disclose in the certification either the presence or absence of any *current or prospective interest* regarding the subject or the parties involved. To improve consistency, for the 2012-13 edition of USPAP the Board is requiring that prior service(s) regarding the subject property be treated similarly in the certification as current/prospective interests are treated.
- 5. Revisions to STANDARDS 7 and 8: PERSONAL PROPERTY APPRAISAL, DEVELOPMENT and REPORTING** - The changes to STANDARDS 7 and 8 were, in large part, the result of the work of an appointed task force made up of personal property appraisers. It had been several years since a comprehensive review had been made of STANDARDS 7 and 8, and after a thorough review, the task force made numerous recommendations to the Board, most of which were adopted by the Board.
- 6. Revisions to Advisory Opinion 21, USPAP Compliance** - **The revisions to Advisory Opinion 21 were made in response to questions and concerns from appraisers, appraisal clients and state appraisal regulatory officials. Advisory Opinion 21 (AO-21) contains a series of questions with responses along with illustrative examples. The illustrations in AO-21 were reviewed and updated or replaced as necessary to provide relevant guidance regarding when USPAP applies.**

Administrative edits were also made to USPAP and all guidance material, including the *USPAP Advisory Opinions* and *USPAP Frequently Asked Questions*, for conformity and consistency. The details of the changes to the 2012-13 edition of USPAP can be read on the Appraisal Foundation's website, www.appraisalfoundation.org in a document entitled *2011 Summary of Actions Related to Proposed USPAP Changes*.

TABLE OF CONTENTS

UNIFORM STANDARDS OF PROFESSIONAL APPRAISAL PRACTICE

DEFINITIONSU-1
PREAMBLE.....U-6
ETHICS RULE.....U-7
RECORD KEEPING RULEU-10
COMPETENCY RULE.....U-11
SCOPE OF WORK RULE.....U-13
JURISDICTIONAL EXCEPTION RULEU-15

Standards and Standards Rules

STANDARD 1: REAL PROPERTY APPRAISAL, DEVELOPMENT.....U-16
STANDARD 2: REAL PROPERTY APPRAISAL, REPORTING.....U-22
STANDARD 3: APPRAISAL REVIEW, DEVELOPMENT AND REPORTINGU-31
STANDARD 4: REAL PROPERTY APPRAISAL CONSULTING, DEVELOPMENTU-39
STANDARD 5: REAL PROPERTY APPRAISAL CONSULTING, REPORTINGU-42
STANDARD 6: MASS APPRAISAL, DEVELOPMENT AND REPORTING.....U-46
STANDARD 7: PERSONAL PROPERTY APPRAISAL, DEVELOPMENTU-57
STANDARD 8: PERSONAL PROPERTY APPRAISAL, REPORTINGU-62
STANDARD 9: BUSINESS APPRAISAL, DEVELOPMENTU-71
STANDARD 10: BUSINESS APPRAISAL, REPORTING.....U-75

Statements on Appraisal Standards

Statements on Appraisal Standards (SMT) are authorized by the by-laws of The Appraisal Foundation and are specifically for the purposes of clarification, interpretation, explanation, or elaboration of the *Uniform Standards of Professional Appraisal Practice* (USPAP). Statements have the full weight of a Standards Rule and can be adopted by the Appraisal Standards Board only after exposure and comment.

Each Statement is labeled as to its applicability to the various appraisal disciplines. The abbreviations are:

- Real Property – RP
- Personal Property – PP
- Intangible Property – IP (includes business interests)
- All disciplines – ALL

STATEMENT ON APPRAISAL STANDARDS NO. 1 (SMT-1)U-81
STATEMENT ON APPRAISAL STANDARDS NO. 2 (SMT-2)U-82
STATEMENT ON APPRAISAL STANDARDS NO. 3 (SMT-3)U-85
STATEMENT ON APPRAISAL STANDARDS NO. 4 (SMT-4)U-87
STATEMENT ON APPRAISAL STANDARDS NO. 5 (SMT-5)U-89
STATEMENT ON APPRAISAL STANDARDS NO. 6 (SMT-6)U-90
STATEMENT ON APPRAISAL STANDARDS NO. 7 (SMT-7)U-92
STATEMENT ON APPRAISAL STANDARDS NO. 8 (SMT-8)U-93
STATEMENT ON APPRAISAL STANDARDS NO. 9 (SMT-9)U-94
STATEMENT ON APPRAISAL STANDARDS NO. 10 (SMT-10)U-98

UNIFORM STANDARDS OF PROFESSIONAL APPRAISAL PRACTICE

as promulgated by the
Appraisal Standards Board of
The Appraisal Foundation

DEFINITIONS

For the purpose of the *Uniform Standards of Professional Appraisal Practice* (USPAP), the following definitions apply:

APPRAISAL: (noun) the act or process of developing an opinion of value; an opinion of value.
(adjective) of or pertaining to appraising and related functions such as appraisal practice or appraisal services.

Comment: An appraisal must be numerically expressed as a specific amount, as a range of numbers, or as a relationship (e.g., not more than, not less than) to a previous value opinion or numerical benchmark (e.g., assessed value, collateral value).

APPRAISAL CONSULTING: the act or process of developing an analysis, recommendation, or opinion to solve a problem, where an opinion of value is a component of the analysis leading to the assignment results.

Comment: An appraisal consulting assignment involves an opinion of value but does not have an appraisal or an appraisal review as its primary purpose.

APPRAISAL PRACTICE: valuation services performed by an individual acting as an appraiser, including but not limited to appraisal, appraisal review, or appraisal consulting.

Comment: *Appraisal practice* is provided only by appraisers, while *valuation services* are provided by a variety of professionals and others. The terms *appraisal*, *appraisal review*, and *appraisal consulting* are intentionally generic and are not mutually exclusive. For example, an opinion of value may be required as part of an appraisal review and is required as a component of the analysis in an appraisal consulting assignment. The use of other nomenclature for an appraisal, appraisal review, or appraisal consulting assignment (e.g., analysis, counseling, evaluation, study, submission, or valuation) does not exempt an appraiser from adherence to the *Uniform Standards of Professional Appraisal Practice*.

APPRAISAL REVIEW: the act or process of developing and communicating an opinion about the quality of another appraiser's work that was performed as part of an appraisal, appraisal review, or appraisal consulting assignment.

Comment: The subject of an appraisal review assignment may be all or part of a report, workfile, or a combination of these.

APPRAISER: one who is expected to perform valuation services competently and in a manner that is independent, impartial, and objective.

Comment: Such expectation occurs when individuals, either by choice or by requirement placed upon them or upon the service they provide by law, regulation, or agreement with the client or intended users, represent that they comply.¹

¹ See PREAMBLE and Advisory Opinion 21, *USPAP Compliance*.

DEFINITIONS

38 **APPRAISER'S PEERS:** other appraisers who have expertise and competency in a similar type of assignment.

39 **ASSIGNMENT:** 1) An agreement between an appraiser and a client to provide a valuation service; 2) the
40 valuation service that is provided as a consequence of such an agreement.

41 **ASSIGNMENT RESULTS:** an appraiser's opinions and conclusions developed specific to an assignment.

42 Comment: Assignment results include an appraiser's:

- 43 ▪ opinions or conclusions developed in an appraisal assignment, such as value;
- 44 ▪ opinions of adequacy, relevancy, or reasonableness developed in an appraisal review assignment;
- 45 or
- 46 ▪ opinions, conclusions, or recommendations developed in an appraisal consulting assignment.

47 **ASSUMPTION:** that which is taken to be true.

48 **BIAS:** a preference or inclination that precludes an appraiser's impartiality, independence, or objectivity in an
49 assignment.

50 **BUSINESS ENTERPRISE:** an entity pursuing an economic activity.

51 **BUSINESS EQUITY:** the interests, benefits, and rights inherent in the ownership of a business enterprise or a
52 part thereof in any form (including, but not necessarily limited to, capital stock, partnership interests,
53 cooperatives, sole proprietorships, options, and warrants).

54 **CLIENT:** the party or parties who engage, by employment or contract, an appraiser in a specific assignment.

55 Comment: The client may be an individual, group, or entity, and may engage and communicate with
56 the appraiser directly or through an agent.

57 **CONFIDENTIAL INFORMATION:** information that is either:

- 58 ▪ identified by the client as confidential when providing it to an appraiser and that is not available
- 59 from any other source; or
- 60 ▪ classified as confidential or private by applicable law or regulation*.

61 *NOTICE: For example, pursuant to the passage of the Gramm-Leach-Bliley Act in November 1999, some
62 public agencies have adopted privacy regulations that affect appraisers. As a result, the Federal Trade
63 Commission issued a rule focused on the protection of "non-public personal information" provided by
64 consumers to those involved in financial activities "found to be closely related to banking or usual in connection
65 with the transaction of banking." These activities have been deemed to include "appraising real or personal
66 property." (Quotations are from the Federal Trade Commission, Privacy of Consumer Financial Information;
67 Final Rule, 16 CFR Part 313.)

68 **COST:** the amount required to create, produce, or obtain a property.

69 Comment: *Cost* is either a fact or an estimate of fact.

70 **CREDIBLE:** worthy of belief.

71 Comment: Credible assignment results require support, by relevant evidence and logic, to the
72 degree necessary for the intended use.

73 **EXPOSURE TIME:** estimated length of time that the property interest being appraised would have been
74 offered on the market prior to the hypothetical consummation of a sale at market value on the effective date of
75 the appraisal.

76 Comment: Exposure time is a retrospective opinion based on an analysis of past events assuming a
77 competitive and open market.

78 **EXTRAORDINARY ASSUMPTION:** an assumption, directly related to a specific assignment, as of the
79 effective date of the assignment results, which, if found to be false, could alter the appraiser's opinions or
80 conclusions.

81 Comment: Extraordinary assumptions presume as fact otherwise uncertain information about
82 physical, legal, or economic characteristics of the subject property; or about conditions
83 external to the property, such as market conditions or trends; or about the integrity of data
84 used in an analysis.

85 **FEASIBILITY ANALYSIS:** a study of the cost-benefit relationship of an economic endeavor.

86 **HYPOTHETICAL CONDITION:** a condition, directly related to a specific assignment, which is contrary to
87 what is known by the appraiser to exist on the effective date of the assignment results, but is used for the
88 purpose of analysis.

89 Comment: Hypothetical conditions are contrary to known facts about physical, legal, or
90 economic characteristics of the subject property; or about conditions external to the property,
91 such as market conditions or trends; or about the integrity of data used in an analysis.

92 **INTANGIBLE PROPERTY (INTANGIBLE ASSETS):** nonphysical assets, including but not limited to
93 franchises, trademarks, patents, copyrights, goodwill, equities, securities, and contracts as distinguished from
94 physical assets such as facilities and equipment.

95 **INTENDED USE:** the use or uses of an appraiser's reported appraisal, appraisal review, or appraisal consulting
96 assignment opinions and conclusions, as identified by the appraiser based on communication with the client at
97 the time of the assignment.

98 **INTENDED USER:** the client and any other party as identified, by name or type, as users of the appraisal,
99 appraisal review, or appraisal consulting report by the appraiser on the basis of communication with the client at
100 the time of the assignment.

101 **JURISDICTIONAL EXCEPTION:** an assignment condition established by applicable law or regulation,
102 which precludes an appraiser from complying with a part of USPAP.

103 **MARKET VALUE:** a type of value, stated as an opinion, that presumes the transfer of a property (i.e., a right
104 of ownership or a bundle of such rights), as of a certain date, under specific conditions set forth in the definition
105 of the term identified by the appraiser as applicable in an appraisal.

DEFINITIONS

106 Comment: Forming an opinion of market value is the purpose of many real property appraisal
107 assignments, particularly when the client's intended use includes more than one intended user.
108 The conditions included in market value definitions establish market perspectives for
109 development of the opinion. These conditions may vary from definition to definition but
110 generally fall into three categories:

- 111 1. the relationship, knowledge, and motivation of the parties (i.e., seller and buyer);
- 112 2. the terms of sale (e.g., cash, cash equivalent, or other terms); and
- 113 3. the conditions of sale (e.g., exposure in a competitive market for a reasonable time
114 prior to sale).

115 ***Appraisers are cautioned to identify the exact definition of market value, and its authority,***
116 ***applicable in each appraisal completed for the purpose of market value.***

117 **MASS APPRAISAL:** the process of valuing a universe of properties as of a given date using standard
118 methodology, employing common data, and allowing for statistical testing.

119 **MASS APPRAISAL MODEL:** a mathematical expression of how supply and demand factors interact in a
120 market.

121 **PERSONAL PROPERTY:** identifiable tangible objects that are considered by the general public as being
122 "personal" - for example, furnishings, artwork, antiques, gems and jewelry, collectibles, machinery and
123 equipment; all tangible property that is not classified as real estate.

124 **PRICE:** the amount asked, offered, or paid for a property.

125 Comment: Once stated, *price* is a fact, whether it is publicly disclosed or retained in private.
126 Because of the financial capabilities, motivations, or special interests of a given buyer or
127 seller, the price paid for a property may or may not have any relation to the *value* that might
128 be ascribed to that property by others.

129 **REAL ESTATE:** an identified parcel or tract of land, including improvements, if any.

130 **REAL PROPERTY:** the interests, benefits, and rights inherent in the ownership of real estate.

131 Comment: In some jurisdictions, the terms *real estate* and *real property* have the same legal
132 meaning. The separate definitions recognize the traditional distinction between the two
133 concepts in appraisal theory.

134 **REPORT:** any communication, written or oral, of an appraisal, appraisal review, or appraisal consulting
135 service that is transmitted to the client upon completion of an assignment

136 Comment: Most reports are written and most clients mandate written reports. Oral report
137 requirements (see the RECORD KEEPING RULE) are included to cover court testimony and
138 other oral communications of an appraisal, appraisal review, or appraisal consulting service.

139 **SCOPE OF WORK:** the type and extent of research and analyses in an assignment.

140 **SIGNATURE:** personalized evidence indicating authentication of the work performed by the appraiser and the
141 acceptance of the responsibility for content, analyses, and the conclusions in the report.

142 **VALUATION SERVICES:** services pertaining to aspects of property value.

143 Comment: Valuation services pertain to all aspects of property value and include services
144 performed both by appraisers and by others.

145 **VALUE:** the monetary relationship between properties and those who buy, sell, or use those properties.

146 Comment: *Value* expresses an economic concept. As such, it is never a fact but always an
147 opinion of the worth of a property at a given time in accordance with a specific definition of
148 value. In appraisal practice, value must always be qualified - for example, market value,
149 liquidation value, or investment value.

150 **WORKFILE:** documentation necessary to support an appraiser's analyses, opinions, and conclusions.

PREAMBLE

151 PREAMBLE

152 The purpose of the *Uniform Standards of Professional Appraisal Practice* (USPAP) is to promote and maintain
153 a high level of public trust in appraisal practice by establishing requirements for appraisers. It is essential that
154 appraisers develop and communicate their analyses, opinions, and conclusions to intended users of their
155 services in a manner that is meaningful and not misleading.

156 The Appraisal Standards Board promulgates USPAP for both appraisers and users of appraisal services. The
157 appraiser's responsibility is to protect the overall public trust and it is the importance of the role of the appraiser
158 that places ethical obligations on those who serve in this capacity. USPAP reflects the current standards of the
159 appraisal profession.

160 USPAP does not establish who or which assignments must comply. Neither The Appraisal Foundation nor its
161 Appraisal Standards Board is a government entity with the power to make, judge, or enforce law. Compliance
162 with USPAP is required when either the service or the appraiser is obligated to comply by law or regulation, or
163 by agreement with the client or intended users. When not obligated, individuals may still choose to comply.

164 USPAP addresses the ethical and performance obligations of appraisers through DEFINITIONS, Rules,
165 Standards, Standards Rules, and Statements.

- 166 • The DEFINITIONS establish the application of certain terminology in USPAP.
- 167 • The ETHICS RULE sets forth the requirements for integrity, impartiality, objectivity,
168 independent judgment, and ethical conduct.
- 169 • The RECORD KEEPING RULE establishes the workfile requirements for appraisal,
170 appraisal review, and appraisal consulting assignments.
- 171 • The COMPETENCY RULE presents pre-assignment and assignment conditions for
172 knowledge and experience.
- 173 • The SCOPE OF WORK RULE presents obligations related to problem identification,
174 research and analyses.
- 175 • The JURISDICTIONAL EXCEPTION RULE preserves the balance of USPAP if a
176 portion is contrary to law or public policy of a jurisdiction.
- 177 • The ten Standards establish the requirements for appraisal, appraisal review, and appraisal
178 consulting service and the manner in which each is communicated.
 - 179 - STANDARDS 1 and 2 establish requirements for the development and
180 communication of a real property appraisal.
 - 181 - STANDARD 3 establishes requirements for the development and communication of
182 an appraisal review.
 - 183 - STANDARDS 4 and 5 establish requirements for the development and
184 communication of a real property appraisal consulting assignment.
 - 185 - STANDARD 6 establishes requirements for the development and communication of
186 a mass appraisal.
 - 187 - STANDARDS 7 and 8 establish requirements for the development and
188 communication of a personal property appraisal.
 - 189 - STANDARDS 9 and 10 establish requirements for the development and
190 communication of a business or intangible asset appraisal.
- 191 • Statements on Appraisal Standards clarify, interpret, explain, or elaborate on a Rule or
192 Standards Rule.
- 193 • Comments are an integral part of USPAP and have the same weight as the component
194 they address. These extensions of the DEFINITIONS, Rules, and Standards Rules
195 provide interpretation and establish the context and conditions for application.

196 ETHICS RULE

197 **An appraiser must promote and preserve the public trust inherent in appraisal practice by observing**
198 **the highest standards of professional ethics.**

199 **An appraiser must comply with USPAP when obligated by law or regulation, or by agreement with**
200 **the client or intended users. In addition to these requirements, an individual should comply any time**
201 **that individual represents that he or she is performing the service as an appraiser.**

202 Comment: This Rule specifies the personal obligations and responsibilities of the individual
203 appraiser. An individual appraiser employed by a group or organization that conducts itself in a
204 manner that does not conform to USPAP should take steps that are appropriate under the
205 circumstances to ensure compliance with USPAP.

206 This ETHICS RULE is divided into three sections: Conduct, Management, and Confidentiality
207 which apply to all appraisal practice.

208 **Conduct:**

209 **An appraiser must perform assignments with impartiality, objectivity, and independence, and**
210 **without accommodation of personal interests.**

211 **An appraiser:**

- 212 • **must not perform an assignment with bias;**
- 213 • **must not advocate the cause or interest of any party or issue;**
- 214 • **must not accept an assignment that includes the reporting of predetermined opinions and**
215 **conclusions;**
- 216 • **must not misrepresent his or her role when providing valuation services that are outside of**
217 **appraisal practice;**
- 218 • **must not communicate assignment results with the intent to mislead or to defraud;**
- 219 • **must not use or communicate a report that is known by the appraiser to be misleading or**
220 **fraudulent;**
- 221 • **must not knowingly permit an employee or other person to communicate a misleading or**
222 **fraudulent report;**
- 223 • **must not use or rely on unsupported conclusions relating to characteristics such as race,**
224 **color, religion, national origin, gender, marital status, familial status, age, receipt of public**
225 **assistance income, handicap, or an unsupported conclusion that homogeneity of such**
226 **characteristics is necessary to maximize value;**
- 227 • **must not engage in criminal conduct;**
- 228 • **must not willfully or knowingly violate the requirements of the RECORD KEEPING RULE; and**
- 229 • **must not perform an assignment in a grossly negligent manner.**

230 Comment: Development standards (1-1, 3-1, 4-1, 6-1, 7-1 and 9-1) address the requirement that
231 “an appraiser must not render appraisal services in a careless or negligent manner.” The above
232 requirement deals with an appraiser being grossly negligent in performing an assignment which
233 would be a violation of the Conduct section of the ETHICS RULE.

ETHICS RULE

234 **If known prior to accepting an assignment, and/or if discovered at any time during the assignment,**
235 **an appraiser must disclose to the client, and in the subsequent report certification:**

- 236 • **any current or prospective interest in the subject property or parties involved; and**
237 • **any services regarding the subject property performed by the appraiser within the three**
238 **year period immediately preceding acceptance of the assignment, as an appraiser or in any**
239 **other capacity.**

240 Comment: Disclosing the fact that the appraiser has previously appraised the property is permitted
241 except in the case when an appraiser has agreed with the client to keep the mere occurrence of a
242 prior assignment confidential. If an appraiser has agreed with a client not to disclose that he or she
243 has appraised a property, the appraiser must decline all subsequent assignments that fall within the
244 three year period.

245 **Management:**

246 **An appraiser must disclose that he or she paid a fee or commission, or gave a thing of value in**
247 **connection with the procurement of an assignment.**

248 Comment: The disclosure must appear in the certification and in any transmittal letter in which
249 conclusions are stated; however, disclosure of the amount paid is not required. In groups or
250 organizations engaged in appraisal practice, intra-company payments to employees for business
251 development do not require disclosure.

252 **An appraiser must not accept an assignment, or have a compensation arrangement for an**
253 **assignment, that is contingent on any of the following:**

- 254 1. **the reporting of a predetermined result (e.g., opinion of value);**
255 2. **a direction in assignment results that favors the cause of the client;**
256 3. **the amount of a value opinion;**
257 4. **the attainment of a stipulated result (e.g., that the loan closes, or taxes are reduced); or**
258 5. **the occurrence of a subsequent event directly related to the appraiser's opinions and specific**
259 **to the assignment's purpose.**

260 **An appraiser must not advertise for or solicit assignments in a manner that is false, misleading, or**
261 **exaggerated.**

262 **An appraiser must affix, or authorize the use of, his or her signature to certify recognition and**
263 **acceptance of his or her USPAP responsibilities in an appraisal, appraisal review, or appraisal**
264 **consulting assignment (see Standards Rules 2-3, 3-6, 5-3, 6-9, 8-3, and 10-3). An appraiser may**
265 **authorize the use of his or her signature only on an assignment-by-assignment basis.**

266 **An appraiser must not affix the signature of another appraiser without his or her consent.**

267 Comment: An appraiser must exercise due care to prevent unauthorized use of his or her signature.
268 An appraiser exercising such care is not responsible for unauthorized use of his or her signature.

269 **Confidentiality:**

270 **An appraiser must protect the confidential nature of the appraiser-client relationship.**

271 **An appraiser must act in good faith with regard to the legitimate interests of the client in the use of**
272 **confidential information and in the communication of assignment results.**

273 **An appraiser must be aware of, and comply with, all confidentiality and privacy laws and regulations**
274 **applicable in an assignment.²**

275 **An appraiser must not disclose: (1) confidential information; or (2) assignment results to anyone**
276 **other than:**

- 277 • **the client;**
- 278 • **persons specifically authorized by the client;**
- 279 • **state appraiser regulatory agencies;**
- 280 • **third parties as may be authorized by due process of law; or**
- 281 • **a duly authorized professional peer review committee except when such disclosure to a**
282 **committee would violate applicable law or regulation.**

283 **A member of a duly authorized professional peer review committee must not disclose confidential**
284 **information presented to the committee.**

285 Comment: When all confidential elements of confidential information and assignment results are
286 removed through redaction or the process of aggregation, client authorization is not required for
287 the disclosure of the remaining information, as modified.

² Pursuant to the passage of the Gramm-Leach-Bliley Act in 1999, numerous agencies have adopted privacy regulations. Such regulations are focused on the protection of information provided by consumers to those involved in financial activities “found to be closely related to banking or usual in connection with the transaction of banking.” These activities have been deemed to include “appraising real or personal property.” (Quotations are from the Federal Trade Commission, Privacy of Consumer Financial Information; Final Rule, 16 CFR Part 313.)

RECORD KEEPING RULE

288 **RECORD KEEPING RULE**

289 **An appraiser must prepare a workfile for each appraisal, or appraisal review, or appraisal consulting**
290 **assignment. A workfile must be in existence prior to the issuance of any report. A written summary of an**
291 **oral report must be added to the workfile within a reasonable time after the issuance of the oral report.**

292 **The workfile must include:**

- 293 • **the name of the client and the identity, by name or type, of any other intended users;**
- 294 • **true copies of any written reports, documented on any type of media. (A true copy is a replica of**
295 **the report transmitted to the client. A photocopy or an electronic copy of the entire report**
296 **transmitted to the client satisfies the requirement of a true copy.);**
- 297 • **summaries of all oral reports or testimony, or a transcript of testimony, including the**
298 **appraiser's signed and dated certification;**
- 299 • **all other data, information, and documentation necessary to support the appraiser's opinions**
300 **and conclusions and to show compliance with USPAP, or references to the location(s) of such**
301 **other documentation; and**
- 302 • **a workfile in support of a Restricted Use Appraisal Report must be sufficient for the appraiser**
303 **to produce a Summary Appraisal Report (for assignments communicated under STANDARDS 2**
304 **and 8) or an Appraisal Report (for assignments communicated under STANDARD 10).**

305 **An appraiser must retain the workfile for a period of at least five years after preparation or at least two**
306 **years after final disposition of any judicial proceeding in which the appraiser provided testimony related**
307 **to the assignment, whichever period expires last.**

308 **An appraiser must have custody of the workfile, or make appropriate workfile retention, access, and**
309 **retrieval arrangements with the party having custody of the workfile. This includes ensuring that a**
310 **workfile is stored in a medium that is retrievable by the appraiser throughout the prescribed record**
311 **retention period.**

312 **An appraiser having custody of a workfile must allow other appraisers with workfile obligations related**
313 **to an assignment appropriate access and retrieval for the purpose of:**

- 314 • **submission to state appraiser regulatory agencies;**
- 315 • **compliance with due process of law;**
- 316 • **submission to a duly authorized professional peer review committee; or**
- 317 • **compliance with retrieval arrangements.**

318 Comment: A workfile must be made available by the appraiser when required by a state appraiser
319 regulatory agency or due process of law.

320 **An appraiser who willfully or knowingly fails to comply with the obligations of this RECORD KEEPING**
321 **RULE is in violation of the ETHICS RULE.**

322 **COMPETENCY RULE**

323 **An appraiser must: (1) be competent to perform the assignment; (2) acquire the necessary competency to**
 324 **perform the assignment; or (3) decline or withdraw from the assignment.**

325 **Being Competent**

326 **The appraiser must determine, prior to accepting an assignment, that he or she can perform the**
 327 **assignment competently. Competency requires:**

- 328 **1. the ability to properly identify the problem to be addressed; and**
- 329 **2. the knowledge and experience to complete the assignment competently; and**
- 330 **3. recognition of, and compliance with, laws and regulations that apply to the appraiser or to the**
 331 **assignment.**

332 Comment: Competency may apply to factors such as, but not limited to, an appraiser's
 333 familiarity with a specific type of property or asset, a market, a geographic area, an intended
 334 use, specific laws and regulations, or an analytical method. If such a factor is necessary for an
 335 appraiser to develop credible assignment results, the appraiser is responsible for having the
 336 competency to address that factor or for following the steps outlined below to satisfy this
 337 COMPETENCY RULE.

338 For assignments with retrospective opinions and conclusions, the appraiser must meet the
 339 requirements of this COMPETENCY RULE at the time of the assignment, rather than the
 340 effective date.

341 **Acquiring Competency**

342 **If an appraiser determines he or she is not competent prior to accepting an assignment, the appraiser**
 343 **must:**

- 344 **1. disclose the lack of knowledge and/or experience to the client before accepting the assignment;**
- 345 **2. take all steps necessary or appropriate to complete the assignment competently; and**
- 346 **3. describe, in the report, the lack of knowledge and/or experience and the steps taken to complete**
 347 **the assignment competently.**

348 Comment: Competency can be acquired in various ways, including, but not limited to,
 349 personal study by the appraiser, association with an appraiser reasonably believed to have the
 350 necessary knowledge and/or experience, or retention of others who possess the necessary
 351 knowledge and/or experience.

352 In an assignment where geographic competency is necessary, an appraiser who is not familiar
 353 with the relevant market characteristics must acquire an understanding necessary to produce
 354 credible assignment results for the specific property type and market involved.

355 **When facts or conditions are discovered during the course of an assignment that cause an appraiser to**
 356 **determine, at that time, that he or she lacks the required knowledge and experience to complete the**
 357 **assignment competently, the appraiser must:**

- 358 **1. notify the client, and**
- 359 **2. take all steps necessary or appropriate to complete the assignment competently, and**

COMPETENCY RULE

360 **3. describe, in the report, the lack of knowledge and/or experience and the steps taken to complete**
361 **the assignment competently.**

362 **Lack of Competency**

363 If the assignment cannot be completed competently, the appraiser must decline or withdraw from the
364 assignment.

365 SCOPE OF WORK RULE³

366 For each appraisal, appraisal review, and appraisal consulting assignment, an appraiser must:

- 367 1. identify the problem to be solved;
- 368 2. determine and perform the scope of work necessary to develop credible assignment results; and
- 369 3. disclose the scope of work in the report.

370 An appraiser must properly identify the problem to be solved in order to determine the appropriate
 371 scope of work. The appraiser must be prepared to demonstrate that the scope of work is sufficient to
 372 produce credible assignment results.

373 Comment: Scope of work includes, but is not limited to:

- 374 • the extent to which the property is identified;
- 375 • the extent to which tangible property is inspected;
- 376 • the type and extent of data researched; and
- 377 • the type and extent of analyses applied to arrive at opinions or conclusions.

378 Appraisers have broad flexibility and significant responsibility in determining the appropriate
 379 scope of work for an appraisal, appraisal review, and appraisal consulting assignment.

380 Credible assignment results require support by relevant evidence and logic. The credibility of
 381 assignment results is always measured in the context of the intended use.

382 **Problem Identification**

383 An appraiser must gather and analyze information about those assignment elements that are necessary to
 384 properly identify the appraisal, appraisal review or appraisal consulting problem to be solved.

385 Comment: The assignment elements necessary for problem identification are addressed in the
 386 applicable Standards Rules (i.e., SR 1-2, SR 3-1, SR 4-2, SR 6-2, SR 7-2 and SR 9-2). In an
 387 appraisal assignment, for example, identification of the problem to be solved requires the
 388 appraiser to identify the following assignment elements:

- 389 • client and any other intended users;
- 390 • intended use of the appraiser's opinions and conclusions;
- 391 • type and definition of value;
- 392 • effective date of the appraiser's opinions and conclusions;
- 393 • subject of the assignment and its relevant characteristics; and
- 394 • assignment conditions.

395 This information provides the appraiser with the basis for determining the type and extent of
 396 research and analyses to include in the development of an appraisal. Similar information is
 397 necessary for problem identification in appraisal review and appraisal consulting assignments.

398 Communication with the client is required to establish most of the information necessary for
 399 problem identification. However, the identification of relevant characteristics is a judgment
 400 made by the appraiser that requires competency in that type of assignment.

³ See Advisory Opinion 28, *Scope of Work Decision, Performance, and Disclosure* and Advisory Opinion 29, *An Acceptable Scope of Work*.

SCOPE OF WORK RULE

401 Assignment conditions include assumptions, extraordinary assumptions, hypothetical
402 conditions, laws and regulations, jurisdictional exceptions, and other conditions that affect the
403 scope of work. Laws include constitutions, legislative and court-made law, administrative
404 rules, and ordinances. Regulations include rules or orders, having legal force, issued by an
405 administrative agency.

406 Scope of Work Acceptability⁴

407 **The scope of work must include the research and analyses that are necessary to develop credible**
408 **assignment results.**

409 Comment: The scope of work is acceptable when it meets or exceeds:

- 410 • the expectations of parties who are regularly intended users for similar assignments; and
- 411 • what an appraiser's peers' actions would be in performing the same or a similar
412 assignment.

413 Determining the scope of work is an ongoing process in an assignment. Information or
414 conditions discovered during the course of an assignment might cause the appraiser to
415 reconsider the scope of work.

416 An appraiser must be prepared to support the decision to exclude any investigation,
417 information, method, or technique that would appear relevant to the client, another intended
418 user, or the appraiser's peers.

419 **An appraiser must not allow assignment conditions to limit the scope of work to such a degree that the**
420 **assignment results are not credible in the context of the intended use.**

421 Comment: If relevant information is not available because of assignment conditions that limit
422 research opportunities (such as conditions that place limitations on inspection or information
423 gathering), an appraiser must withdraw from the assignment unless the appraiser can:

- 424 • modify the assignment conditions to expand the scope of work to include gathering the
425 information; or
- 426 • use an extraordinary assumption about such information, if credible assignment results
427 can still be developed.

428 **An appraiser must not allow the intended use of an assignment or a client's objectives to cause the**
429 **assignment results to be biased.**

430 Disclosure Obligations

431 **The report must contain sufficient information to allow intended users to understand the scope of work**
432 **performed.**

433 Comment: Proper disclosure is required because clients and other intended users rely on the
434 assignment results. Sufficient information includes disclosure of research and analyses
435 performed and might also include disclosure of research and analyses not performed.

⁴ See Advisory Opinion 29, *An Acceptable Scope of Work*.

436 **JURISDICTIONAL EXCEPTION RULE**

437 **If any applicable law or regulation precludes compliance with any part of USPAP, only that part of**
438 **USPAP becomes void for that assignment.**

439 Comment: When compliance with USPAP is required by federal law or regulation, no part of
440 USPAP can be voided by a law or regulation of a state or local jurisdiction.

441 **In an assignment involving a jurisdictional exception, an appraiser must:**

- 442 **1. identify the law or regulation that precludes compliance with USPAP;**
- 443 **2. comply with that law or regulation;**
- 444 **3. clearly and conspicuously disclose in the report the part of USPAP that is voided by that law**
445 **or regulation; and**
- 446 **4. cite in the report the law or regulation requiring this exception to USPAP compliance.**

447 Comment: The JURISDICTIONAL EXCEPTION RULE provides a saving or severability
448 clause intended to preserve the balance of USPAP if compliance with one or more of its parts
449 is precluded by the law or regulation of a jurisdiction. When an appraiser properly follows
450 this Rule in disregarding a part of USPAP, there is no violation of USPAP.

451 Law includes constitutions, legislative and court-made law, and administrative rules and
452 ordinances. Regulations include rules or orders having legal force, issued by an
453 administrative agency. Instructions from a client or attorney do not establish a jurisdictional
454 exception.

STANDARD 1

455 STANDARD 1: REAL PROPERTY APPRAISAL, DEVELOPMENT

456 **In developing a real property appraisal, an appraiser must identify the problem to be solved, determine**
457 **the scope of work necessary to solve the problem, and correctly complete research and analyses necessary**
458 **to produce a credible appraisal.**

459 *Comment:* STANDARD 1 is directed toward the substantive aspects of developing a credible
460 appraisal of real property. The requirements set forth in STANDARD 1 follow the appraisal
461 development process in the order of topics addressed and can be used by appraisers and the
462 users of appraisal services as a convenient checklist.

463 Standards Rule 1-1

464 **In developing a real property appraisal, an appraiser must:**

465 **(a) be aware of, understand, and correctly employ those recognized methods and techniques that are**
466 **necessary to produce a credible appraisal;**

467 *Comment:* This Standards Rule recognizes that the principle of change continues to affect the
468 manner in which appraisers perform appraisal services. Changes and developments in the real
469 estate field have a substantial impact on the appraisal profession. Important changes in the
470 cost and manner of constructing and marketing commercial, industrial, and residential real
471 estate as well as changes in the legal framework in which real property rights and interests are
472 created, conveyed, and mortgaged have resulted in corresponding changes in appraisal theory
473 and practice. Social change has also had an effect on appraisal theory and practice. To keep
474 abreast of these changes and developments, the appraisal profession is constantly reviewing
475 and revising appraisal methods and techniques and devising new methods and techniques to
476 meet new circumstances. For this reason, it is not sufficient for appraisers to simply maintain
477 the skills and the knowledge they possess when they become appraisers. Each appraiser must
478 continuously improve his or her skills to remain proficient in real property appraisal.

479 **(b) not commit a substantial error of omission or commission that significantly affects an appraisal;**
480 **and**

481 *Comment:* An appraiser must use sufficient care to avoid errors that would significantly affect
482 his or her opinions and conclusions. Diligence is required to identify and analyze the factors,
483 conditions, data, and other information that would have a significant effect on the credibility
484 of the assignment results.

485 **(c) not render appraisal services in a careless or negligent manner, such as by making a series of**
486 **errors that, although individually might not significantly affect the results of an appraisal, in the**
487 **aggregate affects the credibility of those results.**

488 *Comment:* Perfection is impossible to attain, and competence does not require perfection.
489 However, an appraiser must not render appraisal services in a careless or negligent manner.
490 This Standards Rule requires an appraiser to use due diligence and due care.

491 Standards Rule 1-2

492 **In developing a real property appraisal, an appraiser must:**

- 493 (a) identify the client and other intended users;⁵
- 494 (b) identify the intended use of the appraiser's opinions and conclusions;⁶
- 495 Comment: An appraiser must not allow the intended use of an assignment or a client's
496 objectives to cause the assignment results to be biased.⁷
- 497 (c) identify the type and definition of value, and, if the value opinion to be developed is market
498 value, ascertain whether the value is to be the most probable price:
- 499 (i) in terms of cash; or
- 500 (ii) in terms of financial arrangements equivalent to cash; or
- 501 (iii) in other precisely defined terms; and
- 502 (iv) if the opinion of value is to be based on non-market financing or financing with unusual
503 conditions or incentives, the terms of such financing must be clearly identified and the
504 appraiser's opinion of their contributions to or negative influence on value must be
505 developed by analysis of relevant market data;
- 506 Comment: When exposure time is a component of the definition for the value
507 opinion being developed, the appraiser must also develop an opinion of reasonable
508 exposure time linked to that value opinion.⁸
- 509 (d) identify the effective date of the appraiser's opinions and conclusions;⁹
- 510 (e) identify the characteristics of the property that are relevant to the type and definition of value
511 and intended use of the appraisal,¹⁰ including:
- 512 (i) its location and physical, legal, and economic attributes;
- 513 (ii) the real property interest to be valued;
- 514 (iii) any personal property, trade fixtures, or intangible items that are not real property but
515 are included in the appraisal;
- 516 (iv) any known easements, restrictions, encumbrances, leases, reservations, covenants,
517 contracts, declarations, special assessments, ordinances, or other items of a similar
518 nature; and

⁵ See Statement on Appraisal Standards No. 9, *Identification of Intended Use and Intended Users*.

⁶ See Statement on Appraisal Standards No. 9, *Identification of Intended Use and Intended Users*.

⁷ See Advisory Opinion 19, *Unacceptable Assignment Conditions in Real Property Appraisal Assignments*.

⁸ See Statement on Appraisal Standards No. 6, *Reasonable Exposure Time in Real Property and Personal Property Opinions of Value*. See also Advisory Opinion 7, *Marketing Time Opinions*, and Advisory Opinion 22, *Scope of Work in Market Value Appraisal Assignments, Real Property*.

⁹ See Statement on Appraisal Standards No. 3, *Retrospective Value Opinions*, and Statement on Appraisal Standards No. 4, *Prospective Value Opinions*.

¹⁰ See Advisory Opinion 2, *Inspection of Subject Property*, and Advisory Opinion 23, *Identifying the Relevant Characteristics of the Subject Property of a Real Property Appraisal Assignment*.

STANDARD 1

519 (v) whether the subject property is a fractional interest, physical segment, or partial
520 holding;

521 Comment on (i)–(v): The information used by an appraiser to identify the property
522 characteristics must be from sources the appraiser reasonably believes are reliable.

523 An appraiser may use any combination of a property inspection and documents, such as a
524 physical legal description, address, map reference, copy of a survey or map, property sketch,
525 or photographs, to identify the relevant characteristics of the subject property.

526 When appraising proposed improvements, an appraiser must examine and have available for
527 future examination, plans, specifications, or other documentation sufficient to identify the
528 extent and character of the proposed improvements.¹¹

529 Identification of the real property interest appraised can be based on a review of copies or
530 summaries of title descriptions or other documents that set forth any known encumbrances.

531 An appraiser is not required to value the whole when the subject of the appraisal is a
532 fractional interest, a physical segment, or a partial holding.

533 (f) identify any extraordinary assumptions necessary in the assignment;

534 Comment: An extraordinary assumption may be used in an assignment only if:

- 535 • it is required to properly develop credible opinions and conclusions;
536 • the appraiser has a reasonable basis for the extraordinary assumption;
537 • use of the extraordinary assumption results in a credible analysis; and
538 • the appraiser complies with the disclosure requirements set forth in USPAP for
539 extraordinary assumptions.

540 (g) identify any hypothetical conditions necessary in the assignment; and

541 Comment: A hypothetical condition may be used in an assignment only if:

- 542 • use of the hypothetical condition is clearly required for legal purposes, for purposes of
543 reasonable analysis, or for purposes of comparison;
544 • use of the hypothetical condition results in a credible analysis; and
545 • the appraiser complies with the disclosure requirements set forth in USPAP for
546 hypothetical conditions.

547 (h) determine the scope of work necessary to produce credible assignment results in accordance with
548 the SCOPE OF WORK RULE.¹²

549 Standards Rule 1-3

550 **When necessary for credible assignment results in developing a market value opinion, an appraiser must:**

¹¹ See Advisory Opinion 17, *Appraisals of Real Property with Proposed Improvements*.

¹² See Advisory Opinion 28, *Scope of Work Decision, Performance, and Disclosure*, and Advisory Opinion 29, *An Acceptable Scope of Work*.

551 **(a) identify and analyze the effect on use and value of existing land use regulations, reasonably**
 552 **probable modifications of such land use regulations, economic supply and demand, the physical**
 553 **adaptability of the real estate, and market area trends; and**

554 Comment: An appraiser must avoid making an unsupported assumption or premise about
 555 market area trends, effective age, and remaining life.

556 **(b) develop an opinion of the highest and best use of the real estate.**

557 Comment: An appraiser must analyze the relevant legal, physical, and economic factors to the
 558 extent necessary to support the appraiser's highest and best use conclusion(s).

559 **Standards Rule 1-4**

560 **In developing a real property appraisal, an appraiser must collect, verify, and analyze all information**
 561 **necessary for credible assignment results.**

562 **(a) When a sales comparison approach is necessary for credible assignment results, an appraiser**
 563 **must analyze such comparable sales data as are available to indicate a value conclusion.**

564 **(b) When a cost approach is necessary for credible assignment results, an appraiser must:**

565 **(i) develop an opinion of site value by an appropriate appraisal method or technique;**

566 **(ii) analyze such comparable cost data as are available to estimate the cost new of the**
 567 **improvements (if any); and**

568 **(iii) analyze such comparable data as are available to estimate the difference between the**
 569 **cost new and the present worth of the improvements (accrued depreciation).**

570 **(c) When an income approach is necessary for credible assignment results, an appraiser must:**

571 **(i) analyze such comparable rental data as are available and/or the potential earnings**
 572 **capacity of the property to estimate the gross income potential of the property;**

573 **(ii) analyze such comparable operating expense data as are available to estimate the**
 574 **operating expenses of the property;**

575 **(iii) analyze such comparable data as are available to estimate rates of capitalization and/or**
 576 **rates of discount; and**

577 **(iv) base projections of future rent and/or income potential and expenses on reasonably clear**
 578 **and appropriate evidence.¹³**

579 Comment: In developing income and expense statements and cash flow projections,
 580 an appraiser must weigh historical information and trends, current supply and
 581 demand factors affecting such trends, and anticipated events such as competition
 582 from developments under construction.

583 **(d) When developing an opinion of the value of a leased fee estate or a leasehold estate, an appraiser**
 584 **must analyze the effect on value, if any, of the terms and conditions of the lease(s).**

¹³ See Statement on Appraisal Standards No. 2, *Discounted Cash Flow Analysis*.

STANDARD 1

585 (e) **When analyzing the assemblage of the various estates or component parts of a property, an**
586 **appraiser must analyze the effect on value, if any, of the assemblage. An appraiser must refrain**
587 **from valuing the whole solely by adding together the individual values of the various estates or**
588 **component parts.**

589 Comment: Although the value of the whole may be equal to the sum of the separate estates or
590 parts, it also may be greater than or less than the sum of such estates or parts. Therefore, the
591 value of the whole must be tested by reference to appropriate data and supported by an
592 appropriate analysis of such data.

593 A similar procedure must be followed when the value of the whole has been established and
594 the appraiser seeks to value a part. The value of any such part must be tested by reference to
595 appropriate data and supported by an appropriate analysis of such data.

596 (f) **When analyzing anticipated public or private improvements, located on or off the site, an**
597 **appraiser must analyze the effect on value, if any, of such anticipated improvements to the extent**
598 **they are reflected in market actions.**

599 (g) **When personal property, trade fixtures, or intangible items are included in the appraisal, the**
600 **appraiser must analyze the effect on value of such non-real property items.**

601 Comment: When the scope of work includes an appraisal of personal property, trade fixtures
602 or intangible items, competency in personal property appraisal (see STANDARD 7) or
603 business appraisal (see STANDARD 9) is required.

604 Standards Rule 1-5

605 **When the value opinion to be developed is market value, an appraiser must, if such information is**
606 **available to the appraiser in the normal course of business:¹⁴**

607 (a) **analyze all agreements of sale, options, and listings of the subject property current as of the**
608 **effective date of the appraisal; and**

609 (b) **analyze all sales of the subject property that occurred within the three (3) years prior to the**
610 **effective date of the appraisal.¹⁵**

611 Comment: See the Comments to Standards Rules 2-2(a)(viii), 2-2(b)(viii), and 2-2(c)(viii) for
612 corresponding reporting requirements relating to the availability and relevance of information.

613 Standards Rule 1-6

614 **In developing a real property appraisal, an appraiser must:**

615 (a) **reconcile the quality and quantity of data available and analyzed within the approaches used;**
616 **and**

¹⁴ See Advisory Opinion 24, *Normal Course of Business*.

¹⁵ See Advisory Opinion 1, *Sales History*.

- 617 (b) reconcile the applicability and relevance of the approaches, methods and techniques used to
618 arrive at the value conclusion(s).

STANDARD 2

619 STANDARD 2: REAL PROPERTY APPRAISAL, REPORTING

620 **In reporting the results of a real property appraisal, an appraiser must communicate each analysis,**
621 **opinion, and conclusion in a manner that is not misleading.**

622 Comment: STANDARD 2 addresses the content and level of information required in a report
623 that communicates the results of a real property appraisal.

624 STANDARD 2 does not dictate the form, format, or style of real property appraisal reports.
625 The form, format, and style of a report are functions of the needs of intended users and
626 appraisers. The substantive content of a report determines its compliance.

627 Standards Rule 2-1

628 **Each written or oral real property appraisal report must:**

- 629 (a) **clearly and accurately set forth the appraisal in a manner that will not be misleading;**
- 630 (b) **contain sufficient information to enable the intended users of the appraisal to understand the**
631 **report properly; and**
- 632 (c) **clearly and accurately disclose all assumptions, extraordinary assumptions, hypothetical**
633 **conditions, and limiting conditions used in the assignment.**

634 Standards Rule 2-2

635 **Each written real property appraisal report must be prepared under one of the following three options**
636 **and prominently state which option is used: Self-Contained Appraisal Report, Summary Appraisal**
637 **Report, or Restricted Use Appraisal Report.¹⁶**

638 Comment: When the intended users include parties other than the client, either a Self-
639 Contained Appraisal Report or a Summary Appraisal Report must be provided. When the
640 intended users do not include parties other than the client, a Restricted Use Appraisal Report
641 may be provided.

642 The essential difference among these three options is in the content and level of information
643 provided. The appropriate reporting option and the level of information necessary in the
644 report are dependent on the intended use and the intended users.

645 An appraiser must use care when characterizing the type of report and level of information
646 communicated upon completion of an assignment. An appraiser may use any other label in
647 addition to, but not in place of, the label set forth in this Standard for the type of report
648 provided.

649 The report content and level of information requirements set forth in this Standard are
650 minimums for each type of report. An appraiser must supplement a report form, when
651 necessary, to ensure that any intended user of the appraisal is not misled and that the report
652 complies with the applicable content requirements set forth in this Standards Rule.

¹⁶ See Advisory Opinion 11, *Content of the Appraisal Report Options of Standards Rules 2-2 and 8-2*, and Advisory Opinion 12, *Use of the Appraisal Report Options of Standards Rules 2-2 and 8-2*.

653 A party receiving a copy of a Self-Contained Appraisal Report, Summary Appraisal Report, or
 654 Restricted Use Appraisal Report in order to satisfy disclosure requirements does not become
 655 an intended user of the appraisal unless the appraiser identifies such party as an intended user
 656 as part of the assignment.

657 **(a) The content of a Self-Contained Appraisal Report must be consistent with the intended use of the**
 658 **appraisal and, at a minimum:**

659 **(i) state the identity of the client and any intended users, by name or type;¹⁷**

660 Comment: An appraiser must use care when identifying the client to ensure a clear
 661 understanding and to avoid violations of the Confidentiality section of the ETHICS
 662 RULE. In those rare instances when the client wishes to remain anonymous, an
 663 appraiser must still document the identity of the client in the workfile but may omit
 664 the client's identity in the report.

665 Intended users of the report might include parties such as lenders, employees of
 666 government agencies, partners of a client, and a client's attorney and accountant.

667 **(ii) state the intended use of the appraisal;¹⁸**

668 **(iii) describe information sufficient to identify the real estate involved in the appraisal,**
 669 **including the physical and economic property characteristics relevant to the**
 670 **assignment;¹⁹**

671 Comment: The real estate involved in the appraisal can be specified, for example, by
 672 a legal description, address, map reference, copy of a survey or map, property sketch
 673 and/or photographs or the like. The information can include a property sketch and
 674 photographs in addition to written comments about the legal, physical, and economic
 675 attributes of the real estate relevant to the type and definition of value and intended
 676 use of the appraisal.

677 **(iv) state the real property interest appraised;**

678 Comment: The statement of the real property rights being appraised must be
 679 substantiated, as needed, by copies or summaries of title descriptions or other
 680 documents that set forth any known encumbrances.

681 **(v) state the type and definition of value and cite the source of the definition;**

682 Comment: Stating the definition of value also requires any comments needed to
 683 clearly indicate to the intended users how the definition is being applied.

684 When reporting an opinion of market value, state whether the opinion of value is:

- 685 • in terms of cash or of financing terms equivalent to cash, or
- 686 • based on non-market financing or financing with unusual conditions or
- 687 incentives.

¹⁷ See Statement on Appraisal Standards No. 9, *Identification of Intended Use and Intended Users*.

¹⁸ See Statement on Appraisal Standards No. 9, *Identification of Intended Use and Intended Users*.

¹⁹ See Advisory Opinion 2, *Inspection of Subject Property*, and Advisory Opinion 23, *Identifying the Relevant Characteristics of the Subject Property of a Real Property Appraisal Assignment*.

STANDARD 2

688 When an opinion of market value is not in terms of cash or based on financing terms
689 equivalent to cash, summarize the terms of such financing and explain their
690 contributions to or negative influence on value.

691 When an opinion of reasonable exposure time has been developed in compliance
692 with Standards Rule 1-2(c), the opinion must be stated in the report.²⁰

693 **(vi) state the effective date of the appraisal and the date of the report;**²¹

694 Comment: The effective date of the appraisal establishes the context for the value
695 opinion, while the date of the report indicates whether the perspective of the
696 appraiser on the market and property as of the effective date of the appraisal was
697 prospective, current, or retrospective.

698 **(vii) describe the scope of work used to develop the appraisal;**²²

699 Comment: Because intended users' reliance on an appraisal may be affected by the
700 scope of work, the report must enable them to be properly informed and not misled.
701 Sufficient information includes disclosure of research and analyses performed and
702 might also include disclosure of research and analyses not performed.

703 When any portion of the work involves significant real property appraisal assistance,
704 the appraiser must describe the extent of that assistance. The signing appraiser must
705 also state the name(s) of those providing the significant real property appraisal
706 assistance in the certification, in accordance with Standards Rule 2-3.²³

707 **(viii) describe the information analyzed, the appraisal methods and techniques employed, and**
708 **the reasoning that supports the analyses, opinions, and conclusions; exclusion of the**
709 **sales comparison approach, cost approach, or income approach must be explained;**

710 Comment: A Self-Contained Appraisal Report must include sufficient information to
711 indicate that the appraiser complied with the requirements of STANDARD 1. The
712 amount of detail required will vary with the significance of the information to the
713 appraisal.

714 The appraiser must provide sufficient information to enable the client and intended
715 users to understand the rationale for the opinions and conclusions, including
716 reconciliation of the data and approaches, in accordance with Standards Rule 1-6.

717 When reporting an opinion of market value, a summary of the results of analyzing
718 the subject sales, options, and listings in accordance with Standards Rule 1-5 is
719 required.²⁴ If such information is unobtainable, a statement on the efforts undertaken
720 by the appraiser to obtain the information is required. If such information is

²⁰ See Statement on Appraisal Standards No. 6, *Reasonable Exposure Time in Real Property and Personal Property Opinions of Value*. See also Advisory Opinion 7, *Marketing Time Opinions*, and Advisory Opinion 22, *Scope of Work in Market Value Appraisal Assignments, Real Property*.

²¹ See Statement on Appraisal Standards No. 3, *Retrospective Value Opinions*, and Statement on Appraisal Standards No. 4, *Prospective Value Opinions*.

²² See Advisory Opinion 28, *Scope of Work Decision, Performance, and Disclosure* and Advisory Opinion 29, *An Acceptable Scope of Work*.

²³ See Advisory Opinion 31, *Assignments Involving More than One Appraiser*.

²⁴ See Advisory Opinion 1, *Sales History*.

721 irrelevant, a statement acknowledging the existence of the information and citing its
722 lack of relevance is required.

723 **(ix) state the use of the real estate existing as of the date of value and the use of the real**
724 **estate reflected in the appraisal; and, when an opinion of highest and best use was**
725 **developed by the appraiser, describe the support and rationale for that opinion;**

726 **(x) clearly and conspicuously:**

- 727 • state all extraordinary assumptions and hypothetical conditions; and
- 728 • state that their use might have affected the assignment results; and

729 **(xi) include a signed certification in accordance with Standards Rule 2-3.**

730 **(b) The content of a Summary Appraisal Report must be consistent with the intended use of the**
731 **appraisal and, at a minimum:**

732 Comment: The essential difference between the Self-Contained Appraisal Report and the
733 Summary Appraisal Report is the level of detail of presentation.

734 **(i) state the identity of the client and any intended users, by name or type;²⁵**

735 Comment: An appraiser must use care when identifying the client to ensure a clear
736 understanding and to avoid violations of the Confidentiality section of the ETHICS
737 RULE. In those rare instances when the client wishes to remain anonymous, an
738 appraiser must still document the identity of the client in the workfile but may omit
739 the client's identity in the report.

740 Intended users of the report might include parties such as lenders, employees of
741 government agencies, partners of a client, and a client's attorney and accountant.

742 **(ii) state the intended use of the appraisal;²⁶**

743 **(iii) summarize information sufficient to identify the real estate involved in the appraisal,**
744 **including the physical and economic property characteristics relevant to the**
745 **assignment;²⁷**

746 Comment: The real estate involved in the appraisal can be specified, for example, by
747 a legal description, address, map reference, copy of a survey or map, property sketch,
748 and/or photographs or the like. The summarized information can include a property
749 sketch and photographs in addition to written comments about the legal, physical,
750 and economic attributes of the real estate relevant to the type and definition of value
751 and intended use of the appraisal.

752 **(iv) state the real property interest appraised;**

²⁵ See Statement on Appraisal Standards No. 9, *Identification of Intended Use and Intended Users*.

²⁶ See Statement on Appraisal Standards No. 9, *Identification of Intended Use and Intended Users*.

²⁷ See Advisory Opinion 2, *Inspection of Subject Property*, and Advisory Opinion 23, *Identifying the Relevant Characteristics of the Subject Property of a Real Property Appraisal Assignment*.

STANDARD 2

753 Comment: The statement of the real property rights being appraised must be
754 substantiated, as needed, by copies or summaries of title descriptions or other
755 documents that set forth any known encumbrances.

756 **(v) state the type and definition of value and cite the source of the definition;**

757 Comment: Stating the definition of value also requires any comments needed to
758 clearly indicate to the intended users how the definition is being applied.

759 When reporting an opinion of market value, state whether the opinion of value is:

- 760 • in terms of cash or of financing terms equivalent to cash, or
761 • based on non-market financing or financing with unusual conditions or
762 incentives.

763 When an opinion of market value is not in terms of cash or based on financing terms
764 equivalent to cash, summarize the terms of such financing and explain their
765 contributions to or negative influence on value.

766 When an opinion of reasonable exposure time has been developed in compliance
767 with Standards Rule 1-2(c), the opinion must be stated in the report.²⁸

768 **(vi) state the effective date of the appraisal and the date of the report;**²⁹

769 Comment: The effective date of the appraisal establishes the context for the value
770 opinion, while the date of the report indicates whether the perspective of the
771 appraiser on the market and property as of the effective date of the appraisal was
772 prospective, current, or retrospective.

773 **(vii) summarize the scope of work used to develop the appraisal;**³⁰

774 Comment: Because intended users' reliance on an appraisal may be affected by the
775 scope of work, the report must enable them to be properly informed and not misled.
776 Sufficient information includes disclosure of research and analyses performed and
777 might also include disclosure of research and analyses not performed.

778 When any portion of the work involves significant real property appraisal assistance,
779 the appraiser must summarize the extent of that assistance. The signing appraiser
780 must also state the name(s) of those providing the significant real property appraisal
781 assistance in the certification, in accordance with Standards Rule 2-3.³¹

782 **(viii) summarize the information analyzed, the appraisal methods and techniques employed,
783 and the reasoning that supports the analyses, opinions, and conclusions; exclusion of the
784 sales comparison approach, cost approach, or income approach must be explained;**

²⁸ See Statement on Appraisal Standards No. 6, *Reasonable Exposure Time in Real Property and Personal Property Opinions of Value*. See also Advisory Opinion 7, *Marketing Time Opinions*, and Advisory Opinion 22, *Scope of Work in Market Value Appraisal Assignments, Real Property*.

²⁹ See Statement on Appraisal Standards No. 3, *Retrospective Value Opinions*, and Statement on Appraisal Standards No. 4, *Prospective Value Opinions*.

³⁰ See Advisory Opinion 28, *Scope of Work Decision, Performance, and Disclosure*, and Advisory Opinion 29, *An Acceptable Scope of Work*.

³¹ See Advisory Opinion 31, *Assignments Involving More than One Appraiser*.

785 Comment: A Summary Appraisal Report must include sufficient information to
 786 indicate that the appraiser complied with the requirements of STANDARD 1. The
 787 amount of detail required will vary with the significance of the information to the
 788 appraisal.

789 The appraiser must provide sufficient information to enable the client and intended
 790 users to understand the rationale for the opinions and conclusions, including
 791 reconciliation of the data and approaches, in accordance with Standards Rule 1-6.

792 When reporting an opinion of market value, a summary of the results of analyzing
 793 the subject sales, options, and listings in accordance with Standards Rule 1-5 is
 794 required.³² If such information is unobtainable, a statement on the efforts undertaken
 795 by the appraiser to obtain the information is required. If such information is
 796 irrelevant, a statement acknowledging the existence of the information and citing its
 797 lack of relevance is required.

798 **(ix) state the use of the real estate existing as of the date of value and the use of the real**
 799 **estate reflected in the appraisal; and, when an opinion of highest and best use was**
 800 **developed by the appraiser, summarize the support and rationale for that opinion;**

801 **(x) clearly and conspicuously:**

- 802 • state all extraordinary assumptions and hypothetical conditions; and
- 803 • state that their use might have affected the assignment results; and

804 **(xi) include a signed certification in accordance with Standards Rule 2-3.**

805 **(c) The content of a Restricted Use Appraisal Report must be consistent with the intended use of the**
 806 **appraisal and, at a minimum:**

807 **(i) state the identity of the client, by name or type;³³ and state a prominent use restriction**
 808 **that limits use of the report to the client and warns that the appraiser's opinions and**
 809 **conclusions set forth in the report may not be understood properly without additional**
 810 **information in the appraiser's workfile;**

811 Comment: An appraiser must use care when identifying the client to ensure a clear
 812 understanding and to avoid violations of the Confidentiality section of the ETHICS
 813 RULE. In those rare instances when the client wishes to remain anonymous, an
 814 appraiser must still document the identity of the client in the workfile but may omit
 815 the client's identity in the report.

816 The Restricted Use Appraisal Report is for client use only. Before entering into an
 817 agreement, the appraiser should establish with the client the situations where this
 818 type of report is to be used and should ensure that the client understands the
 819 restricted utility of the Restricted Use Appraisal Report.

820 **(ii) state the intended use of the appraisal;³⁴**

³² See Advisory Opinion 1, *Sales History*

³³ See Statement on Appraisal Standards No. 9, *Identification of Intended Use and Intended Users*.

³⁴ See Statement on Appraisal Standards No. 9, *Identification of Intended Use and Intended Users*.

STANDARD 2

821 Comment: The intended use of the appraisal must be consistent with the limitation
822 on use of the Restricted Use Appraisal Report option in this Standards Rule (i.e.,
823 client use only).

824 **(iii) state information sufficient to identify the real estate involved in the appraisal;**³⁵

825 Comment: The real estate involved in the appraisal can be specified, for example, by
826 a legal description, address, map reference, copy of a survey or map, property sketch,
827 and/or photographs or the like.

828 **(iv) state the real property interest appraised;**

829 **(v) state the type of value and cite the source of its definition;**³⁶

830 Comment: When an opinion of reasonable exposure time has been developed in compliance
831 with Standards Rule 1-2(c), the opinion must be stated in the report.

832 **(vi) state the effective date of the appraisal and the date of the report;**³⁷

833 Comment: The effective date of the appraisal establishes the context for the value
834 opinion, while the date of the report indicates whether the perspective of the
835 appraiser on the market and property as of the effective date of the appraisal was
836 prospective, current, or retrospective.

837 **(vii) state the scope of work used to develop the appraisal;**³⁸

838 Comment: Because the client's reliance on an appraisal may be affected by the scope
839 of work, the report must enable them to be properly informed and not misled.
840 Sufficient information includes disclosure of research and analyses performed and
841 might also include disclosure of research and analyses not performed.

842 When any portion of the work involves significant real property appraisal assistance,
843 the appraiser must state the extent of that assistance. The signing appraiser must also
844 state the name(s) of those providing the significant real property appraisal assistance
845 in the certification, in accordance with Standards Rule 2-3.³⁹

846 **(viii) state the appraisal methods and techniques employed, state the value opinion(s) and
847 conclusion(s) reached, and reference the workfile; exclusion of the sales comparison
848 approach, cost approach, or income approach must be explained;**

849 Comment: An appraiser must maintain a specific, coherent workfile in support of a
850 Restricted Use Appraisal Report. The contents of the workfile must include sufficient

³⁵ See Advisory Opinion 2, *Inspection of Subject Property*. References to Advisory Opinions are for guidance only and do not incorporate Advisory Opinions into USPAP.

³⁶ See Statement on Appraisal Standards No. 6, *Reasonable Exposure Time in Real Property and Personal Property Opinions of Value*. See also Advisory Opinion 7, *Marketing Time Opinions*, and Advisory Opinion 22, *Scope of Work in Market Value Appraisal Assignments, Real Property*.

³⁷ See Statement on Appraisal Standards No. 3, *Retrospective Value Opinions*, and Statement on Appraisal Standards No. 4, *Prospective Value Opinions*.

³⁸ See Advisory Opinions 28, *Scope of Work Decision, Performance, and Disclosure*, and Advisory Opinion 29, *An Acceptable Scope of Work*.

³⁹ See Advisory Opinion 31, *Assignments Involving More than One Appraiser*.

851 information to indicate that the appraiser complied with the requirements of
852 STANDARD 1 and for the appraiser to produce a Summary Appraisal Report.

853 When reporting an opinion of market value, a summary of the results of analyzing
854 the subject sales, options, and listings in accordance with Standards Rule 1-5 is
855 required. If such information is unobtainable, a statement on the efforts undertaken
856 by the appraiser to obtain the information is required. If such information is
857 irrelevant, a statement acknowledging the existence of the information and citing its
858 lack of relevance is required.

859 (ix) state the use of the real estate existing as of the date of value and the use of the real
860 estate reflected in the appraisal; and, when an opinion of highest and best use was
861 developed by the appraiser, state that opinion;

862 (x) clearly and conspicuously:

- 863 • state all extraordinary assumptions and hypothetical conditions; and
- 864 • state that their use might have affected the assignment results; and

865 (xi) include a signed certification in accordance with Standards Rule 2-3.

866 **Standards Rule 2-3**

867 Each written real property appraisal report must contain a signed certification that is similar in content
868 to the following form:

869 I certify that, to the best of my knowledge and belief:

- 870 — the statements of fact contained in this report are true and correct.
- 871 — the reported analyses, opinions, and conclusions are limited only by the reported
872 assumptions and limiting conditions and are my personal, impartial, and unbiased
873 professional analyses, opinions, and conclusions.
- 874 — I have no (or the specified) present or prospective interest in the property that is the
875 subject of this report and no (or the specified) personal interest with respect to the
876 parties involved.
- 877 — I have performed no (or the specified) services, as an appraiser or in any other capacity,
878 regarding the property that is the subject of this report within the three-year period
879 immediately preceding acceptance of this assignment.
- 880 — I have no bias with respect to the property that is the subject of this report or to the
881 parties involved with this assignment.
- 882 — my engagement in this assignment was not contingent upon developing or reporting
883 predetermined results.
- 884 — my compensation for completing this assignment is not contingent upon the
885 development or reporting of a predetermined value or direction in value that favors
886 the cause of the client, the amount of the value opinion, the attainment of a stipulated
887 result, or the occurrence of a subsequent event directly related to the intended use of
888 this appraisal.
- 889 — my analyses, opinions, and conclusions were developed, and this report has been
890 prepared, in conformity with the *Uniform Standards of Professional Appraisal Practice*.
- 891 — I have (or have not) made a personal inspection of the property that is the subject of
892 this report. (If more than one person signs this certification, the certification must

STANDARD 2

893 clearly specify which individuals did and which individuals did not make a personal
894 inspection of the appraised property.)⁴⁰
895 — no one provided significant real property appraisal assistance to the person signing
896 this certification. (If there are exceptions, the name of each individual providing
897 significant real property appraisal assistance must be stated.)

898 Comment: A signed certification is an integral part of the appraisal report. An appraiser who
899 signs any part of the appraisal report, including a letter of transmittal, must also sign this
900 certification.

901 In an assignment that includes only assignment results developed by the real property
902 appraiser(s), any appraiser(s) who signs a certification accepts full responsibility for all
903 elements of the certification, for the assignment results, and for the contents of the appraisal
904 report. In an assignment that includes personal property, business or intangible asset
905 assignment results not developed by the real property appraiser(s), any real property
906 appraiser(s) who signs a certification accepts full responsibility for the real property elements
907 of the certification, for the real property assignment results, and for the real property contents
908 of the appraisal report.

909 When a signing appraiser(s) has relied on work done by appraisers and others who do not sign
910 the certification, the signing appraiser is responsible for the decision to rely on their work.
911 The signing appraiser(s) is required to have a reasonable basis for believing that those
912 individuals performing the work are competent. The signing appraiser(s) also must have no
913 reason to doubt that the work of those individuals is credible.

914 The names of individuals providing significant real property appraisal assistance who do not
915 sign a certification must be stated in the certification. It is not required that the description of
916 their assistance be contained in the certification, but disclosure of their assistance is required
917 in accordance with Standards Rule 2-2(a), (b), or (c)(vii), as applicable.⁴¹

918 **Standards Rule 2-4**

919 **To the extent that it is both possible and appropriate, an oral real property appraisal report must address**
920 **the substantive matters set forth in Standards Rule 2-2(b).**

921 Comment: See the RECORD KEEPING RULE for corresponding requirements.

⁴⁰ See Advisory Opinion 2, *Inspection of Subject Property*.

⁴¹ See Advisory Opinion 31, *Assignments Involving More than One Appraiser*.

922 **STANDARD 3: APPRAISAL REVIEW, DEVELOPMENT AND REPORTING**

923 **In developing an appraisal review assignment, an appraiser acting as a reviewer must identify the**
 924 **problem to be solved, determine the scope of work necessary to solve the problem, and correctly complete**
 925 **research and analyses necessary to produce a credible appraisal review. In reporting the results of an**
 926 **appraisal review assignment, an appraiser acting as a reviewer must communicate each analysis, opinion,**
 927 **and conclusion in a manner that is not misleading.**

928 Comment: STANDARD 3 is directed toward the substantive aspects of developing a credible
 929 opinion of the quality of another appraiser's work that was performed as part of an appraisal,
 930 appraisal review, or real property appraisal consulting assignment.

931 STANDARD 3 also addresses the content and level of information required in a report that
 932 communicates the results of an appraisal review assignment. STANDARD 3 does not dictate
 933 the form, format, or style of Appraisal Review Reports. The substantive content of a report
 934 determines its compliance.

935 In this Standard, the term "reviewer" is used to refer to an appraiser performing an appraisal
 936 review.

937 **Standards Rule 3-1**

938 **In developing an appraisal review, the reviewer must:**

939 **(a) be aware of, understand, and correctly employ those methods and techniques that are necessary**
 940 **to produce a credible appraisal review;**

941 Comment: Changes and developments in economics, finance, law, technology, and society
 942 can have a substantial impact on the appraisal profession. To keep abreast of these changes
 943 and developments, the appraisal profession is constantly reviewing and revising appraisal
 944 methods and techniques and devising new methods and techniques to meet new
 945 circumstances. Each appraiser must continuously improve his or her skills to remain
 946 proficient in appraisal review.

947 The reviewer must have the knowledge and experience needed to identify and perform the
 948 scope of work necessary to produce credible assignment results. Aspects of competency for
 949 an appraisal review, depending on the review assignment's scope of work, may include,
 950 without limitation, familiarity with the specific type of property or asset, market, geographic
 951 area, analytic method, and applicable laws, regulations and guidelines.

952 **(b) not commit a substantial error of omission or commission that significantly affects an appraisal**
 953 **review; and**

954 Comment: A reviewer must use sufficient care to avoid errors that would significantly affect
 955 his or her opinions and conclusions. Diligence is required to identify and analyze the factors,
 956 conditions, data, and other information that would have a significant effect on the credibility
 957 of the assignment results.

958 **(c) not render appraisal review services in a careless or negligent manner, such as making a series of**
 959 **errors that, although individually might not significantly affect the results of an appraisal review,**
 960 **in the aggregate affects the credibility of those results.**

STANDARD 3

961 Comment: Perfection is impossible to attain, and competence does not require perfection.
962 However, an appraiser must not render appraisal review services in a careless or negligent
963 manner. This Standards Rule requires a reviewer to use due diligence and due care.

964 Standards Rule 3-2

965 **In developing an appraisal review, the reviewer must:**

966 **(a) identify the client and other intended users;**

967 **(b) identify the intended use of the reviewer's opinions and conclusions;**

968 Comment: A reviewer must not allow the intended use of an assignment or a client's
969 objectives to cause the assignment results to be biased. A reviewer must not advocate for a
970 client's objectives.

971 The intended use refers to the use of the reviewer's opinions and conclusions by the client and
972 other intended users; examples include, without limitation, quality control, audit,
973 qualification, or confirmation.

974 **(c) identify the purpose of the appraisal review, including whether the assignment includes the
975 development of the reviewer's own opinion of value, review opinion or real property appraisal
976 consulting conclusion related to the work under review;**

977 Comment: The purpose of an appraisal review assignment relates to the reviewer's objective;
978 examples include, without limitation, to determine if the results of the work under review are
979 credible for the intended user's intended use, or to evaluate compliance with relevant USPAP
980 requirements, client requirements, or applicable regulations.

981 In the review of an appraisal assignment, the reviewer may provide an opinion of value for the
982 property that is the subject of the work under review.

983 In the review of an appraisal review assignment, the reviewer may provide an opinion of
984 quality for the work that is the subject of the appraisal review assignment.

985 In the review of an appraisal consulting assignment, the reviewer may provide an analysis,
986 recommendation, or opinion for the consulting problem that is the subject of the real property
987 appraisal consulting assignment.

988 **(d) identify the work under review and the characteristics of that work which are relevant to the
989 intended use and purpose of the appraisal review, including:**

990 **(i) any ownership interest in the property that is the subject of the work under review;**

991 **(ii) the date of the work under review and the effective date of the opinions or conclusions in
992 the work under review;**

993 **(iii) the appraiser(s) who completed the work under review, unless the identity is withheld by
994 the client; and**

995 **(iv) the physical, legal, and economic characteristics of the property, properties, property
996 type(s), or market area in the work under review.**

997 Comment: The subject of an appraisal review assignment may be all or part of a report, a
998 workfile, or a combination of these, and may be related to an appraisal, appraisal review, or
999 appraisal consulting assignment.

1000 (e) **identify the effective date of the reviewer’s opinions and conclusions;**

1001 (f) **identify any extraordinary assumptions necessary in the review assignment;**

1002 Comment: An extraordinary assumption may be used in a review assignment only if:

- 1003 • it is required to properly develop credible opinions and conclusions;
- 1004 • the reviewer has a reasonable basis for the extraordinary assumption;
- 1005 • use of the extraordinary assumption results in a credible analysis; and
- 1006 • the reviewer complies with the disclosure requirements set forth in USPAP for
- 1007 extraordinary assumptions.

1008 (g) **identify any hypothetical conditions necessary in the review assignment; and**

1009 Comment: A hypothetical condition may be used in a review assignment only if:

- 1010 • use of the hypothetical condition is clearly required for legal purposes, for purposes of
- 1011 reasonable analysis, or for purposes of comparison;
- 1012 • use of the hypothetical condition results in a credible analysis; and
- 1013 • the reviewer complies with the disclosure requirements set forth in USPAP for
- 1014 hypothetical conditions

1015 (h) **determine the scope of work necessary to produce credible assignment results in accordance with**
1016 **the SCOPE OF WORK RULE.**

1017 Comment: Reviewers have broad flexibility and significant responsibility in determining the
1018 appropriate scope of work in an appraisal review assignment.

1019 Information that should have been considered by the original appraiser can be used by the
1020 reviewer in developing an opinion as to the quality of the work under review.

1021 Information that was not available to the original appraiser in the normal course of business
1022 may also be used by the reviewer; however, the reviewer must not use such information in the
1023 reviewer’s development of an opinion as to the quality of the work under review.

1024 Standards Rule 3-3

1025 **In developing an appraisal review, a reviewer must apply the appraisal review methods and techniques**
1026 **that are necessary for credible assignment results.**

1027 (a) **When necessary for credible assignment results in the review of analyses, opinions, and**
1028 **conclusions, the reviewer must:**

1029 (i) **develop an opinion as to whether the analyses are appropriate within the context of the**
1030 **requirements applicable to that work;**

1031 (ii) **develop an opinion as to whether the opinions and conclusions are credible within the**
1032 **context of the requirements applicable to that work; and**

1033 (iii) **develop the reasons for any disagreement.**

1034
1035 Comment: Consistent with the reviewer’s scope of work, the reviewer is required to develop
1036 an opinion as to the completeness, accuracy, adequacy, relevance, and reasonableness of the
1037 analysis in the work under review, given law, regulations, or intended user requirements
1038 applicable to the work under review.

STANDARD 3

1039 **(b) When necessary for credible assignment results in the review of a report, the reviewer must:**

1040 **(i) develop an opinion as to whether the report is appropriate and not misleading within the**
1041 **context of the requirements applicable to that work; and**

1042 **(ii) develop the reasons for any disagreement.**

1043 Comment: Consistent with the reviewer's scope of work, the reviewer is required to develop
1044 an opinion as to the completeness, accuracy, adequacy, relevance, and reasonableness of the
1045 report, given law, regulations, or intended user requirements applicable to that work.

1046

1047 **(c) When the scope of work includes the reviewer developing his or her own opinion of value, review**
1048 **opinion, or real property appraisal consulting conclusion, the reviewer must comply with the**
1049 **Standard applicable to the development of that opinion.**

1050 **(i) The requirements of STANDARDS 1, 6, 7, and 9 apply to the reviewer's opinion of value**
1051 **for the property that is the subject of the appraisal review assignment.**

1052 **(ii) The requirements of STANDARD 3 apply to the reviewer's opinion of quality for the**
1053 **work that is the subject of the appraisal review assignment.**

1054 **(iii) The requirements of STANDARD 4 apply to the reviewer's analysis, recommendation,**
1055 **or opinion for the consulting problem that is the subject of the appraisal consulting**
1056 **assignment.**

1057 Comment: These requirements apply to:

- 1058 • The reviewer's own opinion of value when the subject of the review is the product of an
1059 appraisal assignment;
- 1060 • The reviewer's own opinion regarding the work reviewed by another when the subject of
1061 the review is the product of an appraisal review assignment; or
- 1062 • The reviewer's own appraisal consulting conclusion when the subject of the review is the
1063 product of an appraisal consulting assignment.

1064 These requirements apply whether the reviewer's own opinion:

- 1065 • concurs with the opinions and conclusions in the work under review; or
1066 • differs from the opinion and conclusions in the work under review.

1067 When the appraisal review scope of work includes the reviewer developing his or her own
1068 opinion of value, review opinion or real property appraisal consulting conclusion, the
1069 following apply:

- 1070 • The reviewer's scope of work in developing his or her own opinion of value, review
1071 opinion, or real property appraisal consulting conclusion may be different from that of the
1072 work under review.
- 1073 • The effective date of the appraisal, appraisal review, or appraisal consulting opinions and
1074 conclusions may be the same or different from the effective date of the work under
1075 review.
- 1076 • The reviewer is not required to replicate the steps completed by the original appraiser.
1077 Those items in the work under review that the reviewer concludes are credible can be
1078 extended to the reviewer's development process on the basis of an extraordinary
1079 assumption. Those items not deemed to be credible must be replaced with information or
1080 analysis developed in conformance with STANDARD 1, 3, 4, 6, 7, or 9, as applicable, to
1081 produce credible assignment results.

1082 **Standards Rule 3-4**1083 **Each written or oral Appraisal Review Report must be separate from the work under review and must:**

- 1084 **(a) clearly and accurately set forth the appraisal review in a manner that will not be misleading;**
 1085 **(b) contain sufficient information to enable the intended users of the appraisal review to understand**
 1086 **the report properly; and**
 1087 **(c) clearly and accurately disclose all assumptions, extraordinary assumptions, and hypothetical**
 1088 **conditions used in the assignment.**

1089 Comment: An Appraisal Review Report communicates the results of an appraisal review,
 1090 which can have as its subject another appraiser's work in an appraisal, appraisal review, or
 1091 appraisal consulting assignment.

1092 The report content and level of information in the Appraisal Review Report is specific to the
 1093 needs of the client, other intended users, the intended use, and requirements applicable to the
 1094 assignment. The reporting requirements set forth in this Standard are the minimum for an
 1095 Appraisal Review Report.

1096 **Standards Rule 3-5**1097 **The content of an Appraisal Review Report must be consistent with the intended use of the appraisal**
1098 **review and, at a minimum:**

- 1099 **(a) state the identity of the client and any intended users, by name or type;**
 1100 **(b) state the intended use of the appraisal review;**
 1101 **(c) state the purpose of the appraisal review;**
 1102 **(d) state information sufficient to identify:**
 1103 **(i) the work under review, including any ownership interest in the property that is the**
 1104 **subject of the work under review;**
 1105 **(ii) the date of the work under review;**
 1106 **(iii) the effective date of the opinions or conclusions in the work under review; and**
 1107 **(iv) the appraiser(s) who completed the work under review, unless the identity is withheld by**
 1108 **the client.**

1109 Comment: If the identity of the appraiser(s) in the work under review is withheld by the
 1110 client, that fact must be stated in the appraisal review report.

- 1111 **(e) state the effective date of the appraisal review;**
 1112 **(f) clearly and conspicuously:**
 1113 **• state all extraordinary assumptions and hypothetical conditions; and**
 1114 **• state that their use might have affected the assignment results.**
 1115 **(g) state the scope of work used to develop the appraisal review;**

1116 Comment: Because intended users' reliance on an appraisal review may be affected by the
 1117 scope of work, the appraisal review report must enable them to be properly informed and not

STANDARD 3

1118 misled. Sufficient information includes disclosure of research and analyses performed and
1119 might also include disclosure of research and analyses not performed.

1120 When any portion of the work involves significant appraisal, appraisal review, or appraisal
1121 consulting assistance, the reviewer must state the extent of that assistance. The signing
1122 reviewer must also state the name(s) of those providing the significant assistance in the
1123 certification, in accordance with Standards Rule 3-6.

1124 **(h) state the reviewer's opinions and conclusions about the work under review, including the reasons**
1125 **for any disagreement;**

1126 Comment: The report must provide sufficient information to enable the client and intended users to
1127 understand the rationale for the reviewer's opinions and conclusions.

1128 **(i) when the scope of work includes the reviewer's development of an opinion of value, review**
1129 **opinion, or real property appraisal consulting conclusion related to the work under review, the**
1130 **reviewer must:**

1131 **(i) state which information, analyses, opinions, and conclusions in the work under review**
1132 **that the reviewer accepted as credible and used in developing the reviewer's opinion and**
1133 **conclusions;**

1134 **(ii) at a minimum, summarize any additional information relied on and the reasoning for**
1135 **the reviewer's opinion of value, review opinion, or real property appraisal consulting**
1136 **conclusion related to the work under review;**

1137 **(iii) clearly and conspicuously:**

1138 • **state all extraordinary assumptions and hypothetical conditions connected with the**
1139 **reviewer's opinion of value, review opinion, or real property appraisal consulting**
1140 **conclusion related to the work under review; and**

1141 • **state that their use might have affected the assignment results.**

1142 Comment: The reviewer may include his or her own opinion of value, review opinion, or
1143 appraisal consulting conclusion related to the work under review within the appraisal review
1144 report itself without preparing a separate report. However, data and analyses provided by the
1145 reviewer to support a different opinion or conclusion must match, at a minimum, except for
1146 the certification requirements, the reporting requirements for a:

- 1147 • Summary Appraisal Report for a real property appraisal (Standards Rule 2-2(b));
- 1148 • Summary Appraisal Report for a personal property appraisal (Standards Rule 8-2(b));
- 1149 • Appraisal Review Report for an appraisal review (Standards Rule 3-5);
- 1150 • Appraisal Consulting Report for real property appraisal consulting (Standards Rule
1151 5-2);
- 1152 • Mass Appraisal Report for mass appraisal (Standards Rule 6-8); and
- 1153 • Appraisal Report for business appraisal (Standards Rule 10-2(a)).

1154 Standards Rule 3-6

1155 **Each written Appraisal Review Report must contain a signed certification that is similar in content to the**
1156 **following form:**

1157 **I certify that, to the best of my knowledge and belief:**

1158 — **the statements of fact contained in this report are true and correct.**

- 1159 — the reported analyses, opinions, and conclusions are limited only by the reported
 1160 assumptions and limiting conditions and are my personal, impartial, and unbiased
 1161 professional analyses, opinions, and conclusions.
 1162 — I have no (or the specified) present or prospective interest in the property that is the
 1163 subject of the work under review and no (or the specified) personal interest with
 1164 respect to the parties involved.
 1165 — I have performed no (or the specified) other services, as an appraiser or in any other
 1166 capacity, regarding the property that is the subject of the work under review within the
 1167 three-year period immediately preceding acceptance of this assignment.
 1168 — I have no bias with respect to the property that is the subject of the work under review
 1169 or to the parties involved with this assignment.
 1170 — my engagement in this assignment was not contingent upon developing or reporting
 1171 predetermined results.
 1172 — my compensation is not contingent on an action or event resulting from the analyses,
 1173 opinions, or conclusions in this review or from its use.
 1174 — my compensation for completing this assignment is not contingent upon the
 1175 development or reporting of predetermined assignment results or assignment results
 1176 that favors the cause of the client, the attainment of a stipulated result, or the
 1177 occurrence of a subsequent event directly related to the intended use of this appraisal
 1178 review.
 1179 — my analyses, opinions, and conclusions were developed and this review report was
 1180 prepared in conformity with the *Uniform Standards of Professional Appraisal Practice*.
 1181 — I have (or have not) made a personal inspection of the subject of the work under
 1182 review. (If more than one person signs this certification, the certification must clearly
 1183 specify which individuals did and which individuals did not make a personal
 1184 inspection of the subject of the work under review.) (For reviews of a business or
 1185 intangible asset appraisal assignment, the inspection portion of the certification is not
 1186 applicable.)
 1187 — no one provided significant appraisal, appraisal review, or appraisal consulting
 1188 assistance to the person signing this certification. (If there are exceptions, the name of
 1189 each individual(s) providing appraisal, appraisal review, or appraisal consulting
 1190 assistance must be stated.)

1191 Comment: A signed certification is an integral part of the Appraisal Review Report. A
 1192 reviewer who signs any part of the appraisal review report, including a letter of transmittal,
 1193 must also sign the certification.

1194 Any reviewer who signs a certification accepts responsibility for all elements of the
 1195 certification, for the assignment results, and for the contents of the Appraisal Review Report.

1196 Appraisal review is distinctly different from the cosigning activity addressed in Standards
 1197 Rules 2-3, 5-3, 6-9, 8-3, and 10-3. To avoid confusion between these activities, a reviewer
 1198 performing an appraisal review must not sign the work under review unless he or she intends
 1199 to accept responsibility as a cosigner of that work.

1200 When a signing appraiser has relied on work done by appraisers and others who do not sign
 1201 the certification, the signing appraiser is responsible for the decision to rely on their work.
 1202 The signing appraiser is required to have a reasonable basis for believing that those
 1203 individuals performing the work are competent. The signing appraiser also must have no
 1204 reason to doubt that the work of those individuals is credible.

1205 The names of individuals providing significant appraisal, appraisal review, or appraisal
 1206 consulting assistance who do not sign a certification must be stated in the certification. It is

STANDARD 3

1207 not required that the description of their assistance be contained in the certification, but
1208 disclosure of their assistance is required in accordance with Standards Rule 3-5(g).

1209 **Standards Rule 3-7**

1210 **To the extent that it is both possible and appropriate, an oral Appraisal Review Report must address the**
1211 **substantive matters set forth in Standards Rule 3-5.**

1212 Comment: See the RECORD KEEPING RULE for corresponding requirements.

1213 **STANDARD 4: REAL PROPERTY APPRAISAL CONSULTING, DEVELOPMENT**

1214 **In developing a real property appraisal consulting assignment, an appraiser must identify the problem to**
 1215 **be solved, determine the scope of work necessary to solve the problem, and correctly complete the**
 1216 **research and analyses necessary to produce credible results.**

1217 Comment: Real property appraisal consulting assignments encompass a wide variety of
 1218 problems to be solved. However, the purpose of an assignment under this Standard is always
 1219 to develop, without advocacy, an analysis, recommendation, or opinion where at least one
 1220 opinion of value is a component of the analysis leading to the assignment results.

1221 In some assignments, the opinion of value may originate from a source other than the
 1222 consulting appraiser. In other assignments, the consulting appraiser may have to develop the
 1223 opinion of value as a step in the analyses leading to the assignment results.

1224 An opinion of value or an opinion as to the quality of another appraiser's work cannot be the
 1225 purpose of an appraisal consulting assignment. Developing an assignment for those purposes
 1226 is an appraisal or an appraisal review assignment, respectively. Misrepresenting the purpose
 1227 of an assignment performed under this Standard is a violation of the ETHICS RULE.

1228 The ETHICS and COMPETENCY RULES apply to the appraiser performing an appraisal
 1229 consulting assignment. Appraisers practicing under this Standard must perform the
 1230 assignment with impartiality, objectivity, independence, and without accommodation of
 1231 personal interests.

1232 Except when required by law, regulation, agreement, or choice, this appraisal consulting
 1233 STANDARD does not apply to services provided by an appraiser acting under the standards
 1234 of other professions or business activities. For example, when an appraiser who is also an
 1235 investment consultant provides a service that does not require an opinion of value, that
 1236 appraiser, acting as an investment consultant, is not performing an assignment addressed by
 1237 this Standard.

1238 **Standards Rule 4-1**

1239 **In performing a real property appraisal consulting assignment, an appraiser must:**

- 1240 **(a) be aware of, understand, and correctly employ those recognized methods and techniques that are**
 1241 **necessary to produce credible results;**
- 1242 **(b) not commit a substantial error of omission or commission that significantly affects the results of**
 1243 **an appraisal consulting assignment; and**
- 1244 **(c) not render appraisal consulting services in a careless or negligent manner, such as by making a**
 1245 **series of errors that, although individually might not significantly affect the results, in the**
 1246 **aggregate affect the credibility of those results.**

STANDARD 4

1247 **Standards Rule 4-2**

1248 **In developing real property appraisal consulting assignment results, an appraiser must:**

1249 **(a) identify the client and other intended users;**⁴²

1250 **(b) identify the intended use of the appraisal consulting assignment results;**⁴³

1251 **(c) identify:**

1252 **(i) the analysis, recommendation or opinion to be developed; and**

1253 **(ii) the type and definition of value developed in the appraisal(s) that is a necessary**
1254 **component of an analysis supporting the appraisal consulting assignment results;**

1255 Comment: If the applicable type and definition of value is market value, ascertain
1256 whether that value is to be the most probable price:

- 1257 • in terms of cash; or
- 1258 • in terms of financial arrangements equivalent to cash; or
- 1259 • in other precisely defined terms; and
- 1260 • if the opinion of value is to be based on non-market financing or financing with
- 1261 unusual conditions or incentives, the terms of such financing must be clearly
- 1262 identified and the appraiser's opinion of their contributions to or negative
- 1263 influence on value must be developed by analysis of relevant market data.

1264 **(d) identify the effective date of the appraisal consulting assignment results;**⁴⁴

1265 **(e) identify the physical, legal, and economic characteristics of the property, properties, property**
1266 **type(s), or market area that are relevant**⁴⁵ **to:**

1267 **(i) the analysis, recommendation or opinion to be developed in the appraisal consulting**
1268 **assignment; and**

1269 **(ii) an opinion of value that is a necessary component of an analysis supporting the**
1270 **appraisal consulting assignment results;**

1271 **(f) identify any extraordinary assumptions necessary in the appraisal consulting assignment and in**
1272 **developing the opinion(s) of value necessary to support the appraisal consulting assignment**
1273 **results;**

1274 Comment: An extraordinary assumption may be used in an assignment only if:

- 1275 • it is required to properly develop credible opinions and conclusions;
- 1276 • the appraiser has a reasonable basis for the extraordinary assumption;
- 1277 • use of the extraordinary assumption results in a credible analysis; and

⁴² See Statement on Appraisal Standards No. 9, *Identification of Intended Use and Intended Users*.

⁴³ See Statement on Appraisal Standards No. 9, *Identification of Intended Use and Intended Users*.

⁴⁴ See Statement on Appraisal Standards No. 3, *Retrospective Value Opinions* and Statement on Appraisal Standards No. 4, *Prospective Value Opinions*.

⁴⁵ See Advisory Opinion 2, *Inspection of Subject Property*, and Advisory Opinion 23, *Identifying the Relevant Characteristics of the Subject Property of a Real Property Appraisal Assignment*.

- 1278 • the appraiser complies with the disclosure requirements set forth in USPAP for
1279 extraordinary assumptions.

1280 **(g) identify any hypothetical conditions necessary in the appraisal consulting assignment and in**
1281 **developing the opinion(s) of value necessary to support the appraisal consulting assignment**
1282 **results; and**

1283 Comment: A hypothetical condition may be used in an assignment only if:

- 1284 • use of the hypothetical condition is clearly required for legal purposes, for purposes
1285 of reasonable analysis, or for purposes of comparison;
1286 • use of the hypothetical condition results in a credible analysis; and
1287 • the appraiser complies with the disclosure requirements set forth in USPAP for
1288 hypothetical conditions.

1289 **(h) determine the scope of work necessary to produce credible assignment results in accordance with**
1290 **the SCOPE OF WORK RULE⁴⁶, including:**

1291 **(i) the appraisal consulting methods and techniques to be employed, and**

1292 **(ii) the research and analysis required to:**

- 1293 • **ascertain the relevance and credibility of an opinion of value obtained from**
1294 **a source other than the appraiser performing the appraisal consulting**
1295 **assignment, or**
1296 • **develop an opinion of value that is a necessary component of an analysis**
1297 **supporting the appraisal consulting assignment results;**

1298 Comment: An appraiser must ensure that any opinion of value used in an appraisal consulting
1299 assignment was developed in compliance with STANDARD 1.

1300 If an opinion of value used in a real property appraisal consulting assignment is from a source
1301 other than the consulting appraiser, the assignment may include a review, prepared in
1302 compliance with STANDARD 3, of that appraisal. Alternatively, the appraiser may accept an
1303 appraisal from another source using an extraordinary assumption in the appraisal consulting
1304 assignment, provided that all conditions necessary to use such an extraordinary assumption
1305 are fulfilled.

1306 If the opinion of value is from an appraisal developed by the appraiser performing the real
1307 property appraisal consulting assignment, the appraiser must complete the steps set forth in
1308 STANDARD 1.

⁴⁶ See Advisory Opinion 28, *Scope of Work Decision, Performance, and Disclosure*, and Advisory Opinion 29, *An Acceptable Scope of Work*.

STANDARD 5

1309 STANDARD 5: REAL PROPERTY APPRAISAL CONSULTING, REPORTING

1310 **In reporting the results of a real property appraisal consulting assignment, an appraiser must**
1311 **communicate each analysis, opinion, and conclusion in a manner that is not misleading.**

1312 Comment: STANDARD 5 addresses the content and level of information required in a report
1313 that communicates the results of a real property appraisal consulting assignment.

1314 An appraiser must explain logically and convincingly the reasoning that leads to his or her
1315 conclusions. The flow of information must be orderly and progressive. The level of
1316 information necessary in the report is dependent on the intended use and intended users. The
1317 level of information detail in the report must be sufficient to enable the client and intended
1318 users of the report to understand the appraisal consulting assignment results and not be
1319 misled.

1320 STANDARD 5 does not dictate the form, format, or style of real property appraisal consulting
1321 reports. The form, format, and style of a report are functions of the needs of intended users
1322 and appraisers. The substantive content of a report determines its compliance.

1323 Standards Rule 5-1

1324 **Each written or oral real property appraisal consulting report must:**

- 1325 **(a) clearly and accurately set forth the appraisal consulting assignment results in a manner that will**
1326 **not be misleading;**
- 1327 **(b) contain sufficient information to enable the intended users of the appraisal consulting**
1328 **assignment results to understand the report properly; and**
- 1329 **(c) clearly and accurately disclose all assumptions, extraordinary assumptions, hypothetical**
1330 **conditions, and limiting conditions used in the assignment.**

1331 Comment: The content of a real property appraisal consulting report must be sufficiently
1332 comprehensive so that an intended user can understand the problem addressed and the
1333 analyses, and follow the reasoning through each step of the analytical process. It is essential
1334 that throughout the report the data, analyses, assumptions and conclusions are logical and
1335 adequately supported.

1336 Standards Rule 5-2

1337 **The content of each written real property appraisal consulting report must be consistent with the**
1338 **intended use of the appraisal consulting assignment results and, at a minimum:**

- 1339 **(a) state the identity of the client and any intended users, by name or type;⁴⁷**

1340 Comment: An appraiser must use care when identifying the client to ensure a clear
1341 understanding and to avoid violations of the Confidentiality section of the ETHICS RULE. In
1342 those rare instances where the client wishes to remain anonymous, an appraiser must still
1343 document the identity of the client in the workfile, but may omit the client's identity in the
1344 report.

⁴⁷ See Statement on Appraisal Standards No. 9, *Identification of Intended Use and Intended Users*.

1345 Intended users of the report might include parties such as lenders, employees of government
1346 agencies, partners of a client, and a client's attorney and accountant.

1347 **(b) state the analysis, recommendation or opinion developed;**

1348 **(c) state the intended use of the appraisal consulting assignment;⁴⁸**

1349 **(d) state information sufficient to identify the real property pertinent to the appraisal consulting
1350 assignment, and state the physical, legal, and economic characteristics of the property,
1351 properties, property types, or market area pertinent to the assignment;⁴⁹**

1352 **(e) state the effective date of the appraisal consulting assignment results, the date of appraisal
1353 pertinent to each opinion of value used in an analysis in support of the appraisal consulting
1354 results, and the date of the appraisal consulting report;⁵⁰**

1355 **(f) state the scope of work used to develop the assignment results;⁵¹**

1356 Comment: Because intended users' reliance on assignment results may be affected by the
1357 scope of work, the report must enable them to be properly informed and not misled. Sufficient
1358 information includes disclosure of research and analyses performed and might also include
1359 disclosure of research and analyses not performed.

1360 When any portion of the work involves significant real property appraisal or appraisal
1361 consulting assistance, the appraisal consultant must describe the extent of that assistance. The
1362 signing consulting appraiser must also state the name(s) of those providing significant real
1363 property appraisal or appraisal consulting assistance in the certification, in accordance with
1364 Standards Rule 5-3.⁵²

1365 **(g) summarize the information used in the appraisal consulting analyses, the appraisal consulting
1366 methods and techniques employed, and the reasoning that supports the analyses, opinions, and
1367 conclusions;**

1368 Comment: If the value opinion used in the appraisal consulting assignment was not performed
1369 by the consulting appraiser, the appraisal consulting report must include:

- 1370 • the information required in Standards Rule 3-5, or
- 1371 • a statement of the appraisal review results, and a reference to the appraisal review
1372 documentation retained in the appraisal consultant's appraisal consulting assignment
1373 workfile, or
- 1374 • a statement supporting the use of that appraisal as an extraordinary assumption in the
1375 appraisal consulting assignment.

1376 If an opinion of value was developed by the consulting appraiser, the appraisal consulting
1377 report must include the information required to comply with Standards Rule 2-2(a) or (b)(ii)
1378 through (x). Standards Rule 2-2(c)(ii) through (x) is also permitted if the client is the only
1379 intended user of the assignment results.

⁴⁸ See Statement on Appraisal Standards No. 9, *Identification of Intended Use and Intended Users*.

⁴⁹ See Advisory Opinion 2, *Inspection of Subject Property*.

⁵⁰ See Statement on Appraisal Standards No. 3, *Retrospective Value Opinions*, and Statement on Appraisal Standards No. 4, *Prospective Value Opinions*.

⁵¹ See Advisory Opinion 28, *Scope of Work Decision, Performance, and Disclosure*, and 29, *An Acceptable Scope of Work*.

⁵² See Advisory Opinion 31, *Assignments Involving More than One Appraiser*.

STANDARD 5

- 1380 (h) state the appraiser's appraisal consulting recommendations (if any), and conclusions or opinions;
- 1381 (i) clearly and conspicuously:
- 1382 • state all extraordinary assumptions and hypothetical conditions; and
 - 1383 • state that their use might have affected the assignment results; and
- 1384 (j) include a signed certification in accordance with Standards Rule 5-3.

1385 Standards Rule 5-3

1386 Each written real property appraisal consulting report must contain a signed certification that is similar
1387 in content to the following form:

1388 I certify that, to the best of my knowledge and belief:

- 1389 — the statements of fact contained in this report are true and correct.
- 1390 — the reported analyses, opinions, and conclusions are limited only by the reported
- 1391 assumptions and limiting conditions, and are my personal, impartial, and unbiased
- 1392 professional analyses, opinions, conclusions, and recommendations.
- 1393 — I have no (or the specified) present or prospective interest in the property that is the
- 1394 subject of this report, and I have no (or the specified) personal interest with respect to
- 1395 the parties involved.
- 1396 — I have performed no (or the specified) services, as an appraiser or in any other capacity,
- 1397 regarding the property that is the subject of this report within the three-year period
- 1398 immediately preceding acceptance of this assignment.
- 1399 — I have no bias with respect to any property that is the subject of this report or to the
- 1400 parties involved with this assignment.
- 1401 — my engagement in this assignment was not contingent upon developing or reporting
- 1402 predetermined results.
- 1403 — my compensation for completing this assignment is not contingent upon the
- 1404 development or reporting of a predetermined value or direction in value that favors
- 1405 the cause of the client, the amount of the value opinion, the attainment of a stipulated
- 1406 result, or the occurrence of a subsequent event directly related to the intended use of
- 1407 this appraisal consulting assignment.
- 1408 — my analyses, opinions, and conclusions were developed, and this report has been
- 1409 prepared, in conformity with the *Uniform Standards of Professional Appraisal Practice*.
- 1410 — I have (or have not) made a personal inspection of the property that is the subject of
- 1411 this report. (If more than one person signs this certification, the certification must
- 1412 clearly specify which individuals did and which individuals did not make a personal
- 1413 inspection of the property).⁵³
- 1414 — no one provided significant real property appraisal or appraisal consulting assistance
- 1415 to the person signing this certification. (If there are exceptions, the name of each
- 1416 individual providing significant real property appraisal or appraisal consulting
- 1417 assistance must be stated.)

1418 Comment: A signed certification is an integral part of the appraisal consulting report. An
1419 appraiser who signs any part of the appraisal consulting report, including a letter of
1420 transmittal, must also sign the certification.

1421 In an assignment that includes only assignment results developed by the real property
1422 appraiser(s), any appraiser(s) who signs a certification accepts full responsibility for all

⁵³ See Advisory Opinion 2, *Inspection of Subject Property*.

1423 elements of the certification, for the assignment results, and for the contents of the appraisal
1424 consulting report. In an assignment that includes personal property, business or intangible
1425 asset assignment results not developed by the real property appraiser(s), any real property
1426 appraiser(s) who signs a certification accepts full responsibility for the real property elements
1427 of the certification, for the real property assignment results, and for the real property contents
1428 of the appraisal consulting report.

1429 If the signing consulting appraiser(s) has relied on work done by appraisers and others who do
1430 not sign the certification, then the signing consulting appraiser(s) is responsible for the
1431 decision to rely on such work. The signing consulting appraiser is required to have a
1432 reasonable basis for believing that those individuals performing the work are competent. The
1433 signing appraiser(s) also must have no reason to doubt that the work of those individuals is
1434 credible.

1435 The names of individuals providing significant real property appraisal or appraisal consulting
1436 assistance who do not sign the certification must be stated in the certification. It is not
1437 required that the description of their assistance be contained in the certification, but disclosure
1438 of their assistance is required in accordance with Standards Rule 5-2(f).⁵⁴

1439 **Standards Rule 5-4**

1440 **To the extent that it is both possible and appropriate, an oral real property appraisal consulting report**
1441 **must address the substantive matters set forth in Standards Rule 5-2.**

1442 Comment: See the RECORD KEEPING RULE for corresponding requirements.

⁵⁴ See Advisory Opinion 31, *Assignments Involving More than One Appraiser*.

STANDARD 6

1443 STANDARD 6: MASS APPRAISAL, DEVELOPMENT AND REPORTING

1444 **In developing a mass appraisal, an appraiser must be aware of, understand, and correctly employ those**
1445 **recognized methods and techniques necessary to produce and communicate credible mass appraisals.**

1446 Comment: STANDARD 6 applies to all mass appraisals of real or personal property
1447 regardless of the purpose or use of such appraisals.⁵⁵ STANDARD 6 is directed toward the
1448 substantive aspects of developing and communicating credible analyses, opinions, and
1449 conclusions in the mass appraisal of properties. Mass appraisals can be prepared with or
1450 without computer assistance. The reporting and jurisdictional exceptions applicable to public
1451 mass appraisals prepared for ad valorem taxation do not apply to mass appraisals prepared for
1452 other purposes.

1453 A mass appraisal includes:

- 1454 1) identifying properties to be appraised;
- 1455 2) defining market area of consistent behavior that applies to properties;
- 1456 3) identifying characteristics (supply and demand) that affect the creation of value in
1457 that market area;
- 1458 4) developing a model structure that reflects the relationship among the characteristics
1459 affecting value in the market area;
- 1460 5) calibrating the model structure to determine the contribution of the individual
1461 characteristics affecting value;
- 1462 6) applying the conclusions reflected in the model to the characteristics of the
1463 property(ies) being appraised; and
- 1464 7) reviewing the mass appraisal results.

1465 The JURISDICTIONAL EXCEPTION RULE may apply to several sections of STANDARD
1466 6 because ad valorem tax administration is subject to various state, county, and municipal
1467 laws.

1468 Standards Rule 6-1

1469 **In developing a mass appraisal, an appraiser must:**

- 1470 **(a) be aware of, understand, and correctly employ those recognized methods and techniques**
1471 **necessary to produce a credible mass appraisal;**

1472 Comment: Mass appraisal provides for a systematic approach and uniform application of
1473 appraisal methods and techniques to obtain estimates of value that allow for statistical review
1474 and analysis of results.

1475 This requirement recognizes that the principle of change continues to affect the manner in
1476 which appraisers perform mass appraisals. Changes and developments in the real property and
1477 personal property fields have a substantial impact on the appraisal profession.

1478 To keep abreast of these changes and developments, the appraisal profession is constantly
1479 reviewing and revising appraisal methods and techniques and devising new methods and
1480 techniques to meet new circumstances. For this reason it is not sufficient for appraisers to
1481 simply maintain the skills and the knowledge they possess when they become appraisers.

⁵⁵ See Advisory Opinion 32, *Ad Valorem Property Tax Appraisal and Mass Appraisal Assignments*.

1482 Each appraiser must continuously improve his or her skills to remain proficient in mass
1483 appraisal.

1484 **(b) not commit a substantial error of omission or commission that significantly affects a mass**
1485 **appraisal; and**

1486 Comment: An appraiser must use sufficient care to avoid errors that would significantly affect
1487 his or her opinions and conclusions. Diligence is required to identify and analyze the factors,
1488 conditions, data, and other information that would have a significant effect on the credibility
1489 of the assignment results.

1490 **(c) not render a mass appraisal in a careless or negligent manner.**

1491 Comment: Perfection is impossible to attain, and competence does not require perfection.
1492 However, an appraiser must not render appraisal services in a careless or negligent manner.
1493 This Standards Rule requires an appraiser to use due diligence and due care.

1494 **Standards Rule 6-2**

1495 **In developing a mass appraisal, an appraiser must:**

1496 **(a) identify the client and other intended users;⁵⁶**

1497 **(b) identify the intended use of the appraisal;⁵⁷**

1498 Comment: An appraiser must not allow the intended use of an assignment or a client's objectives to
1499 cause the assignment results to be biased.

1500 **(c) identify the type and definition of value, and, if the value opinion to be developed is market**
1501 **value, ascertain whether the value is to be the most probable price:**

1502 **(i) in terms of cash; or**

1503 **(ii) in terms of financial arrangements equivalent to cash; or**

1504 **(iii) in such other terms as may be precisely defined; and**

1505 **(iv) if the opinion of value is based on non-market financing or financing with unusual**
1506 **conditions or incentives, the terms of such financing must be clearly identified and the**
1507 **appraiser's opinion of their contributions to or negative influence on value must be**
1508 **developed by analysis of relevant market data;**

1509 Comment: For certain types of appraisal assignments in which a legal definition of market
1510 value has been established and takes precedence, the JURISDICTIONAL EXCEPTION
1511 RULE may apply.

1512 **(d) identify the effective date of the appraisal;⁵⁸**

⁵⁶ See Statement on Appraisal Standards No. 9, *Identification of Intended Use and Intended Users*.

⁵⁷ See Statement on Appraisal Standards No. 9, *Identification of Intended Use and Intended Users*.

⁵⁸ See Statement on Appraisal Standards No. 3, *Prospective Value Opinions*, and Statement on Appraisal Standards No. 4, *Retrospective Value Opinions*.

STANDARD 6

- 1513 (e) **identify the characteristics of the properties that are relevant to the type and definition of value**
1514 **and intended use⁵⁹, including:**
- 1515 (i) **the group with which a property is identified according to similar market influence;**
- 1516 (ii) **the appropriate market area and time frame relative to the property being valued; and**
- 1517 (iii) **their location and physical, legal, and economic characteristics;**
- 1518 Comment: The properties must be identified in general terms, and each individual property in
1519 the universe must be identified, with the information on its identity stored or referenced in its
1520 property record.
- 1521 When appraising proposed improvements, an appraiser must examine and have available for
1522 future examination, plans, specifications, or other documentation sufficient to identify the
1523 extent and character of the proposed improvements.⁶⁰
- 1524 Ordinarily, proposed improvements are not appraised for ad valorem tax. Appraisers,
1525 however, are sometimes asked to provide opinions of value of proposed improvements so that
1526 developers can estimate future property tax burdens. Sometimes units in condominiums and
1527 planned unit developments are sold with an interest in un-built community property, the pro
1528 rata value of which, if any, must be considered in the analysis of sales data.
- 1529 (f) **identify the characteristics of the market that are relevant to the purpose and intended use of the**
1530 **mass appraisal including:**
- 1531 (i) **location of the market area;**
- 1532 (ii) **physical, legal, and economic attributes;**
- 1533 (iii) **time frame of market activity; and**
- 1534 (iv) **property interests reflected in the market;**
- 1535 (g) **in appraising real property or personal property:**
- 1536 (i) **identify the appropriate market area and time frame relative to the property being**
1537 **valued;**
- 1538 (ii) **when the subject is real property, identify and consider any personal property, trade**
1539 **fixtures, or intangibles that are not real property but are included in the appraisal;**
- 1540 (iii) **when the subject is personal property, identify and consider any real property or**
1541 **intangibles that are not personal property but are included in the appraisal;**
- 1542 (iv) **identify known easements, restrictions, encumbrances, leases, reservations, covenants,**
1543 **contracts, declarations, special assessments, ordinances, or other items of similar nature;**
1544 **and**

⁵⁹ See Advisory Opinion 23, *Identifying the Relevant Characteristics of the Subject Property of a Real Property Appraisal Assignment*, if applicable.

⁶⁰ See Advisory Opinion 17, *Appraisals of Real Property with Proposed Improvements*, if applicable.

1545 (v) **identify and analyze whether an appraised fractional interest, physical segment or**
 1546 **partial holding contributes pro rata to the value of the whole;**

1547 Comment: The above requirements do not obligate the appraiser to value the whole
 1548 when the subject of the appraisal is a fractional interest, physical segment, or a
 1549 partial holding. However, if the value of the whole is not identified, the appraisal
 1550 must clearly reflect that the value of the property being appraised cannot be used to
 1551 develop the value opinion of the whole by mathematical extension.

1552 (h) **analyze the relevant economic conditions at the time of the valuation, including market**
 1553 **acceptability of the property and supply, demand, scarcity, or rarity;**

1554 (i) **identify any extraordinary assumptions and any hypothetical conditions necessary in the**
 1555 **assignment; and**

1556 Comment: An extraordinary assumption may be used in an assignment only if:

- 1557 • it is required to properly develop credible opinions and conclusions;
- 1558 • the appraiser has a reasonable basis for the extraordinary assumption;
- 1559 • use of the extraordinary assumption results in a credible analysis; and
- 1560 • the appraiser complies with the disclosure requirements set forth in USPAP for
 1561 extraordinary assumptions.

1562 A hypothetical condition may be used in an assignment only if:

- 1563 • use of the hypothetical condition is clearly required for legal purposes, for purposes
 1564 of reasonable analysis, or for purposes of comparison;
- 1565 • use of the hypothetical condition results in a credible analysis; and
- 1566 • the appraiser complies with the disclosure requirements set forth in USPAP for
 1567 hypothetical conditions.

1568 (j) **determine the scope of work necessary to produce credible assignment results in accordance with**
 1569 **the SCOPE OF WORK RULE.⁶¹**

1570 Standards Rule 6-3

1571 **When necessary for credible assignment results, an appraiser must:**

1572 (a) **in appraising real property, identify and analyze the effect on use and value of the following**
 1573 **factors: existing land use regulations, reasonably probable modifications of such regulations,**
 1574 **economic supply and demand, the physical adaptability of the real estate, neighborhood trends,**
 1575 **and highest and best use of the real estate; and**

1576 Comment: This requirement sets forth a list of factors that affect use and value. In considering
 1577 neighborhood trends, an appraiser must avoid stereotyped or biased assumptions relating to
 1578 race, age, color, gender, or national origin or an assumption that race, ethnic, or religious
 1579 homogeneity is necessary to maximize value in a neighborhood. Further, an appraiser must
 1580 avoid making an unsupported assumption or premise about neighborhood decline, effective
 1581 age, and remaining life. In considering highest and best use, an appraiser must develop the
 1582 concept to the extent required for a proper solution to the appraisal problem.

⁶¹ See Advisory Opinion 28, *Scope of Work Decision, Performance, and Disclosure*, and Advisory Opinion 29, *An Acceptable Scope of Work*.

STANDARD 6

1583 **(b) in appraising personal property: identify and analyze the effects on use and value of industry**
1584 **trends, value-in-use, and trade level of personal property. Where applicable, analyze the current**
1585 **use and alternative uses to encompass what is profitable, legal, and physically possible, as**
1586 **relevant to the type and definition of value and intended use of the appraisal. Personal property**
1587 **has several measurable marketplaces; therefore, the appraiser must define and analyze the**
1588 **appropriate market consistent with the type and definition of value.**

1589 Comment: The appraiser must recognize that there are distinct levels of trade and each may
1590 generate its own data. For example, a property may have a different value at a wholesale level
1591 of trade, a retail level of trade, or under various auction conditions. Therefore, the appraiser
1592 must analyze the subject property within the correct market context.

1593 Standards Rule 6-4

1594 **In developing a mass appraisal, an appraiser must:**

1595 **(a) identify the appropriate procedures and market information required to perform the appraisal,**
1596 **including all physical, functional, and external market factors as they may affect the appraisal;**

1597 Comment: Such efforts customarily include the development of standardized data collection
1598 forms, procedures, and training materials that are used uniformly on the universe of properties
1599 under consideration.

1600 **(b) employ recognized techniques for specifying property valuation models; and**

1601 Comment: The formal development of a model in a statement or equation is called model
1602 specification. Mass appraisers must develop mathematical models that, with reasonable
1603 accuracy, represent the relationship between property value and supply and demand factors, as
1604 represented by quantitative and qualitative property characteristics. The models may be
1605 specified using the cost, sales comparison, or income approaches to value. The specification
1606 format may be tabular, mathematical, linear, nonlinear, or any other structure suitable for
1607 representing the observable property characteristics. Appropriate approaches must be used in
1608 appraising a class of properties. The concept of recognized techniques applies to both real and
1609 personal property valuation models.

1610 **(c) employ recognized techniques for calibrating mass appraisal models.**

1611 Comment: Calibration refers to the process of analyzing sets of property and market data to
1612 determine the specific parameters of a model. The table entries in a cost manual are examples
1613 of calibrated parameters, as well as the coefficients in a linear or nonlinear model. Models
1614 must be calibrated using recognized techniques, including, but not limited to, multiple linear
1615 regression, nonlinear regression, and adaptive estimation.

1616 Standards Rule 6-5

1617 **In developing a mass appraisal, when necessary for credible assignment results, an appraiser must:**

1618 **(a) collect, verify, and analyze such data as are necessary and appropriate to develop:**

1619 **(i) the cost new of the improvements;**

1620 **(ii) accrued depreciation;**

1621 **(iii) value of the land by sales of comparable properties;**

- 1622 (iv) value of the property by sales of comparable properties;
- 1623 (v) value by capitalization of income or potential earnings - i.e., rentals, expenses, interest
- 1624 rates, capitalization rates, and vacancy data;

1625 Comment: This Standards Rule requires appraisers engaged in mass appraisal to take

1626 reasonable steps to ensure that the quantity and quality of the factual data that are collected

1627 are sufficient to produce credible appraisals. For example, in real property, where applicable

1628 and feasible, systems for routinely collecting and maintaining ownership, geographic, sales,

1629 income and expense, cost, and property characteristics data must be established. Geographic

1630 data must be contained in as complete a set of cadastral maps as possible, compiled according

1631 to current standards of detail and accuracy. Sales data must be collected, confirmed, screened,

1632 adjusted, and filed according to current standards of practice. The sales file must contain, for

1633 each sale, property characteristics data that are contemporaneous with the date of sale.

1634 Property characteristics data must be appropriate and relevant to the mass appraisal models

1635 being used. The property characteristics data file must contain data contemporaneous with

1636 the date of appraisal including historical data on sales, where appropriate and available. The

1637 data collection program must incorporate a quality control program, including checks and

1638 audits of the data to ensure current and consistent records.

- 1639 (b) base estimates of capitalization rates and projections of future rental rates and/or potential
- 1640 earnings capacity, expenses, interest rates, and vacancy rates on reasonable and appropriate
- 1641 evidence;⁶²

1642 Comment: This requirement calls for an appraiser, in developing income and expense

1643 statements and cash flow projections, to weigh historical information and trends, current

1644 market factors affecting such trends, and reasonably anticipated events, such as competition

1645 from developments either planned or under construction.

- 1646 (c) identify and, as applicable, analyze terms and conditions of any available leases; and

- 1647 (d) identify the need for and extent of any physical inspection.⁶³

1648 **Standards Rule 6-6**

1649 **When necessary for credible assignment results in applying a calibrated mass appraisal model an**

1650 **appraiser must:**

- 1651 (a) value improved parcels by recognized methods or techniques based on the cost approach, the
- 1652 sales comparison approach, and income approach;
- 1653 (b) value sites by recognized methods or techniques; such techniques include but are not limited to
- 1654 the sales comparison approach, allocation method, abstraction method, capitalization of ground
- 1655 rent, and land residual technique;
- 1656 (c) when developing the value of a leased fee estate or a leasehold estate, analyze the effect on value,
- 1657 if any, of the terms and conditions of the lease;

1658 Comment: In ad valorem taxation the appraiser may be required by rules or law to appraise

1659 the property as if in fee simple, as though unencumbered by existing leases. In such cases,

⁶² See Statement on Appraisal Standards No. 2, *Discounted Cash Flow Analysis*.

⁶³ See Advisory Opinion 2, *Inspection of Subject Property*.

STANDARD 6

1660 market rent would be used in the appraisal, ignoring the effect of the individual, actual
1661 contract rents.

1662 **(d) analyze the effect on value, if any, of the assemblage of the various parcels, divided interests, or**
1663 **component parts of a property; the value of the whole must not be developed by adding together**
1664 **the individual values of the various parcels, divided interests, or component parts; and**

1665 Comment: When the value of the whole has been established and the appraiser seeks to value
1666 a part, the value of any such part must be tested by reference to appropriate market data and
1667 supported by an appropriate analysis of such data.

1668 **(e) when analyzing anticipated public or private improvements, located on or off the site, analyze**
1669 **the effect on value, if any, of such anticipated improvements to the extent they are reflected in**
1670 **market actions.**

1671 Standards Rule 6-7

1672 **In reconciling a mass appraisal an appraiser must:**

1673 **(a) reconcile the quality and quantity of data available and analyzed within the approaches used and**
1674 **the applicability and relevance of the approaches, methods and techniques used; and**

1675 **(b) employ recognized mass appraisal testing procedures and techniques to ensure that standards of**
1676 **accuracy are maintained.**

1677 Comment: It is implicit in mass appraisal that, even when properly specified and calibrated
1678 mass appraisal models are used, some individual value conclusions will not meet standards of
1679 reasonableness, consistency, and accuracy. However, appraisers engaged in mass appraisal
1680 have a professional responsibility to ensure that, on an overall basis, models produce value
1681 conclusions that meet attainable standards of accuracy. This responsibility requires appraisers
1682 to evaluate the performance of models, using techniques that may include but are not limited
1683 to, goodness-of-fit statistics, and model performance statistics such as appraisal-to-sale ratio
1684 studies, evaluation of hold-out samples, or analysis of residuals.

1685 Standards Rule 6-8

1686 **A written report of a mass appraisal must clearly communicate the elements, results, opinions, and value**
1687 **conclusions of the appraisal.**

1688 **Each written report of a mass appraisal must:**

1689 **(a) clearly and accurately set forth the appraisal in a manner that will not be misleading;**

1690 **(b) contain sufficient information to enable the intended users of the appraisal to understand the**
1691 **report properly;**

1692 Comment: Documentation for a mass appraisal for ad valorem taxation may be in the form of
1693 (1) property records, (2) sales ratios and other statistical studies, (3) appraisal manuals and
1694 documentation, (4) market studies, (5) model building documentation, (6) regulations, (7)
1695 statutes, and (8) other acceptable forms.

1696 **(c) clearly and accurately disclose all assumptions, extraordinary assumptions, hypothetical**
1697 **conditions, and limiting conditions used in the assignment;**

1698 Comment: The report must clearly and conspicuously:

- 1699 • state all extraordinary assumptions and hypothetical conditions; and
1700 • state that their use might have affected the assignment results.

1701 **(d) state the identity of the client and any intended users, by name or type;**⁶⁴

1702 **(e) state the intended use of the appraisal;**⁶⁵

1703 **(f) disclose any assumptions or limiting conditions that result in deviation from recognized methods
1704 and techniques or that affect analyses, opinions, and conclusions;**

1705 **(g) set forth the effective date of the appraisal and the date of the report;**

1706 Comment: In ad valorem taxation the effective date of the appraisal may be prescribed by law.
1707 If no effective date is prescribed by law, the effective date of the appraisal, if not stated, is
1708 presumed to be contemporaneous with the data and appraisal conclusions.

1709 The effective date of the appraisal establishes the context for the value opinion, while the date
1710 of the report indicates whether the perspective of the appraiser on the market and property as
1711 of the effective date of the appraisal was prospective, current, or retrospective.⁶⁶

1712 **(h) state the type and definition of value and cite the source of the definition;**

1713 Comment: Stating the type and definition of value also requires any comments needed to
1714 clearly indicate to intended users how the definition is being applied.⁶⁷

1715 When reporting an opinion of market value, state whether the opinion of value is:

- 1716 • In terms of cash or of financing terms equivalent to cash; or
1717 • Based on non-market financing with unusual conditions or incentives.

1718 When an opinion of market value is not in terms of cash or based on financing terms
1719 equivalent to cash, summarize the terms of such financing and explain their contributions to
1720 or negative influence on value.

1721 **(i) identify the properties appraised including the property rights;**

1722 Comment: The report documents the sources for location, describing and listing the property.
1723 When applicable, include references to legal descriptions, addresses, parcel identifiers,
1724 photos, and building sketches. In mass appraisal this information is often included in property
1725 records. When the property rights to be appraised are specified in a statute or court ruling, the
1726 law must be referenced.

⁶⁴ See Statement on Appraisal Standards No. 9, *Identification of the Intended Use and Intended Users*.

⁶⁵ See Statement on Appraisal Standards No. 9, *Identification of the Intended Use and Intended Users*.

⁶⁶ See Statement on Appraisal Standards No. 3, *Retrospective Value Opinions*, and Statement on Appraisal Standards No. 4, *Prospective Value Opinions*.

⁶⁷ See Statement on Appraisal Standards No. 6, *Reasonable Exposure Time in Real Property and Personal Property Opinions of Value*. See also Advisory Opinion 7, *Marketing Time Opinions*.

STANDARD 6

- 1727 (j) **describe the scope of work used to develop the appraisal;⁶⁸ exclusion of the sales comparison**
1728 **approach, cost approach, or income approach must be explained;**

1729 Comment: Because intended users' reliance on an appraisal may be affected by the scope of
1730 work, the report must enable them to be properly informed and not misled. Sufficient
1731 information includes disclosure of research and analyses performed and might also include
1732 disclosure of research and analyses not performed.

1733 When any portion of the work involves significant mass appraisal assistance, the appraiser
1734 must describe the extent of that assistance. The signing appraiser must also state the name(s)
1735 of those providing the significant mass appraisal assistance in the certification, in accordance
1736 with Standards Rule 6-9.⁶⁹

- 1737 (k) **describe and justify the model specification(s) considered, data requirements, and the model(s)**
1738 **chosen;**

1739 Comment: The appraiser must provide sufficient information to enable the client and
1740 intended users to have confidence that the process and procedures used conform to accepted
1741 methods and result in credible value conclusions. In the case of mass appraisal for ad valorem
1742 taxation, stability and accuracy are important to the credibility of value opinions. The report
1743 must include a discussion of the rationale for each model, the calibration techniques to be
1744 used, and the performance measures to be used.

- 1745 (l) **describe the procedure for collecting, validating, and reporting data;**

1746 Comment: The report must describe the sources of data and the data collection and validation
1747 processes. Reference to detailed data collection manuals must be made, as appropriate,
1748 including where they may be found for inspection.

- 1749 (m) **describe calibration methods considered and chosen, including the mathematical form of the**
1750 **final model(s); describe how value conclusions were reviewed; and, if necessary, describe the**
1751 **availability of individual value conclusions;**

- 1752 (n) **when an opinion of highest and best use, or the appropriate market or market level was**
1753 **developed, discuss how that opinion was determined;**

1754 Comment: The mass appraisal report must reference case law, statute, or public policy that
1755 describes highest and best use requirements. When actual use is the requirement, the report
1756 must discuss how use-value opinions were developed. The appraiser's reasoning in support of
1757 the highest and best use opinion must be provided in the depth and detail required by its
1758 significance to the appraisal.

- 1759 (o) **identify the appraisal performance tests used and set forth the performance measures attained;**

- 1760 (p) **describe the reconciliation performed, in accordance with Standards Rule 6-7; and**

- 1761 (q) **include a signed certification in accordance with Standards Rule 6-9.**

⁶⁸ See Advisory Opinion 28, *Scope of Work Decision, Performance, and Disclosure* and Advisory Opinion 29, *An Acceptable Scope of Work*.

⁶⁹ See Advisory Opinion 31, *Assignments Involving More than One Appraiser*.

1762 Standards Rule 6-9

1763 Each written mass appraisal report must contain a signed certification that is similar in content to the
 1764 following form:

1765 I certify that, to the best of my knowledge and belief:

- 1766 — the statements of fact contained in this report are true and correct.
 1767 — the reported analyses, opinions, and conclusions are limited only by the reported
 1768 assumptions and limiting conditions, and are my personal, impartial, and unbiased
 1769 professional analyses, opinions, and conclusions.
 1770 — I have no (or the specified) present or prospective interest in the property that is the
 1771 subject of this report, and I have no (or the specified) personal interest with respect to
 1772 the parties involved.
 1773 — I have performed no (or the specified) services, as an appraiser or in any other capacity,
 1774 regarding the property that is the subject of this report within the three-year period
 1775 immediately preceding acceptance of this assignment.
 1776 — I have no bias with respect to any property that is the subject of this report or to the
 1777 parties involved with this assignment.
 1778 — my engagement in this assignment was not contingent upon developing or reporting
 1779 predetermined results.
 1780 — my compensation for completing this assignment is not contingent upon the reporting
 1781 of a predetermined value or direction in value that favors the cause of the client, the
 1782 amount of the value opinion, the attainment of a stipulated result, or the occurrence of
 1783 a subsequent event directly related to the intended use of this appraisal.
 1784 — my analyses, opinions, and conclusions were developed, and this report has been
 1785 prepared, in conformity with the *Uniform Standards of Professional Appraisal Practice*.
 1786 — I have (or have not) made a personal inspection of the properties that are the subject
 1787 of this report. (If more than one person signs the report, this certification must clearly
 1788 specify which individuals did and which individuals did not make a personal
 1789 inspection of the appraised property.)⁷⁰
 1790 — no one provided significant mass appraisal assistance to the person signing this
 1791 certification. (If there are exceptions, the name of each individual providing
 1792 significant mass appraisal assistance must be stated.)

1793 Comment: The above certification is not intended to disturb an elected or appointed assessor's
 1794 work plans or oaths of office. A signed certification is an integral part of the appraisal report.
 1795 An appraiser, who signs any part of the mass appraisal report, including a letter of transmittal,
 1796 must also sign this certification.

1797 In an assignment that includes only assignment results developed by the real property
 1798 appraiser(s), any appraiser(s) who signs a certification accepts full responsibility for all
 1799 elements of the certification, for the assignment results, and for the contents of the appraisal
 1800 report. In an assignment that includes personal property assignment results not developed by
 1801 the real property appraiser(s), any real property appraiser(s) who signs a certification accepts
 1802 full responsibility for the real property elements of the certification, for the real property
 1803 assignment results, and for the real property contents of the appraisal report.

1804 In an assignment that includes only assignment results developed by the personal property
 1805 appraiser(s), any appraiser(s) who signs a certification accepts full responsibility for all
 1806 elements of the certification, for the assignment results, and for the contents of the appraisal
 1807 report. In an assignment that includes real property assignment results not developed by the

⁷⁰ See Advisory Opinion 2, *Inspection of Subject Property*.

STANDARD 6

1808 personal property appraiser(s), any personal property appraiser(s) who signs a certification
1809 accepts full responsibility for the personal property elements of the certification, for the
1810 personal property assignment results, and for the personal property contents of the appraisal
1811 report.

1812 When a signing appraiser(s) has relied on work done by appraisers and others who do not sign
1813 the certification, the signing appraiser is responsible for the decision to rely on their work.
1814 The signing appraiser(s) is required to have a reasonable basis for believing that those
1815 individuals performing the work are competent. The signing appraiser(s) also must have no
1816 reason to doubt that the work of those individuals is credible.

1817 The names of individuals providing significant mass appraisal assistance who do not sign a
1818 certification must be stated in the certification. It is not required that the description of their
1819 assistance be contained in the certification, but disclosure of their assistance is required in
1820 accordance with Standards Rule 6-8(j).⁷¹

⁷¹ See Advisory Opinion 31, *Assignments Involving More than One Appraiser*.

1821 **STANDARD 7: PERSONAL PROPERTY APPRAISAL, DEVELOPMENT**

1822 **In developing a personal property appraisal, an appraiser must identify the problem to be solved,**
 1823 **determine the scope of work necessary to solve the problem, and correctly complete research and**
 1824 **analyses necessary to produce a credible appraisal.**

1825 Comment: STANDARD 7 is directed toward the substantive aspects of developing a credible
 1826 appraisal of personal property. The requirements set forth in STANDARD 7 follow the
 1827 appraisal development process in the order of topics addressed and can be used by appraisers
 1828 and the users of appraisal services as a convenient checklist.

1829 **Standards Rule 7-1**

1830 **In developing a personal property appraisal, an appraiser must:**

1831 **(a) be aware of, understand, and correctly employ those recognized methods and techniques that are**
 1832 **necessary to produce a credible appraisal;**

1833 Comment: This Standards Rule recognizes that change continues to affect the manner in
 1834 which appraisers perform appraisal services. Changes and developments in personal property
 1835 practice have a substantial impact on the appraisal profession. Important changes in the cost
 1836 and manner of acquiring, producing, and marketing personal property and changes in the legal
 1837 framework in which appraisers perform their assignments result in the need for corresponding
 1838 changes in personal property appraisal theory and practice. Social change has also had an
 1839 effect on appraisal theory and practice. The appraisal profession responds to changing
 1840 circumstances with revised and new appraisal methods and techniques. Therefore, it is not
 1841 sufficient for appraisers to maintain the skills and the knowledge they possess when they
 1842 become appraisers. Each appraiser must improve and update his or her skills and knowledge
 1843 to remain proficient in the appraisal of personal property.

1844 **(b) not commit a substantial error of omission or commission that significantly affects an**
 1845 **appraisal; and**

1846 Comment: An appraiser must use sufficient care to avoid errors that would significantly affect
 1847 his or her opinions and conclusions. Diligence is required to identify and analyze the factors,
 1848 conditions, data, and other information that would have a significant effect on the credibility
 1849 of the assignment results.

1850 **(c) not render appraisal services in a careless or negligent manner, such as by making a series of**
 1851 **errors that, although individually might not significantly affect the results of an appraisal, in the**
 1852 **aggregate affect the credibility of those results.**

1853 Comment: Perfection is impossible to attain, and competence does not require perfection.
 1854 However, an appraiser must not render appraisal services in a careless or negligent manner.
 1855 This Standards Rule requires an appraiser to use due diligence and care.

1856 **Standards Rule 7-2**

1857 **In developing a personal property appraisal, an appraiser must:**

1858 **(a) identify the client and other intended users;**

1859 **(b) identify the intended use of the appraiser's opinions and conclusions;**

STANDARD 7

1860 Comment: An appraiser must not allow the intended use of an assignment or a client's
1861 objectives to cause the assignment results to be biased.

1862 **(c) identify the type and definition of value. If the value opinion to be developed is market value,**
1863 **ascertain whether the value is to be the most probable price:**

1864 **(i) in terms of cash; or**

1865 **(ii) in terms of financial arrangements equivalent to cash; or**

1866 **(iii) in other precisely defined terms; and**

1867 **(iv) if the opinion of value is to be based on non-market financing or financing with unusual**
1868 **conditions or incentives, the terms of such financing must be clearly identified and the**
1869 **appraiser's opinion of their contributions to or negative influence on value must be**
1870 **developed by analysis of relevant market data;**

1871 Comment: When exposure time is a component of the definition for the value
1872 opinion being developed, the appraiser must also develop an opinion of reasonable
1873 exposure time linked to that value opinion.

1874 **(d) identify the effective date of the appraiser's opinions and conclusions;**

1875 **(e) identify the characteristics of the property that are relevant to the type and definition of value**
1876 **and intended use of the appraisal, including:**

1877 **(i) sufficient characteristics to establish the identity of the item including the method of**
1878 **identification;**

1879 **(ii) sufficient characteristics to establish the relative quality of the item (and its component**
1880 **parts, where applicable) within its type;**

1881 **(iii) all other physical and economic attributes with a material effect on value;**

1882 Comment: Some examples of physical and economic characteristics include
1883 condition, style, size, quality, manufacturer, author, materials, origin, age,
1884 provenance, alterations, restorations, and obsolescence. The type of property, the
1885 type and definition of value, and intended use of the appraisal determine which
1886 characteristics have a material effect on value.

1887 **(iv) the ownership interest to be valued;**

1888 **(v) any known restrictions, encumbrances, leases, covenants, contracts, declarations, special**
1889 **assessments, ordinances, or other items of a similar nature if relevant to the assignment;**
1890 **and**

1891 **(vi) any real property or intangible items that are not personal property but which are**
1892 **included in the appraisal;**

1893 Comment on (i)–(vi): The information used by an appraiser to identify the property
1894 characteristics must be from sources the appraiser reasonably believes are reliable.

1895 An appraiser may use any combination of a property inspection and documents or
1896 other resources to identify the relevant characteristics of the subject property.

1897 When appraising proposed modifications, an appraiser must examine and have
1898 available for future examination, documentation sufficient to identify the extent and
1899 character of the proposed modifications.

1900 An appraiser may not be required to value the whole when the subject of the
1901 appraisal is a fractional interest, a physical segment, or a partial holding.

1902 **(f) identify any extraordinary assumptions necessary in the assignment;**

1903 Comment: An extraordinary assumption may be used in an assignment only if:

- 1904 • it is required to properly develop credible opinions and conclusions;
- 1905 • the appraiser has a reasonable basis for the extraordinary assumption;
- 1906 • use of the extraordinary assumption results in a credible analysis; and
- 1907 • the appraiser complies with the disclosure requirements set forth in USPAP for
1908 extraordinary assumptions.

1909 **(g) identify any hypothetical conditions necessary in the assignment; and**

1910 Comment: A hypothetical condition may be used in an assignment only if:

- 1911 • use of the hypothetical condition is clearly required for legal purposes, for purposes
1912 of reasonable analysis, or for purposes of comparison;
- 1913 • use of the hypothetical condition results in a credible analysis; and
- 1914 • the appraiser complies with the disclosure requirements set forth in USPAP for
1915 hypothetical conditions.

1916 **(h) determine the scope of work necessary to produce credible assignment results in accordance with
1917 the SCOPE OF WORK RULE.**

1918 **Standard Rule 7-3**

1919 **In developing a personal property appraisal, when necessary for credible assignment results, an
1920 appraiser must:**

1921 **(a) analyze the property's current use and alternative uses as relevant to the type and definition of
1922 value and intended use of the appraisal;**

1923 Comment: In the context of personal property, value can be a function of the choice of the
1924 appropriate market or, in some cases, market level for the type of item, the type and definition
1925 of value, and the intended use of the appraisal.

1926 The appraiser must consider the various uses of the property when viable alternative uses
1927 exist and when those alternative uses may result in a different value.

1928 **(b) define and analyze the appropriate market consistent with the type and definition of value; and**

1929 Comment: The appraiser must recognize that there are distinct levels of trade (measurable
1930 marketplaces) and each may generate its own data. For example, a property may have a
1931 different value at a wholesale level of trade, retail level of trade, or under various auction
1932 conditions. Therefore, the appraiser must analyze the subject property within the correct
1933 market context.

1934 **(c) analyze the relevant economic conditions that exist on the effective date of the valuation,
1935 including market acceptability of the property and supply, demand, scarcity or rarity.**

1936 **Standards Rule 7-4**

1937 **In developing a personal property appraisal, an appraiser must collect, verify, and analyze all
1938 information necessary for credible assignment results.**

STANDARD 7

- 1939 (a) When a sales comparison approach is necessary for credible assignment results, an appraiser
1940 must analyze such comparable sales data as are available to indicate a value conclusion.
- 1941 (b) When a cost approach is necessary for credible assignment results, an appraiser must:
- 1942 (i) analyze such comparable cost data as are available to estimate the cost new of the
1943 property; and
- 1944 (ii) analyze such comparable data as are available to estimate the difference between cost
1945 new and the present worth of the property (accrued depreciation).
- 1946 (c) When an income approach is necessary for credible assignment results, an appraiser must:
- 1947 (i) analyze such comparable data as are available to estimate the market income of the
1948 property;
- 1949 (ii) analyze such comparable operating expense data as are available to estimate the
1950 operating expenses of the property;
- 1951 (iii) analyze such comparable data as are available to estimate rates of capitalization and/or
1952 rates of discount; and
- 1953 (iv) base projections of future income and expenses on reasonably clear and appropriate
1954 evidence.
- 1955 Comment: An appraiser must, in developing income and expense statements and
1956 cash flow projections, weigh historical information and trends, current supply and
1957 demand factors affecting such trends, and competition.
- 1958 (d) When developing an opinion of the value of a lease, leased, or encumbered property, an
1959 appraiser must analyze the effect on value, if any, of the terms and conditions of the lease(s) or
1960 encumbrances.
- 1961 (e) When appraising multiple objects, the appraiser must consider the significance of the value of
1962 the individual assets to the assignment results. Those objects which are more significant to the
1963 assignment results should be the focus of the analysis and analyzed in appropriate detail.
- 1964 Comment: A group of objects may have a mix of high and low value items. Those objects
1965 that are more significant to the assignment results should be subject to a greater and
1966 appropriate depth of analysis.
- 1967 (f) When analyzing the assemblage of the various component parts of a property, an appraiser must
1968 analyze the effect on value, if any, of the assemblage. An appraiser must refrain from valuing the
1969 whole solely by adding together the individual values of the various component parts.
- 1970 Comment: Although the value of the whole may be equal to the sum of the separate parts, it
1971 also may be greater than or less than the sum of such parts. Therefore, the value of the whole
1972 must be tested by reference to appropriate data and supported by an appropriate analysis of
1973 such data.
- 1974 A similar procedure must be followed when the value of the whole has been established and
1975 the appraiser seeks to value a part. The value of any such part must be tested by reference to
1976 appropriate data and supported by an appropriate analysis of such data.
- 1977 (g) When analyzing anticipated modifications to the subject property, an appraiser must analyze the
1978 effect on value, if any, of such modifications to the extent they are reflected in market actions.
- 1979 (h) When real property or intangible items are included in the appraisal, the appraiser must analyze
1980 the effect on value of such non-personal property items.

1981 Comment: When the scope of work includes an appraisal of real property or intangible items,
 1982 competency in real property appraisal (see STANDARD 1) or business appraisal (see
 1983 STANDARD 9) is required. In addition, competency in other types of personal property
 1984 outside of the appraiser's specialty area may be necessary (see STANDARD 7 and the
 1985 COMPETENCY RULE).

1986 **Standards Rule 7-5**

1987 **When developing an opinion of market value, an appraiser must, if such information is available to the**
 1988 **appraiser in the normal course of business:⁷²**

- 1989 **(a) analyze all agreements of sale, validated offers or third-party offers to sell, options, and listings**
 1990 **of the subject property current as of the effective date of the appraisal if warranted by the**
 1991 **intended use of the appraisal; and**
- 1992 **(b) analyze all prior sales of the subject property that occurred within a reasonable and applicable**
 1993 **time period if relevant given the intended use of the appraisal and property type.**

1994 Comment: The data needed for the required analyses in Standards Rule 7-5(a) and 7-5(b)
 1995 may not be available or relevant in all assignments. See the Comments to Standards Rules 8-
 1996 2(a)(viii), 8-2(b)(viii), and 8-2(c)(viii) for corresponding reporting requirements.

1997 **Standards Rule 7-6**

1998 **In developing a personal property appraisal, an appraiser must:**

- 1999 **(a) reconcile the quality and quantity of data available and analyzed within the approach or**
 2000 **approaches used; and**
- 2001 **(b) reconcile the applicability and relevance of the approach or approaches, methods and techniques**
 2002 **used to arrive at the value conclusion(s).**

⁷² See Advisory Opinion 24, *Normal Course of Business*.

STANDARD 8

2003 STANDARD 8: PERSONAL PROPERTY APPRAISAL, REPORTING

2004 **In reporting the results of a personal property appraisal, an appraiser must communicate each analysis,**
2005 **opinion, and conclusion in a manner that is not misleading.**

2006 Comment: STANDARD 8 addresses the content and level of information required in a report
2007 that communicates the results of a personal property appraisal.

2008 STANDARD 8 does not dictate the form, format, or style of personal property appraisal
2009 reports, which are functions of the needs of intended users and appraisers. The substantive
2010 content of a report determines its compliance.

2011 Standards Rule 8-1

2012 **Each written or oral personal property appraisal report must:**

2013 (a) **clearly and accurately set forth the appraisal in a manner that will not be misleading;**

2014 (b) **contain sufficient information to enable the intended users of the appraisal to understand the**
2015 **report properly; and**

2016 (c) **clearly and accurately disclose all assumptions, extraordinary assumptions, hypothetical**
2017 **conditions, and limiting conditions used in the assignment.**

2018 Standards Rule 8-2

2019 **Each written personal property appraisal report must be prepared under one of the following three**
2020 **options and prominently state which option is used: Self-Contained Appraisal Report, Summary**
2021 **Appraisal Report, or Restricted Use Appraisal Report.**⁷³

2022 Comment: When the intended users include parties other than the client, either a Self-
2023 Contained Appraisal Report or a Summary Appraisal Report must be provided. When the
2024 intended users do not include parties other than the client, a Restricted Use Appraisal Report
2025 may be provided.

2026 The essential difference among these three options is in the content and level of information
2027 provided. The appropriate reporting option and the level of information necessary in the
2028 report are dependent on the intended use and intended users.

2029 An appraiser must use care when characterizing the type of report and level of information
2030 communicated upon completion of an assignment. An appraiser may use any other label in
2031 addition to, but not in place of, the label set forth in this Standard for the type of report
2032 provided.

2033 The report content and level of information requirements set forth in this Standard are
2034 minimums for each type of report. An appraiser must supplement a report form, when
2035 necessary, to ensure that any intended user of the appraisal is not misled and that the report
2036 complies with the applicable content requirements set forth in this Standards Rule.

⁷³ See Advisory Opinion 11, *Content of the Appraisal Report Options of Standards Rules 2-2 and 8-2*, and Advisory Opinion 12, *Use of the Appraisal Report Options of Standards Rules 2-2 and 8-2*.

2037 A party receiving a copy of a Self-Contained Appraisal Report, Summary Appraisal Report, or
 2038 Restricted Use Appraisal Report in order to satisfy disclosure requirements does not become
 2039 an intended user of the appraisal unless the appraiser identifies such party as an intended user
 2040 as part of the assignment.

2041 **(a) The content of a Self-Contained Appraisal Report must be consistent with the intended use of the**
 2042 **appraisal and, at a minimum:**

2043 **(i) state the identity of the client and any intended users, by name or type;⁷⁴**

2044 Comment: An appraiser must use care when identifying the client to ensure a clear
 2045 understanding and to avoid violations of the Confidentiality section of the ETHICS
 2046 RULE. In those rare instances where the client wishes to remain anonymous, an
 2047 appraiser must still document the identity of the client in the workfile but may omit
 2048 the client's identity in the report.

2049 **(ii) state the intended use of the appraisal;⁷⁵**

2050 **(iii) describe information sufficient to identify the property involved in the appraisal,**
 2051 **including the physical and economic property characteristics relevant to the assignment;**

2052 **(iv) state the property interest appraised;**

2053 **(v) state the type and definition of value and cite the source of the definition;**

2054 Comment: Stating the definition of value also requires any comments needed to
 2055 clearly indicate to the intended users how the definition is being applied.

2056 When reporting an opinion of market value, state whether the opinion of value is:

- 2057 • in terms of cash or of financing terms equivalent to cash, or
- 2058 • based on non-market financing or financing with unusual conditions or
- 2059 incentives.

2060 When an opinion of market value is not in terms of cash or based on financing terms
 2061 equivalent to cash, summarize the terms of such financing and explain their
 2062 contributions to or negative influence on value.

2063 When an opinion of reasonable exposure time has been developed in compliance
 2064 with Standards Rule 7-2(c), the opinion must be stated in the report.⁷⁶

2065 **(vi) state the effective date of the appraisal and the date of the report;⁷⁷**

2066 Comment: The effective date of the appraisal establishes the context for the value
 2067 opinion, while the date of the report indicates whether the perspective of the

⁷⁴ See Statement on Appraisal Standards No. 9, *Identification of Intended Use and Intended Users*.

⁷⁵ See Statement on Appraisal Standards No. 9, *Identification of Intended Use and Intended Users*.

⁷⁶ See Statement on Appraisal Standards No. 6, *Reasonable Exposure Time in Real Property and Personal Property Opinions of Value*. See also Advisory Opinion 7, *Marketing Time Opinions*.

⁷⁷ See Statement on Appraisal Standards No. 3, *Retrospective Value Opinions*, and Statement on Appraisal Standards No. 4, *Prospective Value Opinions*

STANDARD 8

2068 appraiser on the market and property as of the effective date of the appraisal was
2069 prospective, current, or retrospective.

2070 **(vii) describe the scope of work used to develop the appraisal;**⁷⁸

2071 Comment: Because intended users' reliance on an appraisal may be affected by the
2072 scope of work, the report must enable them to be properly informed and not misled.
2073 Sufficient information includes disclosure of research and analyses performed and
2074 might also include disclosure of research and analyses not performed.

2075 When any portion of the work involves significant personal property appraisal
2076 assistance, the appraiser must describe the extent of that assistance. The signing
2077 appraiser must also state the name(s) of those providing the significant personal
2078 property appraisal assistance in the certification, in accordance with Standards Rule
2079 8-3.⁷⁹

2080 **(viii) describe the information analyzed, the appraisal methods and techniques employed, and**
2081 **the reasoning that supports the analyses, opinions, and conclusions; exclusion of the**
2082 **sales comparison approach, cost approach, or income approach must be explained;**⁸⁰

2083 Comment: A Self-Contained Appraisal Report must include sufficient information to
2084 indicate that the appraiser complied with the requirements of STANDARD 7. The
2085 amount of detail required will vary with the significance of the information to the
2086 appraisal and with the significance of a particular object or group of objects to the
2087 overall assignment results.

2088 The appraiser must provide sufficient information to enable the client and intended
2089 users to understand the rationale for the opinions and conclusions, including
2090 reconciliation of the data and approaches, in accordance with Standards Rule 7-6.

2091 When reporting an opinion of market value, a summary of the results of analyzing
2092 the subject sales, offers, options, and listings in accordance with Standards Rule 7-5
2093 is required. If such information was unobtainable, a statement on the efforts
2094 undertaken by the appraiser to obtain the information is required. If such information
2095 is irrelevant, a statement acknowledging the existence of the information and citing
2096 its lack of relevance is required.

2097 **(ix) state, as appropriate to the class of personal property involved, the use of the property**
2098 **existing as of the date of value and the use of the property reflected in the appraisal;**
2099 **and, when an opinion of the appropriate market or market level was developed by the**
2100 **appraiser, describe the support and rationale for that opinion;**

2101 Comment: In the context of personal property, value can be a function of the current
2102 and alternative use of the subject property, the choice of the appropriate market or
2103 market level for the type of item, the type and definition of value, and intended use
2104 of the report.

2105 **(x) clearly and conspicuously:**

⁷⁸ See Advisory Opinion 28, *Scope of Work Decision, Performance, and Disclosure* and Advisory Opinion 29, *An Acceptable Scope of Work*.

⁷⁹ See Advisory Opinion 31, *Assignments Involving More than One Appraiser*.

⁸⁰ See Advisory Opinion 2, *Inspection of Subject Property*.

- 2106 • **state all extraordinary assumptions and hypothetical conditions; and**
 2107 • **state that their use might have affected the assignment results; and**
- 2108 (xi) **include a signed certification in accordance with Standards Rule 8-3.**
- 2109 (b) **The content of a Summary Appraisal Report must be consistent with the intended use of the**
 2110 **appraisal and, at a minimum:**
- 2111 Comment: The essential difference between the Self-Contained Appraisal Report and the
 2112 Summary Appraisal Report is the level of detail of presentation.
- 2113 (i) **state the identity of the client and any intended users, by name or type;⁸¹**
- 2114 Comment: An appraiser must use care when identifying the client to ensure a clear
 2115 understanding and to avoid violations of the Confidentiality section of the ETHICS
 2116 RULE. In those rare instances where the client wishes to remain anonymous, an
 2117 appraiser must still document the identity of the client in the workfile but may omit
 2118 the client's identity in the report.
- 2119 (ii) **state the intended use of the appraisal;⁸²**
- 2120 (iii) **summarize information sufficient to identify the property involved in the appraisal,**
 2121 **including the physical and economic property characteristics relevant to the assignment;**
- 2122 (iv) **state the property interest appraised;**
- 2123 (v) **state the type and definition of value and cite the source of the definition;**
- 2124 Comment: Stating the definition of value also requires any comments needed to
 2125 clearly indicate to the intended users how the definition is being applied.
- 2126 When reporting an opinion of market value, state whether the opinion of value is:
- 2127 • in terms of cash or of financing terms equivalent to cash, or
 2128 • based on non-market financing or financing with unusual conditions or
 2129 incentives.
- 2130 When an opinion of market value is not in terms of cash or based on financing terms
 2131 equivalent to cash, summarize the terms of such financing and explain their
 2132 contributions to or negative influence on value.
- 2133 When an opinion of reasonable exposure time has been developed in compliance
 2134 with Standards Rule 7-2(c), the opinion must be stated in the report.⁸³
- 2135 (vi) **state the effective date of the appraisal and the date of the report;⁸⁴**

⁸¹ See Statement on Appraisal Standards No. 9, *Identification of Intended Use and Intended Users*.

⁸² See Statement on Appraisal Standards No. 9, *Identification of Intended Use and Intended Users*.

⁸³ See Statement on Appraisal Standards No. 6, *Reasonable Exposure Time in Real Property and Personal Property Opinions of Value*. See also Advisory Opinion 7, *Marketing Time Opinions*.

⁸⁴ See Statement on Appraisal Standards No. 3, *Retrospective Value Opinions*, and Statement on Appraisal Standards No. 4, *Prospective Value Opinions*.

STANDARD 8

2136 Comment: The effective date of the appraisal establishes the context for the value
2137 opinion, while the date of the report indicates whether the perspective of the
2138 appraiser on the market and property as of the effective date of the appraisal was
2139 prospective, current, or retrospective.

2140 **(vii) summarize the scope of work used to develop the appraisal;**⁸⁵

2141 Comment: Because intended users' reliance on an appraisal may be affected by the
2142 scope of work, the report must enable them to be properly informed and not misled.
2143 Sufficient information includes disclosure of research and analyses performed and
2144 might also include disclosure of research and analyses not performed.

2145 When any portion of the work involves significant personal property appraisal
2146 assistance, the appraiser must summarize the extent of that assistance. The signing
2147 appraiser must also state the name(s) of those providing the significant personal
2148 property appraisal assistance in the certification, in accordance with Standards Rule
2149 8-3.⁸⁶

2150 **(viii) summarize the information analyzed, the appraisal methods and techniques employed,
2151 and the reasoning that supports the analyses, opinions, and conclusions; exclusion of the
2152 sales comparison approach, cost approach, or income approach must be explained;**⁸⁷

2153 Comment: A Summary Appraisal Report must include sufficient information to
2154 indicate that the appraiser complied with the requirements of STANDARD 7. The
2155 amount of detail required will vary with the significance of the information to the
2156 appraisal and with the significance of a particular object or group of objects to the
2157 overall assignment results.

2158 The appraiser must provide sufficient information to enable the client and intended
2159 users to understand the rationale for the opinion and conclusions, including
2160 reconciliation of the data and approaches, in accordance with Standards Rule 7-6.

2161 When reporting an opinion of market value, a summary of the results of the analysis
2162 of the subject sales, offers, options, and listings in accordance with Standards Rule 7-
2163 5 is necessary. If such information was unobtainable, a statement on the efforts
2164 undertaken by the appraiser to obtain the information is required. If such information
2165 is irrelevant, a statement acknowledging the existence of the information and citing
2166 its lack of relevance is required.

2167 **(ix) state, as appropriate to the class of personal property involved, the use of the property
2168 existing as of the date of value and the use of the property reflected in the appraisal;
2169 and, when an opinion of the appropriate market or market level was developed by the
2170 appraiser, summarize the support and rationale for that opinion;**

2171 Comment: In the context of personal property, value can be a function of the current
2172 and alternative use of the subject property, the choice of the appropriate market or
2173 market level for the type of item, the type and definition of value, and intended use
2174 of the report.

⁸⁵ See Advisory Opinion 28, *Scope of Work Decision, Performance, and Disclosure* and Advisory Opinion 29, *An Acceptable Scope of Work*.

⁸⁶ See Advisory Opinion 31, *Assignments Involving More than One Appraiser*.

⁸⁷ See Advisory Opinion 2, *Inspection of Subject Property*.

- 2175 (x) clearly and conspicuously:
- 2176 • state all extraordinary assumptions and hypothetical conditions; and
- 2177 • state that their use might have affected the assignment results; and
- 2178 (xi) include a signed certification in accordance with Standards Rule 8-3.
- 2179 (c) The content of a Restricted Use Appraisal Report must be consistent with the intended use of the
- 2180 appraisal and, at a minimum:
- 2181 (i) state the identity of the client, by name or type;⁸⁸ and state a prominent use restriction
- 2182 that limits use of the report to the client and warns that the appraiser's opinions and
- 2183 conclusions set forth in the report may not be understood properly without additional
- 2184 information in the appraiser's workfile;
- 2185 Comment: An appraiser must use care when identifying the client to ensure a clear
- 2186 understanding and to avoid violations of the Confidentiality section of the ETHICS
- 2187 RULE. In those rare instances when the client wishes to remain anonymous, an
- 2188 appraiser must still document the identity of the client in the workfile but may omit
- 2189 the client's identity in the report.
- 2190 The Restricted Use Appraisal Report is for client use only. Before entering into an
- 2191 agreement, the appraiser should establish with the client the situations where this
- 2192 type of report is to be used and should ensure that the client understands the
- 2193 restricted utility of the Restricted Use Appraisal Report.
- 2194 (ii) state the intended use of the appraisal;⁸⁹
- 2195 Comment: The intended use of the appraisal must be consistent with the limitation
- 2196 on use of the Restricted Use Appraisal Report option in this Standards Rule (i.e.,
- 2197 client use only).
- 2198 (iii) state information sufficient to identify the property involved in the appraisal;
- 2199 (iv) state the property interest appraised;
- 2200 (v) state the type of value and cite the source of its definition;⁹⁰
- 2201 Comment: When an opinion of reasonable exposure time has been developed in
- 2202 compliance with Standards Rule 7-2(c), the opinion must be stated in the report.
- 2203 (vi) state the effective date of the appraisal and the date of the report;⁹¹
- 2204 Comment: The effective date of the appraisal establishes the context for the value
- 2205 opinion, while the date of the report indicates whether the perspective of the

⁸⁸ See Statement on Appraisal Standards No. 9, *Identification of Intended Use and Intended Users*.

⁸⁹ See Statement on Appraisal Standards No. 9, *Identification of Intended Use and Intended Users*.

⁹⁰ See Statement on Appraisal Standards No. 6, *Reasonable Exposure Time in Real Property and Personal Property Opinions of Value*. See also Advisory Opinion 7, *Marketing Time Opinions*.

⁹¹ See Statement on Appraisal Standards No. 3, *Retrospective Value Opinions*, and Statement on Appraisal Standards No. 4, *Prospective Value Opinions*.

STANDARD 8

2206 appraiser on the market and property as of the effective date of the appraisal was
2207 prospective, current, or retrospective.

2208 **(vii) state the scope of work used to develop the appraisal;**⁹²

2209 Comment: Because the client's reliance on an appraisal may be affected by the scope
2210 of work, the report must enable them to be properly informed and not misled.
2211 Sufficient information includes disclosure of research and analyses performed and
2212 might also include disclosure of research and analyses not performed.

2213 When any portion of the work involves significant personal property appraisal
2214 assistance, the appraiser must state the extent of that assistance. The signing
2215 appraiser must also state the name(s) of those providing the significant personal
2216 property appraisal assistance in the certification, in accordance with Standards Rule
2217 8-3.⁹³

2218 **(viii) state the appraisal methods and techniques employed, state the value opinion(s) and**
2219 **conclusion(s) reached, and reference the workfile; exclusion of the sales comparison**
2220 **approach, cost approach, or income approach must be explained;**⁹⁴

2221 Comment: An appraiser must maintain a specific, coherent workfile in support of a
2222 Restricted Use Appraisal Report. The contents of the workfile must include sufficient
2223 information to indicate that the appraiser complied with the requirements of
2224 STANDARD 7 and for the appraiser to produce a Summary Appraisal Report.

2225 When reporting an opinion of market value, information analyzed in compliance
2226 with Standards Rule 7-5 is significant information that must be disclosed in a
2227 Restricted Use Appraisal Report. If such information was unobtainable, a statement
2228 on the efforts undertaken by the appraiser to obtain the information is required. If
2229 such information is irrelevant, a statement acknowledging the existence of the
2230 information and citing its lack of relevance is required.

2231 **(ix) state, as appropriate to the class of personal property involved, the use of the property**
2232 **existing as of the date of value and the use of the property reflected in the appraisal;**
2233 **and, when an opinion of the appropriate market or market level was developed by the**
2234 **appraiser, state that opinion;**

2235 Comment: In the context of personal property, value can be a function of the current
2236 and alternative use of the subject property, the choice of the appropriate market or
2237 market level for the type of item, the type and definition of value, and intended use
2238 of the report.

2239 **(x) clearly and conspicuously:**

- 2240 • state all extraordinary assumptions and hypothetical conditions; and
- 2241 • state that their use might have affected the assignment results; and

2242 **(xi) include a signed certification in accordance with Standards Rule 8-3.**

⁹² See Advisory Opinion 28, *Scope of Work Decision, Performance, and Disclosure* and Advisory Opinion 29, *An Acceptable Scope of Work*.

⁹³ See Advisory Opinion 31, *Assignments Involving More than One Appraiser*.

⁹⁴ See Advisory Opinion 2, *Inspection of Subject Property*.

2243 **Standards Rule 8-3**

2244 **Each written personal property appraisal report must contain a signed certification that is similar in**
 2245 **content to the following form:**

2246 **I certify that, to the best of my knowledge and belief:**

- 2247 — **the statements of fact contained in this report are true and correct.**
 2248 — **the reported analyses, opinions, and conclusions are limited only by the reported**
 2249 **assumptions and limiting conditions and are my personal, impartial, and unbiased**
 2250 **professional analyses, opinions, and conclusions.**
 2251 — **I have no (or the specified) present or prospective interest in the property that is the**
 2252 **subject of this report and no (or the specified) personal interest with respect to the**
 2253 **parties involved.**
 2254 — **I have performed no (or the specified) services, as an appraiser or in any other**
 2255 **capacity, regarding the property that is the subject of this report within the three-year**
 2256 **period immediately preceding acceptance of this assignment.**
 2257 — **I have no bias with respect to the property that is the subject of this report or to the**
 2258 **parties involved with this assignment.**
 2259 — **my engagement in this assignment was not contingent upon developing or reporting**
 2260 **predetermined results.**
 2261 — **my compensation for completing this assignment is not contingent upon the**
 2262 **development or reporting of a predetermined value or direction in value that favors**
 2263 **the cause of the client, the amount of the value opinion, the attainment of a stipulated**
 2264 **result, or the occurrence of a subsequent event directly related to the intended use of**
 2265 **this appraisal.**
 2266 — **my analyses, opinions, and conclusions were developed, and this report has been**
 2267 **prepared, in conformity with the *Uniform Standards of Professional Appraisal Practice*.**
 2268 — **I have (or have not) made a personal inspection of the property that is the subject of**
 2269 **this report. (If more than one person signs this certification, the certification must**
 2270 **clearly specify which individuals did and which individuals did not make a personal**
 2271 **inspection of the appraised property.)⁹⁵**
 2272 — **no one provided significant personal property appraisal assistance to the person**
 2273 **signing this certification. (If there are exceptions, the name of each individual**
 2274 **providing significant personal property appraisal assistance must be stated.)**

2275 Comment: A signed certification is an integral part of the appraisal report. An appraiser who
 2276 signs any part of the appraisal report, including a letter of transmittal, must also sign this
 2277 certification.

2278 In an assignment that includes only assignment results developed by the personal property
 2279 appraiser(s), any appraiser(s) who signs a certification accepts full responsibility for all
 2280 elements of the certification, for the assignment results, and for the contents of the appraisal
 2281 report. In an assignment that includes real property, business or intangible asset assignment
 2282 results not developed by the personal property appraiser(s), any personal property appraiser(s)
 2283 who signs a certification accepts full responsibility for the personal property elements of the
 2284 certification, for the personal property assignment results, and for the personal property
 2285 contents of the appraisal report.

⁹⁵ See Advisory Opinion 2, *Inspection of Subject Property*.

STANDARD 8

2286 When a signing appraiser(s) has relied on work done by appraisers and others who do not sign
2287 the certification, the signing appraiser is responsible for the decision to rely on their work.
2288 The signing appraiser(s) is required to have a reasonable basis for believing that those
2289 individuals performing the work are competent. The signing appraiser(s) also must have no
2290 reason to doubt that the work of those individuals is credible.⁹⁶

2291 The names of individuals providing significant personal property appraisal assistance who do
2292 not sign a certification must be stated in the certification. It is not required that the description
2293 of their assistance be contained in the certification, but disclosure of their assistance is
2294 required in accordance with Standards Rule 8-2(a), (b), or (c)(vii), as applicable.⁹⁷

2295 Standards Rule 8-4

2296 **To the extent that it is both possible and appropriate, an oral personal property appraisal report must**
2297 **address the substantive matters set forth in Standards Rule 8-2(b).**

2298 Comment: See the RECORD KEEPING RULE for corresponding requirements.

⁹⁶ See Advisory Opinion 5, *Assistance in the Preparation of an Appraisal*.

⁹⁷ See Advisory Opinion 31, *Assignments Involving More than One Appraiser*.

2299 **STANDARD 9: BUSINESS APPRAISAL, DEVELOPMENT**

2300 **In developing an appraisal of an interest in a business enterprise or intangible asset, an appraiser must**
 2301 **identify the problem to be solved, determine the scope of work necessary to solve the problem, and**
 2302 **correctly complete the research and analyses necessary to produce a credible appraisal.**

2303 Comment: STANDARD 9 is directed toward the substantive aspects of developing a credible
 2304 appraisal of an interest in a business enterprise or intangible asset.

2305 **Standards Rule 9-1**

2306 **In developing an appraisal of an interest in a business enterprise or intangible asset, an appraiser must:**

2307 **(a) be aware of, understand, and correctly employ those recognized approaches, methods and**
 2308 **procedures that are necessary to produce a credible appraisal;**

2309 Comment: Changes and developments in the economy and in investment theory have a
 2310 substantial impact on the business and intangible asset appraisal profession. Important
 2311 changes in the financial arena, securities regulation, financial reporting requirements, and law
 2312 may result in corresponding changes in appraisal theory and practice.

2313 **(b) not commit a substantial error of omission or commission that significantly affects an appraisal;**
 2314 **and**

2315 Comment: An appraiser must use sufficient care to avoid errors that would significantly affect
 2316 his or her opinions and conclusions. Diligence is required to identify and analyze the factors,
 2317 conditions, data, and other information that would have a significant effect on the credibility
 2318 of the assignment results.

2319 **(c) not render appraisal services in a careless or negligent manner, such as by making a series of**
 2320 **errors that, although individually might not significantly affect the results of an appraisal, in the**
 2321 **aggregate affect the credibility of those results.**

2322 Comment: Perfection is impossible to attain, and competence does not require perfection.
 2323 However, an appraiser must not render appraisal services in a careless or negligent manner.
 2324 This Standards Rule requires an appraiser to use due diligence and due care.

2325 **Standards Rule 9-2**

2326 **In developing an appraisal of an interest in a business enterprise or intangible asset, an appraiser must:**

2327 **(a) identify the client and other intended users;⁹⁸**

2328 **(b) identify the intended use of the appraiser's opinions and conclusions;⁹⁹**

2329 Comment: An appraiser must not allow the intended use of an assignment or a client's
 2330 objectives to cause the assignment results to be biased.

2331 **(c) identify the standard (type) and definition of value and the premise of value;**

⁹⁸ See Statement on Appraisal Standards No. 9, *Identification of Intended Use and Intended Users*.

⁹⁹ See Statement on Appraisal Standards No. 9, *Identification of Intended Use and Intended Users*.

STANDARD 9

- 2332 (d) identify the effective date of the appraisal;
- 2333 (e) identify the characteristics of the subject property that are relevant to the standard (type) and
2334 definition of value and intended use of the appraisal, including:
- 2335 (i) the subject business enterprise or intangible asset, if applicable;
- 2336 (ii) the interest in the business enterprise, equity, asset, or liability to be valued;
- 2337 Comment: The interest to be valued may represent all ownership rights or a subset
2338 of those rights, such as a specific right to use the asset.
- 2339 (iii) all buy-sell and option agreements, investment letter stock restrictions, restrictive
2340 corporate charter or partnership agreement clauses, and similar features or factors that
2341 may have an influence on value;
- 2342 (iv) the extent to which the interest contains elements of ownership control; and
- 2343 Comment: The elements of control in a given situation may be affected by law,
2344 distribution of ownership interests, contractual relationships, and many other factors.
- 2345 (v) the extent to which the interest is marketable and/or liquid;
- 2346 Comment on (i)-(v): An appraiser must identify the attributes of the interest being appraised,
2347 including the rights and benefits of ownership.
- 2348 The information used by an appraiser to identify the property characteristics must be from
2349 sources the appraiser reasonably believes are reliable.
- 2350 (f) identify any extraordinary assumptions necessary in the assignment;
- 2351 Comment: An extraordinary assumption may be used in an assignment only if:
- 2352 • it is required to properly develop credible opinions and conclusions;
- 2353 • the appraiser has a reasonable basis for the extraordinary assumption;
- 2354 • use of the extraordinary assumption results in a credible analysis; and
- 2355 • the appraiser complies with the disclosure requirements set forth in USPAP for
2356 extraordinary assumptions.
- 2357 (g) identify any hypothetical conditions necessary in the assignment; and
- 2358 Comment: A hypothetical condition may be used in an assignment only if:
- 2359 • use of the hypothetical condition is clearly required for legal purposes, for purposes
2360 of reasonable analysis, or for purposes of comparison;
- 2361 • use of the hypothetical condition results in a credible analysis; and
- 2362 • the appraiser complies with the disclosure requirements set forth in USPAP for
2363 hypothetical conditions.

- 2364 (h) determine the scope of work necessary to produce credible assignment results in accordance with
2365 the SCOPE OF WORK RULE.¹⁰⁰

2366 **Standards Rule 9-3**

2367 **In developing an appraisal of an equity interest in a business enterprise with the ability to cause**
2368 **liquidation, an appraiser must investigate the possibility that the business enterprise may have a higher**
2369 **value by liquidation of all or part of the enterprise than by continued operation as is. If liquidation of all**
2370 **or part of the enterprise is the indicated premise of value, an appraisal of any real property or personal**
2371 **property to be liquidated may be appropriate.**

2372 Comment: This Standards Rule requires the appraiser to recognize that continued operation of
2373 a business is not always the best premise of value because liquidation of all or part of the
2374 enterprise may result in a higher value. However, this typically applies only when the business
2375 equity being appraised is in a position to cause liquidation. If liquidation of all or part of the
2376 enterprise is the appropriate premise of value, the scope of work may include an appraisal of
2377 real property or tangible personal property. If so, competency in real property appraisal
2378 (STANDARD 1) or tangible personal property appraisal (STANDARD 7) is required.

2379 **Standards Rule 9-4**

2380 **In developing an appraisal of an interest in a business enterprise or intangible asset, an appraiser must**
2381 **collect and analyze all information necessary for credible assignment results.**

2382 (a) **An appraiser must develop value opinion(s) and conclusion(s) by use of one or more approaches**
2383 **that are necessary for credible assignment results.**

2384 (b) **An appraiser must, when necessary for credible assignment results, analyze the effect on value, if**
2385 **any, of:**

2386 (i) **the nature and history of the business enterprise or intangible asset;**

2387 (ii) **financial and economic conditions affecting the business enterprise or intangible asset,**
2388 **its industry, and the general economy;**

2389 (iii) **past results, current operations, and future prospects of the business enterprise;**

2390 (iv) **past sales of capital stock or other ownership interests in the business enterprise or**
2391 **intangible asset being appraised;**

2392 (v) **sales of capital stock or other ownership interests in similar business enterprises;**

2393 (vi) **prices, terms, and conditions affecting past sales of similar ownership interests in the**
2394 **asset being appraised or a similar asset; and**

2395 (vii) **economic benefit of tangible and intangible assets.**

2396 Comment on (i)-(vii): This Standards Rule directs the appraiser to study the prospective and
2397 retrospective aspects of the business enterprise and to study it in terms of the economic and
2398 industry environment within which it operates.

¹⁰⁰ See Advisory Opinion 28, *Scope of Work Decision, Performance, and Disclosure*, and Advisory Opinion 29, *An Acceptable Scope of Work*.

STANDARD 9

2399 (c) An appraiser must, when necessary for credible assignment results, analyze the effect on value, if
2400 any, of buy-sell and option agreements, investment letter stock restrictions, restrictive corporate
2401 charter or partnership agreement clauses, and similar features or factors that may influence
2402 value.

2403 (d) An appraiser must, when necessary for credible assignment results, analyze the effect on value, if
2404 any, of the extent to which the interest appraised contains elements of ownership control and is
2405 marketable and/or liquid.

2406 Comment: An appraiser must analyze factors such as holding period, interim benefits, and the
2407 difficulty and cost of marketing the subject interest.

2408 Equity interests in a business enterprise are not necessarily worth the pro rata share of the
2409 business enterprise interest value as a whole. Also, the value of the business enterprise is not
2410 necessarily a direct mathematical extension of the value of the fractional interests. The degree
2411 of control, marketability and/or liquidity or lack thereof depends on a broad variety of facts
2412 and circumstances that must be analyzed when applicable.

2413 Standards Rule 9-5

2414 **In developing an appraisal of an interest in a business enterprise or intangible asset, an appraiser must:**

2415 (a) **reconcile the quality and quantity of data available and analyzed within the approaches,**
2416 **methods, and procedures used; and**

2417 (b) **reconcile the applicability and relevance of the approaches, methods and procedures used to**
2418 **arrive at the value conclusion(s).**

2419 Comment: The value conclusion is the result of the appraiser's judgment and not necessarily
2420 the result of a mathematical process.

2421 **STANDARD 10: BUSINESS APPRAISAL, REPORTING**

2422 **In reporting the results of an appraisal of an interest in a business enterprise or intangible asset, an**
2423 **appraiser must communicate each analysis, opinion, and conclusion in a manner that is not misleading.**

2424 Comment: STANDARD 10 addresses the content and level of information required in a report that
2425 communicates the results of an appraisal of an interest in a business enterprise or intangible asset
2426 developed under STANDARD 9.

2427 STANDARD 10 does not dictate the form, format, or style of business or intangible asset
2428 appraisal reports, which are functions of the needs of intended users and appraisers. The
2429 substantive content of a report determines its compliance.

2430 **Standards Rule 10-1**

2431 **Each written or oral appraisal report for an interest in a business enterprise or intangible asset must:**

- 2432 **(a) clearly and accurately set forth the appraisal in a manner that will not be misleading;**
2433 **(b) contain sufficient information to enable the intended user(s) to understand the report; and**
2434 **(c) clearly and accurately disclose all assumptions, extraordinary assumptions, hypothetical**
2435 **conditions, and limiting conditions used in the assignment.**

2436 **Standards Rule 10-2**

2437 **Each written appraisal report for an interest in a business enterprise or intangible asset must be**
2438 **prepared in accordance with one of the following options and prominently state which option is used:**
2439 **Appraisal Report or Restricted Use Appraisal Report.**

2440 Comment: When the intended users include parties other than the client, an Appraisal Report
2441 must be provided. When the intended users do not include parties other than the client, a
2442 Restricted Use Appraisal Report may be provided.

2443 The essential difference between these options is in the content and level of information
2444 provided. The appropriate reporting option and the level of information necessary in the
2445 report are dependent on the intended use and intended users.

2446 An appraiser must use care when characterizing the type of report and level of information
2447 communicated upon completion of an assignment. An appraiser may use any other label in
2448 addition to, but not in place of, the label set forth in this Standard for the type of report
2449 provided.

2450 The report content and level of information requirements set forth in this Standard are
2451 minimums for both types of report.

2452 A party receiving a copy of an Appraisal Report or Restricted Use Appraisal Report does not
2453 become an intended user of the appraisal unless the appraiser identifies such party as an
2454 intended user as part of the assignment.

- 2455 **(a) The content of an Appraisal Report must be consistent with the intended use of the appraisal**
2456 **and, at a minimum:**

STANDARD 10

- 2457 **(i) state the identity of the client and any other intended users, by name or type;**¹⁰¹
- 2458 Comment: An appraiser must use care when identifying the client to ensure a clear
2459 understanding and to avoid violations of the Confidentiality section of the ETHICS
2460 RULE. In those rare instances when the client wishes to remain anonymous, an
2461 appraiser must still document the identity of the client in the workfile but may omit
2462 the client's identity in the report.
- 2463 **(ii) state the intended use of the appraisal;**¹⁰²
- 2464 **(iii) summarize information sufficient to identify the business or intangible asset and the**
2465 **interest appraised;**
- 2466 Comment: The identification information must include property characteristics
2467 relevant to the type and definition of value and intended use of the appraisal.
- 2468 **(iv) state the extent to which the interest appraised contains elements of ownership control,**
2469 **including the basis for that determination;**
- 2470 **(v) state the extent to which the interest appraised lacks elements of marketability and/or**
2471 **liquidity, including the basis for that determination;**
- 2472 **(vi) state the standard (type) and definition of value and the premise of value and cite the**
2473 **source of the definition;**
- 2474 Comment: Stating the definition of value also requires any comments needed to
2475 clearly indicate to the intended users how the definition is being applied.
- 2476 **(vii) state the effective date of the appraisal and the date of the report;**
- 2477 Comment: The effective date of the appraisal establishes the context for the value
2478 opinion, while the date of the report indicates whether the perspective of the
2479 appraiser on the market or property as of the effective date of the appraisal was
2480 prospective, current, or retrospective.
- 2481 **(viii) summarize the scope of work used to develop the appraisal;**¹⁰³
- 2482 Comment: Because intended users' reliance on an appraisal may be affected by the
2483 scope of work, the report must enable them to be properly informed and not misled.
2484 Sufficient information includes disclosure of research and analyses performed and
2485 might also include disclosure of research and analyses not performed.
- 2486 When any portion of the work involves significant business and/or intangible asset
2487 appraisal assistance, the appraiser must summarize the extent of that assistance. The
2488 signing appraiser must also state the name(s) of those providing the significant

¹⁰¹ See Statement on Appraisal Standards No. 9, *Identification of Intended Use and Intended Users*.

¹⁰² See Statement on Appraisal Standards No. 9, *Identification of Intended Use and Intended Users*.

¹⁰³ See Advisory Opinion 28, *Scope of Work Decision, Performance, and Disclosure*, and Advisory Opinion 29, *An Acceptable Scope of Work*.

- 2489 business and/or intangible asset appraisal assistance in the certification, in
2490 accordance with Standards Rule 10-3.¹⁰⁴
- 2491 **(ix) summarize the information analyzed, the appraisal procedures followed, and the**
2492 **reasoning that supports the analyses, opinions, and conclusions; exclusion of the market**
2493 **approach, asset-based (cost) approach, or income approach must be explained;**
- 2494 Comment: An Appraisal Report must include sufficient information to indicate that
2495 the appraiser complied with the requirements of STANDARD 9. The amount of
2496 detail required will vary with the significance of the information to the appraisal.
- 2497 The appraiser must provide sufficient information to enable the client and intended
2498 users to understand the rationale for the opinions and conclusions, including
2499 reconciliation in accordance with Standards Rule 9-5.
- 2500 **(x) clearly and conspicuously:**
- 2501 • state all extraordinary assumptions and hypothetical conditions; and
 - 2502 • state that their use might have affected the assignment results; and
- 2503 **(xi) include a signed certification in accordance with Standards Rule 10-3.**
- 2504 **(b) The content of a Restricted Use Appraisal Report must be consistent with the intended use of the**
2505 **appraisal and, at a minimum:**
- 2506 **(i) state the identity of the client, by name or type;¹⁰⁵ and state a prominent use restriction**
2507 **that limits use of the report to the client and warns that the appraiser’s opinions and**
2508 **conclusions set forth in the report may not be understood properly without additional**
2509 **information in the appraiser’s workfile;**
- 2510 Comment: An appraiser must use care when identifying the client to ensure a clear
2511 understanding and to avoid violations of the Confidentiality section of the ETHICS
2512 RULE. In those rare instances when the client wishes to remain anonymous, an
2513 appraiser must still document the identity of the client in the workfile but may omit
2514 the client’s identity in the report.
- 2515 The Restricted Use Appraisal Report is for client use only. Before entering into an
2516 agreement, the appraiser should establish with the client the situations where this
2517 type of report is to be used and should ensure that the client understands the
2518 restricted utility of the Restricted Use Appraisal Report.
- 2519 **(ii) state the intended use of the appraisal;¹⁰⁶**
- 2520 Comment: The intended use of the appraisal must be consistent with the limitation
2521 on use of the Restricted Use Appraisal Report option in this Standards Rule (i.e.
2522 client use only).
- 2523 **(iii) state information sufficient to identify the business or intangible asset and the interest**
2524 **appraised;**

¹⁰⁴ See Advisory Opinion 31, *Assignments Involving More than One Appraiser*.

¹⁰⁵ See Statement on Appraisal Standards No. 9, *Identification of Intended Use and Intended Users*.

¹⁰⁶ See Statement on Appraisal Standards No. 9, *Identification of Intended Use and Intended Users*.

STANDARD 10

- 2525 Comment: The identification information must include property characteristics
2526 relevant to the type and definition of value and intended use of the appraisal.
- 2527 **(iv) state the extent to which the interest appraised contains elements of ownership control,
2528 including the basis for that determination;**
- 2529 **(v) state the extent to which the interest appraised lacks elements of marketability and/or
2530 liquidity, including the basis for that determination;**
- 2531 **(vi) state the standard (type) of value and the premise of value, and cite the source of its
2532 definition;**
- 2533 **(vii) state the effective date of the appraisal and the date of the report;**
- 2534 Comment: The effective date of the appraisal establishes the context for the value
2535 opinion, while the date of the report indicates whether the perspective of the
2536 appraiser on the market or property as of the effective date of the appraisal was
2537 prospective, current, or retrospective.
- 2538 **(viii) state the scope of work used to develop the appraisal;¹⁰⁷**
- 2539 Comment: Because the client's reliance on an appraisal may be affected by the scope
2540 of work, the report must enable them to be properly informed and not misled.
2541 Sufficient information includes disclosure of research and analyses performed and
2542 might also include disclosure of research and analyses not performed.
- 2543 When any portion of the work involves significant business and/or intangible asset
2544 appraisal assistance, the appraiser must state the extent of that assistance. The
2545 signing appraiser must also state the name(s) of those providing the significant
2546 business and/or intangible asset appraisal assistance in the certification, in
2547 accordance with Standards Rule 10-3.¹⁰⁸
- 2548 **(ix) state the appraisal procedures followed, state the value opinion(s) and conclusion(s)
2549 reached, and reference the workfile; exclusion of the market approach, asset-based
2550 (cost) approach, or income approach must be explained;**
- 2551 Comment: An appraiser must maintain a specific, coherent workfile in support of a
2552 Restricted Use Appraisal Report. The contents of the workfile must include sufficient
2553 information to indicate that the appraiser complied with the requirements of
2554 STANDARD 9 and for the appraiser to produce an Appraisal Report.
- 2555 **(x) clearly and conspicuously:**
- 2556
 - state all extraordinary assumptions and hypothetical conditions; and
 - state that their use might have affected the assignment results; and
- 2557
- 2558 **(xi) include a signed certification in accordance with Standards Rule 10-3.**

¹⁰⁷ See Advisory Opinion 28, *Scope of Work Decision, Performance, and Disclosure* and Advisory Opinion 29, *An Acceptable Scope of Work*.

¹⁰⁸ See Advisory Opinion 31, *Assignments Involving More than One Appraiser*.

2559 **Standards Rule 10-3**

2560 **Each written appraisal report for an interest in a business enterprise or intangible asset must contain a**
 2561 **signed certification that is similar in content to the following form:**

2562 **I certify that, to the best of my knowledge and belief:**

- 2563 — **the statements of fact contained in this report are true and correct.**
- 2564 — **the reported analyses, opinions, and conclusions are limited only by the reported**
 2565 **assumptions and limiting conditions and are my personal, impartial, and unbiased**
 2566 **professional analyses, opinions, and conclusions.**
- 2567 — **I have no (or the specified) present or prospective interest in the property that is the**
 2568 **subject of this report, and I have no (or the specified) personal interest with respect to**
 2569 **the parties involved.**
- 2570 — **I have performed no (or the specified) services, as an appraiser or in any other capacity,**
 2571 **regarding the property that is the subject of this report within the three-year period**
 2572 **immediately preceding acceptance of this assignment.**
- 2573 — **I have no bias with respect to the property that is the subject of this report or to the**
 2574 **parties involved with this assignment.**
- 2575 — **my engagement in this assignment was not contingent upon developing or reporting**
 2576 **predetermined results.**
- 2577 — **my compensation for completing this assignment is not contingent upon the**
 2578 **development or reporting of a predetermined value or direction in value that favors**
 2579 **the cause of the client, the amount of the value opinion, the attainment of a stipulated**
 2580 **result, or the occurrence of a subsequent event directly related to the intended use of**
 2581 **this appraisal.**
- 2582 — **my analyses, opinions, and conclusions were developed, and this report has been**
 2583 **prepared, in conformity with the *Uniform Standards of Professional Appraisal Practice*.**
 2584 — **no one provided significant business and/or intangible asset appraisal assistance to the**
 2585 **person signing this certification. (If there are exceptions, the name of each individual**
 2586 **providing significant business and/or intangible asset appraisal assistance must be**
 2587 **stated.)**

2588 Comment: A signed certification is an integral part of the appraisal report. An appraiser who
 2589 signs any part of the appraisal report, including a letter of transmittal, must also sign this
 2590 certification.

2591 In an assignment that includes only assignment results developed by the business and/or
 2592 intangible asset appraiser(s), any appraiser(s) who signs a certification accepts full
 2593 responsibility for all elements of the certification, for the assignment results, and for the
 2594 contents of the appraisal report. In an assignment that includes real property or personal
 2595 property assignment results not developed by the business and/or intangible asset appraiser(s),
 2596 any business and/or intangible asset appraiser(s) who signs a certification accepts full
 2597 responsibility for the business and/or intangible asset elements of the certification, for the
 2598 business and/or intangible asset assignment results, and for the business and/or intangible
 2599 asset contents of the appraisal report.

2600 When a signing appraiser(s) has relied on work done by appraisers and others who do not sign
 2601 the certification, the signing appraiser is responsible for the decision to rely on their work.
 2602 The signing appraiser(s) is required to have a reasonable basis for believing that those

STANDARD 10

2603 individuals performing the work are competent. The signing appraiser(s) also must have no
2604 reason to doubt that the work of those individuals is credible.¹⁰⁹

2605 The names of individuals providing significant business and/or intangible asset appraisal
2606 assistance who do not sign a certification must be stated in the certification. It is not required
2607 that the description of their assistance be contained in the certification but disclosure of their
2608 assistance is required in accordance with Standards Rule 10-2(a) or (b)(vii), as applicable.¹¹⁰

2609 **Standards Rule 10-4**

2610 **To the extent that it is both possible and appropriate, an oral appraisal report for an interest in a**
2611 **business enterprise or intangible asset must address the substantive matters set forth in Standards Rule**
2612 **10-2(a).**

2613 Comment: See the RECORD KEEPING RULE for corresponding requirements.

¹⁰⁹ See Advisory Opinion 5, *Assistance in the Preparation of an Appraisal*.

¹¹⁰ See Advisory Opinion 31, *Assignments Involving More than One Appraiser*.

2614 **STATEMENT ON APPRAISAL STANDARDS NO. 1 (SMT-1)**

2615 **SUBJECT: Appraisal Review—Clarification of Comment on Standards Rule 3-1(g)**

2616 This Statement has been retired by action of the Appraisal Standards Board.

STATEMENT 2

2617 **STATEMENT ON APPRAISAL STANDARDS NO. 2 (SMT-2)**

2618 **SUBJECT: Discounted Cash Flow Analysis**

2619 **APPLICATION: Real Property**

2620 **THE ISSUE:**

2621 Discounted cash flow (DCF) analysis is an accepted analytical tool and method of valuation within the income
2622 capitalization approach to value. DCF is not a new method, but it did not enjoy widespread use until modern
2623 computer technology enabled appraisers to automate the process. Because DCF analysis is profit oriented and
2624 dependent on the analysis of uncertain future events, it is vulnerable to misuse. What steps can the appraiser
2625 take to avoid misuse of DCF analysis?

2626 **THE STATEMENT:**

2627 The acceptance of DCF analysis as a method of valuation began in the institutional real estate market and has
2628 spread to investment real estate in the general real estate market. DCF techniques may be applied in the
2629 valuation or analysis of proposed construction, land development, condominium development or conversion,
2630 rehabilitation development, and income-producing real estate of various types. DCF analysis is becoming a
2631 requirement of advisors, asset managers, fiduciaries, portfolio managers, syndicators, underwriters, and others
2632 dealing in investment-grade real estate. These users of appraisal services favor the inclusion of DCF analysis as
2633 a management tool in projecting cash flow and return expectations, capital requirements, refinancing
2634 opportunities, and timing of future property dispositions. DCF analysis is regarded as one of the best methods of
2635 replicating steps taken to reach investor buy/sell/hold decisions and is often a part of the exercise of due
2636 diligence in the evaluation of an investment.

2637 DCF methodology is based on the principle of anticipation - i.e., value is created by the anticipation of future
2638 benefits. DCF analysis reflects investment criteria and requires the appraiser to make empirical and subjective
2639 assumptions. DCF analysis can be used for investment value and market value appraisals, as well as for other
2640 purposes such as sensitivity tests.

2641 DCF analysis is an additional tool available to the appraiser and is best applied in developing value opinions in
2642 the context of one or more other approaches. This statement focuses on the criteria for proper DCF analysis and
2643 does not imply that DCF analysis is or should be the only method employed.

2644 To avoid misuse or misunderstanding when DCF analysis is used in an appraisal assignment to develop an
2645 opinion of market value, it is the responsibility of the appraiser to ensure that the controlling input is consistent
2646 with market evidence and prevailing market attitudes. Market value DCF analyses should be supported by
2647 market derived data, and the assumptions should be both market and property specific. Market value DCF
2648 analyses, along with available factual data, are intended to reflect the expectations and perceptions of market
2649 participants. They should be judged on the support for the forecasts that existed when made, not on whether
2650 specific items in the forecasts are realized at a later date. An appraisal report that includes the results of DCF
2651 analysis must clearly state the assumptions on which the analysis is based and must set forth the relevant data
2652 used in the analysis.

2653 Standards Rule 1-1(b) states that the appraiser must not commit a substantial error of omission or commission
2654 that significantly affects an appraisal. Standards Rule 1-1(c) states that the appraiser must not render appraisal
2655 services in a careless or negligent manner, such as making a series of errors that, although individually might
2656 not significantly affect the results of an appraisal, in the aggregate would affect the credibility of those results.
2657 These two Standards Rules are significant for DCF analysis because of the potential for the compounding effect
2658 of errors in the input, unrealistic assumptions, and programming errors.

2659 Computer printouts showing the results of DCF analysis may be generated by commercial software or by
2660 software prepared by the appraiser. Either way, the appraiser is responsible for the entire analysis including the
2661 controlling input, the calculations, and the resulting output. If using commercial software the appraiser should
2662 cite the name and version of the software and provide a brief description of the methods and assumptions
2663 inherent in the software. Standards Rule 1-4(c)(iv) requires that projections of anticipated future rent and/or
2664 income potential and expenses be based on reasonably clear and appropriate evidence. The Comment to this
2665 Standards Rule makes specific reference to cash flow projections, the essence of DCF analysis.

2666 DCF accounts for and reflects those items and forces that affect the revenue, expenses, and ultimate earning
2667 capacity of real estate and represents a forecast of events that would be considered likely within a specific
2668 market. For example, in the appraisal of a multi-tenant property, a lease-by-lease analysis addresses contract
2669 and market rents, specific escalations, operating expenses, pass-through provisions, market-derived or specific
2670 concessions, capital expenditures, and any other measurable specific provisions applicable. Revenue growth
2671 rate or decline rate assumptions are premised on analysis of supply/demand factors and other economic
2672 conditions and trends within the market area of the subject. Operating expense change rates should reflect both
2673 overall expense trends and the specific trend of significant expense items.

2674 Discount rates applied to cash flows and estimates of reversion should be derived from data and information in
2675 the real estate and capital markets. Surveys of investor opinion and yield indices are also useful in the rate
2676 selection process, but only when the type of and market for the real estate being appraised is consistent with the
2677 type of and market for the real estate typically acquired by the investors interviewed in the survey.
2678 Considerations used in the selection of rates are risk, inflation, and real rates of return.

2679 When reversion capitalization rates are used, they should reflect investor expectations considering the real
2680 estate type, age and condition, cash flow characteristics, and related factors. The projection period is a variable
2681 and should be set on the basis of the facts and circumstances of each analysis.

2682 The results of DCF analysis should be tested and checked for errors and reasonableness. Because of the
2683 compounding effects in the projection of income and expenses, even slight input errors can be magnified and
2684 can produce unreasonable results. For example, it is good practice to test whether cash flows are changing at
2685 reasonable rates and to compare the reversion capitalization rate with the inferred entrance capitalization rate to
2686 see if the relationship between these rates is reasonable and explainable.

2687 STANDARD 2 requires the appraiser to communicate each analysis, opinion, and conclusion in a manner that is
2688 not misleading. Appraisals using the DCF method in the income capitalization approach may contain
2689 computerized projections of itemized future cash flow supported by exhaustive printouts that can be misleading.
2690 The seeming precision of computer-generated projections may give the appearance of certainty to projections
2691 that are actually variable within a wide range. In DCF analysis, all of the assumptions (growth rates, decline
2692 rates, rental rates, discount rates, financing terms, expense trends, capitalization rates, etc.) directly affect the
2693 conclusion and must be clearly and accurately disclosed in the appraisal report.

2694 **CONCLUSIONS:**

- 2695 • DCF analysis is an additional tool available to the appraiser and is best applied in
2696 developing value opinions in the context of one or more other approaches.
- 2697 • It is the responsibility of the appraiser to ensure that the controlling input is
2698 consistent with market evidence and prevailing market attitudes.
- 2699 • Market value DCF analyses should be supported by market-derived data, and the
2700 assumptions should be both market- and property-specific.
- 2701 • If using commercial software the appraiser should cite the name and version of the
2702 software and provide a brief description of the methods and assumptions inherent in
2703 the software.

STATEMENT 2

- 2704 • DCF accounts for and reflects those items and forces that affect the revenue,
2705 expenses, and ultimate earning capacity of real estate and represents a forecast of
2706 events that would be considered likely within a specific market.
- 2707 • The results of DCF analysis should be tested and checked for errors and
2708 reasonableness.
- 2709 • Standards Rule 1-1(b) states that the appraiser must not commit a substantial error of
2710 omission or commission that significantly affects an appraisal.

2711 **STATEMENT ON APPRAISAL STANDARDS NO. 3 (SMT-3)**2712 **SUBJECT: Retrospective Value Opinions**2713 **APPLICATION: Real Property, Personal Property**2714 **THE ISSUE:**

2715 Two dates are essential to an appraisal report. Standards Rules 2-2(a)(vi), (b)(vi), and (c)(vi), and 8-2(a)(vi),
2716 (b)(vi), and (c)(vi) require that each appraisal report specify the effective date of the appraisal and the date of
2717 the report. The date of the report indicates the perspective from which the appraiser is examining the market.
2718 The effective date of the appraisal establishes the context for the value opinion. Three categories of effective
2719 dates - retrospective, current, or prospective - may be used, according to the intended use of the appraisal
2720 assignment.

2721 When a retrospective effective date is used, how can the appraisal be prepared and presented in a manner that is
2722 not misleading?

2723 **THE STATEMENT:**

2724 Retrospective appraisals (effective date of the appraisal prior to the date of the report) may be required for
2725 property tax matters, estate or inheritance tax matters, condemnation proceedings, suits to recover damages, and
2726 similar situations.

2727 Current appraisals occur when the effective date of the appraisal is contemporaneous with the date of the report.
2728 Since most appraisals require current value opinions, the importance of specifying both the date of the report
2729 and the effective date of the analysis is sometimes lost.

2730 Prospective appraisals (effective date of the appraisal subsequent to the date of the report) may be required for
2731 valuations of property interests related to proposed developments, as the basis for value at the end of a cash
2732 flow projection, and for other reasons. (See SMT-4 on *Prospective Value Opinions*.)

2733 The use of clear and concise language and appropriate terminology in appraisal reports helps to eliminate
2734 misleading reports. To avoid confusion, the appraiser must clearly establish the date to which the value opinion
2735 applies. In retrospective value opinions, use of a modifier for the term “market value” and past verb tenses
2736 increases clarity (e.g., “. . . the retrospective market value was . . .” instead of “. . . the market value is . . .”).

2737 A retrospective appraisal is complicated by the fact that the appraiser already knows what occurred in the
2738 market after the effective date of the appraisal. Data subsequent to the effective date may be considered in
2739 developing a retrospective value as a confirmation of trends that would reasonably be considered by a buyer or
2740 seller as of that date. The appraiser should determine a logical cut-off because at some point distant from the
2741 effective date, the subsequent data will not reflect the relevant market. This is a difficult determination to make.
2742 Studying the market conditions as of the date of the appraisal assists the appraiser in judging where he or she
2743 should make this cut-off. In the absence of evidence in the market that data subsequent to the effective date
2744 were consistent with and confirmed market expectations as of the effective date, the effective date should be
2745 used as the cut-off date for data considered by the appraiser.

2746 Use of direct excerpts from then-current appraisal reports prepared at the time of the retrospective effective date
2747 helps the appraiser and the reader understand market conditions as of the retrospective effective date.

STATEMENT 3

2748 **CONCLUSIONS:**

- 2749 • A retrospective appraisal is complicated by the fact that the appraiser already knows
- 2750 what occurred in the market after the effective date of the appraisal.
- 2751 • Data subsequent to the effective date may be considered in developing a
- 2752 retrospective value as a confirmation of trends.
- 2753 • The appraiser should determine a logical cut-off.
- 2754 • Use of direct excerpts from then-current appraisal reports prepared at the time of the
- 2755 retrospective effective date helps the appraiser and the reader understand market
- 2756 conditions as of the retrospective effective date.
- 2757 • In the absence of evidence in the market that data subsequent to the effective date
- 2758 were consistent with and confirmed market expectations as of the effective date, the
- 2759 effective date should be used as the cut-off date.

2760 **STATEMENT ON APPRAISAL STANDARDS NO. 4 (SMT-4)**2761 **SUBJECT: Prospective Value Opinions**2762 **APPLICATION: Real Property, Personal Property**2763 **THE ISSUE:**

2764 Two dates are essential to an appraisal report. Standards Rules 2-2(a)(vi), (b)(vi), and (c)(vi), and 8-2(a)(vi),
2765 (b)(vi), and (c)(vi) require that each appraisal report specify the effective date of the appraisal and the date of
2766 the report. The date of the report indicates the perspective from which the appraiser is examining the market.
2767 The effective date of the appraisal establishes the context for the value opinion. Three categories of effective
2768 dates - retrospective, current, or prospective - may be used, according to the intended use of the appraisal
2769 assignment.

2770 When a prospective effective date is used, how can the appraisal be prepared and presented in a manner that is
2771 not misleading?

2772 **THE STATEMENT:**

2773 Retrospective appraisals (effective date of the appraisal prior to the date of the report) may be required for
2774 property tax matters, estate or inheritance tax matters, condemnation proceedings, suits to recover damages, and
2775 similar situations. (See SMT-3 on *Retrospective Value Opinions*.)

2776 Current appraisals occur when the effective date of the appraisal is contemporaneous with the date of the report.
2777 Since most appraisals require current value opinions, the importance of specifying both the date of the report
2778 and the effective date of the analysis is sometimes lost.

2779 Prospective appraisals (effective date of the appraisal subsequent to the date of the report) may be required for
2780 valuations of property interests related to proposed developments, as the basis for value at the end of a cash
2781 flow projection, and for other reasons.

2782 The use of clear and concise language and appropriate terminology in appraisal reports helps to eliminate
2783 misleading reports. To avoid confusion, the appraiser must clearly establish the date to which the value opinion
2784 applies. In prospective value opinions, use of the term “market value” without a modifier such as “forecasted”
2785 or “prospective” and without future verb tenses is improper (i.e., “...the prospective market value is expected to
2786 be...” and not “...the market value is...”).

2787 Prospective value opinions, along with available factual data, are intended to reflect the current expectations
2788 and perceptions of market participants. They should be judged on the support for the forecasts that existed when
2789 made, not on whether specific items in the forecasts are realized at a later date.

2790 When prospective value opinions are required with regard to proposed improvements to real property, the
2791 Comment to Standards Rule 1-2(e) regarding identification of the extent and character of the proposed
2792 improvements and Standards Rule 1-4(c)(iv) regarding the basis for anticipated future rent and expenses are
2793 relevant. Evidence that proposed improvements can be completed by the effective date of the appraisal is
2794 important. Support for projected income and expenses at the time of completion of proposed improvements and
2795 during the rent-up or sell-out period requires the incorporation of sufficient market research in the appraisal and
2796 the consideration of existing and future competition. It is appropriate to study comparable projects for evidence
2797 of construction periods, development costs, income and expense levels, and absorption. Items such as rental
2798 concessions, commissions, tenant finish allowances, add-on factors, and expense pass-throughs must be studied
2799 to develop realistic income expectancy. The same issues are relevant when appraising personal property with
2800 proposed modifications, as set forth in Standards Rules 7-2(e) and 7-4(c)(iv).

STATEMENT 4

2801 With regard to proposed developments of real property, two prospective value opinions may be required: one as
2802 of the time the development is to be completed and one as of the time the development is projected to achieve
2803 stabilized occupancy. These prospective values form a basis for investment decisions and loan underwriting.

2804 In a prospective appraisal, the appraiser analyzes market trends to provide support for forecasted income and
2805 expense or sell-out opinions, absorption periods, capitalization rates, and discount rates as of the effective date
2806 of the appraisal. Economic trends such as growth in population, employment, and future competition are also
2807 analyzed. The overall economic climate and variations in the business cycle should be considered and weighed
2808 in the performance of the appraisal process. All value conclusions should include reference to the time frame
2809 when the analysis was prepared to clearly delineate the market conditions and the point of reference from which
2810 the appraiser developed the prospective value opinion. It is essential to include a limiting condition citing the
2811 market conditions from which the prospective value opinion was made and indicating that the appraiser cannot
2812 be held responsible for unforeseeable events that alter market conditions prior to the effective date of the
2813 appraisal.

2814 CONCLUSIONS:

- 2815 • Prospective value opinions, along with available factual data, are intended to reflect
2816 the current expectations and perceptions of market participants. They should be
2817 judged on the market support for the forecasts when made, not on whether specific
2818 items in the forecasts are realized.
- 2819 • It is appropriate to study comparable projects for evidence of construction periods,
2820 development costs, income and expense levels, and absorption.
- 2821 • Items such as rental concessions, commissions, tenant finish allowances, add-on
2822 factors, and expense pass-throughs must be studied to develop realistic income
2823 expectancy.
- 2824 • All value conclusions should include reference to the time frame when the analysis
2825 was prepared to clearly delineate the market conditions and the point of reference
2826 from which the appraiser developed the prospective value opinion.
- 2827 • It is essential to include a limiting condition citing the market conditions from which
2828 the prospective value opinion was made and indicating that the appraiser cannot be
2829 held responsible for unforeseeable events that alter market conditions prior to the
2830 effective date of the appraisal.

2831 **STATEMENT ON APPRAISAL STANDARDS NO. 5 (SMT-5)**

2832 **SUBJECT: Confidentiality Section of the ETHICS RULE**

2833 This Statement has been retired by action of the Appraisal Standards Board.

STATEMENT 6

2834 STATEMENT ON APPRAISAL STANDARDS NO. 6 (SMT-6)

2835 **SUBJECT: Reasonable Exposure Time in Real Property and Personal Property Opinions of Value**

2836 **APPLICATION: Real Property, Personal Property**

2837 **THE ISSUE:**

2838 In USPAP, the Comment to Standards Rules 1-2(c) and Standards Rule 7-2(c) states:

2839 *When exposure time is a component of the definition for the value opinion being developed,*
2840 *the appraiser must also develop an opinion of reasonable exposure time linked to that value*
2841 *opinion.*

2842 The Comment to Standards Rules 2-2(a)(v), 2-2(b)(v), and 2-2(c)(v), states:

2843 *When an opinion of reasonable exposure time has been developed in compliance with*
2844 *Standards Rule 1-2(c), the opinion must be stated in the report.*

2845 Similar Comments appear in Standards Rules 8-2(a)(v), 8-2(b)(v), and 8-2(c)(v).

2846 How is the opinion of reasonable exposure time developed? Is it presumed to occur prior to or starting from the
2847 effective date of the appraisal?

2848 **THE STATEMENT:**

2849 Reasonable exposure time is one of a series of conditions in most market value definitions. Exposure time is
2850 always presumed to precede the effective date of the appraisal.

2851 The DEFINITIONS in USPAP include the following:

2852 ***EXPOSURE TIME:*** *estimated length of time that the property interest being appraised would have*
2853 *been offered on the market prior to the hypothetical consummation of a sale at market value on the*
2854 *effective date of the appraisal.*

2855 *Comment:* *Exposure time is a retrospective opinion based on an analysis of past events assuming a*
2856 *competitive and open market.*

2857 Exposure time is different for various types of property and under various market conditions. It is noted that the
2858 overall concept of reasonable exposure encompasses not only adequate, sufficient, and reasonable time but also
2859 adequate, sufficient, and reasonable effort. This statement focuses on the time component.

2860 The fact that exposure time is always presumed to occur prior to the effective date of the appraisal is
2861 substantiated by related facts in the appraisal process: supply/demand conditions as of the effective date of the
2862 appraisal; the use of current cost information; the analysis of historical sales information (sold after exposure
2863 and after completion of negotiations between the seller and buyer); and the analysis of future income
2864 expectancy projected from the effective date of the appraisal.

2865 **Rationale and Method for Developing an Opinion of Reasonable Exposure Time**

2866 The opinion of the time period for reasonable exposure is not intended to be a prediction of a date of sale or a
2867 one line statement. Instead, it is an integral part of the analyses conducted during the appraisal assignment. The
2868 opinion may be expressed as a range and can be based on one or more of the following.

- 2869
- statistical information about days on market;

- 2870 • information gathered through sales verification; and
2871 • interviews of market participants.

2872 Related information garnered through this process may include the identification of typical buyers and sellers
2873 for the type of property involved and typical equity investment levels and/or financing terms.

2874 The reasonable exposure period is a function of price, time, and use, not an isolated opinion of time alone. As
2875 an example, an office building, an important artwork, a fine gemstone, a process facility, or an aircraft could
2876 have been on the market for two years at a price of \$2,000,000, which informed market participants considered
2877 unreasonable. Then the owner lowered the price to \$1,600,000 and started to receive offers, culminating in a
2878 transaction at \$1,400,000 six months later. Although the actual exposure time was 2.5 years, the reasonable
2879 exposure time at a value range of \$1,400,000 to \$1,600,000 would be six months. The answer to the question
2880 “what is reasonable exposure time?” should always incorporate the answers to the question “for what kind of
2881 property at what value range?” rather than appear as a statement of an isolated time period.

2882 **Applications to Client Uses of an Appraisal**

2883 When an appraisal is commissioned as the result of a mortgage application after a potential seller and buyer
2884 enter into a Contract for Sale, no conflict exists between the presumption in the appraisal process that exposure
2885 time occurs prior to the effective date of the appraisal and the intended use of the appraisal.

2886 When an appraisal is commissioned for employee relocation, asset evaluation, foreclosure, or asset management
2887 purposes, the presumption in the appraisal process that exposure time occurs prior to the effective date of the
2888 appraisal may conflict with the intended use of the appraisal. Problems arise when clients attempt to make
2889 business decisions or account for assets without understanding the difference between reasonable exposure time
2890 and marketing time (see related Advisory Opinion 7, *Marketing Time Opinions*).

2891 **CONCLUSIONS:**

- 2892 • The reasonable exposure time inherent in the market value concept is always
2893 presumed to precede the effective date of the appraisal.
2894 • Exposure time is different for various types of property and under various market
2895 conditions.
2896 • The answer to the question “what is reasonable exposure time?” should always
2897 incorporate the answers to the question “for what kind of property at what value
2898 range?” rather than appear as a statement of an isolated time period.

STATEMENT 7

2899 **STATEMENT ON APPRAISAL STANDARDS NO. 7 (SMT-7)**

2900 **SUBJECT: Permitted Departure from Specific Requirements in Real Property and Personal Property**
2901 **Appraisal Assignments**

2902 This Statement has been retired by action of the Appraisal Standards Board.

2903 **STATEMENT ON APPRAISAL STANDARDS NO. 8 (SMT-8)**

2904 **SUBJECT: Electronic Transmission of Reports**

2905 This Statement has been retired by action of the Appraisal Standards Board.

STATEMENT 9

2906 **STATEMENT ON APPRAISAL STANDARDS NO. 9 (SMT- 9)**

2907 **SUBJECT: Identification of Intended Use and Intended Users**

2908 **APPLICATION: Real Property, Personal Property, Intangible Property**

2909 **THE ISSUE:**

2910 An appraiser must identify and consider the intended use and intended users of the appraiser's reported opinions
2911 and conclusions in order to identify the problem to be solved and to understand his or her development and
2912 reporting responsibilities in an appraisal, appraisal review, or appraisal consulting assignment. An appraiser
2913 must state the intended use and intended users of the opinions and conclusions in a report.

2914 What kind of information must an appraiser identify and consider regarding the intended use and intended users
2915 in the course of accepting and completing an assignment, and how much of that information must an appraiser
2916 include in the report?

2917 **THE STATEMENT:**

2918 **Relevant USPAP References**

2919 The term "Client" is defined in the DEFINITIONS section of USPAP as

2920 *the party or parties who engage, by employment or contract, an appraiser in a specific assignment.*

2921 Comment: The client may be an individual, group, or entity, and may engage and communicate with
2922 the appraiser directly or through an agent.

2923 The term "Intended Use" is defined as

2924 *the use or uses of an appraiser's reported appraisal, appraisal review, or appraisal consulting*
2925 *assignment opinions and conclusions, as identified by the appraiser based on communication*
2926 *with the client at the time of the assignment.*

2927 The term "Intended User" is defined as

2928 *the client and any other party as identified, by name or type, as users of the appraisal,*
2929 *appraisal review, or appraisal consulting report by the appraiser on the basis of*
2930 *communication with the client at the time of the assignment.*

2931 **General**

2932 The SCOPE OF WORK RULE requires an appraiser to identify the intended use and intended users as part of
2933 problem identification. Identifying the intended use and intended users is required to determine the scope of
2934 work necessary to develop credible assignment results. The credibility of assignment results is always measured
2935 in the context of their intended use.

2936 STANDARDS 1, 3, 4, 6, 7, and 9 require an appraiser to identify the intended use and intended users in the
2937 course of developing his or her opinions and conclusions in the assignment. In the context of a real property
2938 appraisal, Standards Rules 1-2(a) and (b) (for example) state:

2939 *In developing a real property appraisal, an appraiser must:*

2940 (a) *identify the client and other intended users;*

2941 (b) identify the intended use of the appraiser's opinions and conclusions...

2942 STANDARDS 2, 3, 5, 6, 8, and 10 require an appraiser to state the intended use in the report. In the context of a
2943 written real property appraisal report, Standards Rule 2-2(a) (for example) states, *The content of a Self-*
2944 *Contained Appraisal Report must be consistent with the **intended use** of the appraisal...* (bold added for
2945 emphasis).

2946 In the context of a real property appraisal report (for example), Standards Rules 2-2(a)(i) and (ii) require the
2947 appraiser to:

2948 (i) state the identity of the client and any intended users, by name or type;

2949 (ii) state the intended use of the appraisal...

2950 An appraiser identifies the intended use by communicating with the client before accepting an appraisal,
2951 appraisal review, or appraisal consulting assignment. The intended use may encompass requirements of
2952 intended users other than the client. An appraiser cannot reasonably identify the intended use without having
2953 identified the client and communicating with the client or the client's agent.

2954 Although an appraiser must identify and consider the intended use of the appraiser's opinions and conclusions,
2955 an appraiser must not allow the objectives of the client or other intended users of the report to affect the
2956 appraiser's independence and objectivity. An appraiser must not allow the objectives of a client or other
2957 intended users to cause the analysis or report to be biased.

2958 **Identification of the Client and Other Intended Users in an Assignment**

2959 In order to properly define the problem under study and to understand his or her responsibilities in an
2960 assignment, an appraiser must identify the client and other intended users. This is accomplished by
2961 communication with the client prior to accepting the assignment.

2962 An appraiser should use care when identifying the client to avoid violations of the Confidentiality section of the
2963 ETHICS RULE. The client may be identified as a person or entity, or as an agent of an intended user. In
2964 instances where the client wishes to remain anonymous, the appraiser must still document the identity of the
2965 client in the workfile but may omit the client's identity in the appraisal, appraisal review, or appraisal consulting
2966 report.

2967 Neither the client nor the appraiser is obligated to identify an intended user by name. If identification by name is
2968 not appropriate or practical, an appraiser's client and the appraiser may identify an intended user by type.

2969 An appraiser's obligations to the client are established in the course of considering and accepting an
2970 assignment. If an appraiser becomes aware of a change in the intended use of the report, the appraiser must
2971 consider whether the extent of the development process and type of report initially identified are still
2972 appropriate. If they are not, the appraiser must communicate with the client to establish an appropriate basis
2973 upon which to proceed.

2974 If the appraiser is contacted regarding an assignment or report by a party other than the appraiser's client, before
2975 responding the appraiser must review his or her obligations to that client. An appraiser may need to review the
2976 Confidentiality section of the ETHICS RULE and Advisory Opinions 25, 26, and 27 for guidance.

2977 An appraiser's obligations to other intended users may impose additional development and reporting
2978 requirements in the assignment. It is essential that an appraiser establish with the client a clear and mutual
2979 understanding of the needs of all intended users prior to accepting an assignment. An appraiser's obligation to
2980 intended users other than the client is limited to addressing their requirements as identified by the appraiser at
2981 the time the appraiser accepts the assignment.

STATEMENT 9

2982 A party receiving a report copy from the client does not, as a consequence, become a party to the appraiser-
2983 client relationship.

2984 Parties who receive a copy of an appraisal, appraisal review, or appraisal consulting report as a consequence of
2985 disclosure requirements applicable to an appraiser's client do not become intended users of the report unless
2986 they were specifically identified by the appraiser at the time of the assignment.

2987 **Disclosure of Client and Other Intended User(s) in an Appraisal, Appraisal Review, or Appraisal** 2988 **Consulting Report**

2989 Except when specifically requested not to do so as part of the agreement with the client, an appraiser must
2990 disclose the identity of the client and any other intended users in an appraisal, appraisal review, or appraisal
2991 consulting report. The purpose of this reporting requirement is to (1) ensure that the client and any other
2992 intended users can recognize their relationship to the assignment and report, and (2) ensure that unintended
2993 users will not be misled by notifying them that they are neither the client nor an intended user. For example, a
2994 statement similar to the following may be appropriate:

2995 This report is intended for use only by (identify the client) and (identify any other intended
2996 users by name or type). Use of this report by others is not intended by the appraiser.

2997 If the client's identity is omitted from an appraisal report, the appraiser must (1) identify the client in the
2998 workfile, and (2) provide a notice in the appraisal report that the identity of the client has been omitted in
2999 accordance with the client's request and that the report is intended for use only by the client and any other
3000 intended users.

3001 **Identification of the Intended Use in an Appraisal, Appraisal Review, or Appraisal Consulting** 3002 **Assignment**

3003 Identification of the intended use is one of the assignment elements necessary to properly identify the appraisal,
3004 appraisal review, or appraisal consulting problem. Identification of the intended use helps the appraiser and the
3005 client make two important decisions about the assignment:

- 3006 • the appropriate scope of work for the appraisal, appraisal review, or appraisal
3007 consulting development process; and
- 3008 • the level of detail to provide in the appraisal, appraisal review, or appraisal
3009 consulting report.

3010 **Disclosure of the Intended Use in an Appraisal, Appraisal Review, or Appraisal Consulting Report**

3011 An appraiser can avoid misleading parties in possession of an appraisal, appraisal review, or appraisal
3012 consulting report by clearly identifying the intended use in the report and stating that other uses are not
3013 intended. For example, a statement similar to the following may be appropriate:

3014 This report is intended only for use in (describe the use). This report is not intended for any other
3015 use.

3016 The intended use description provided in the statement must be specific to the assignment.

3017 **CONCLUSIONS:**

- 3018 • An appraiser must identify the client and other intended users as part of the process
3019 of identifying the client's intended use of an appraisal, appraisal review, or appraisal
3020 consulting report, by communication with the client prior to accepting the
3021 assignment.

- 3022 • Identification of the intended use and intended users are necessary steps in
3023 determining the appropriate scope of work.
- 3024 • Whether or not assignment results are credible is measured in the context of the
3025 intended use of the opinions and conclusions.
- 3026 • An appraiser should use care when identifying the client to ensure a clear
3027 understanding and to avoid violations of the Confidentiality section of the ETHICS
3028 RULE.
- 3029 • The appraiser's obligations to the client are established in the course of considering
3030 and accepting an assignment.
- 3031 • The appraiser's obligation to intended users other than the client is limited to
3032 addressing their requirements as identified by the appraiser at the time the appraiser
3033 accepts the assignment.
- 3034 • Identification of the intended use and intended users of the report is one of the
3035 essential steps in order to identify the problem to be solved.
- 3036 • An appraiser identifies the intended use and any intended users of an appraisal,
3037 appraisal review, or appraisal consulting report by communicating with the client
3038 before accepting an assignment.
- 3039 • Appraisers can avoid misleading parties in possession of a report by clearly
3040 identifying the intended use and any intended users in the report and stating that
3041 other uses and/or users are not intended by the appraiser.
- 3042 • Except when specifically requested not to do so as part of the agreement with the
3043 client, an appraiser must disclose the identity of the client and any other intended
3044 users of an appraisal report in the report.
- 3045 • If the client's identity is omitted from an appraisal report, the appraiser must (1)
3046 document the identity of the client in the workfile, and (2) provide a notice in the
3047 appraisal report that the identity of the client has been omitted in accordance with the
3048 client's request and that the report is intended for use only by the client and any other
3049 intended users.

STATEMENT 10

3050 **STATEMENT ON APPRAISAL STANDARDS NO. 10 (SMT-10)**

3051 **SUBJECT: Assignments for Use by a Federally Insured Depository Institution in a Federally Related**
3052 **Transaction**

3053 This Statement has been retired by action of the Appraisal Standards Board.

USPAP ADVISORY OPINIONS

2012-2013 EDITION

ADVISORY OPINIONS

USPAP ADVISORY OPINIONS

APPRAISAL STANDARDS BOARD



THE APPRAISAL FOUNDATION

*Authorized by Congress as the Source of Appraisal
Standards and Appraiser Qualifications*

USPAP ADVISORY OPINIONS

2012-2013 EDITION

APPRAISAL STANDARDS BOARD



THE APPRAISAL FOUNDATION

*Authorized by Congress as the Source of Appraisal
Standards and Appraiser Qualifications*

Published in the United States of America.

All rights reserved.

No parts of this publication may be reproduced, stored in a retrieval system, or transmitted in any form or by any means, electronic, mechanical, photocopy, recording or otherwise, without the prior written consent of the publisher.

EFFECTIVE:

**January 1, 2012 through
December 31, 2013**

APPRAISAL STANDARDS BOARD



THE APPRAISAL FOUNDATION

*Authorized by Congress as the Source of Appraisal
Standards and Appraiser Qualifications*

FOREWORD

The Appraisal Standards Board (ASB) of The Appraisal Foundation develops, interprets, and amends the *Uniform Standards of Professional Appraisal Practice* (USPAP) on behalf of appraisers and users of appraisal services. **The 2012-2013 edition of USPAP (2012-2013 USPAP) is effective January 1, 2012 through December 31, 2013.** It is important that individuals understand and adhere to changes in each edition of USPAP. State and federal authorities enforce the content of the current or applicable edition of USPAP.

Advisory Opinions are a form of guidance issued by the ASB to illustrate the applicability of USPAP in specific situations and to offer advice from the ASB for the resolution of appraisal issues and problems. Advisory Opinions do not establish new standards or interpret existing standards. Advisory Opinions are not part of USPAP and can be approved by the ASB without public exposure and comment.

Advisory Opinions are based on presumed conditions without investigation or verification of actual circumstances. Guidance provided in the Advisory Opinions does not represent the only possible solution to the issues discussed and the advice provided may not be applied equally to seemingly similar situations.

The *USPAP Advisory Opinions* are a reference for appraisers, enforcement officials, users of appraisal services, and the public. The use of this edition of the *USPAP Advisory Opinions* is intended to be in conjunction with the 2012-2013 Edition of USPAP.

Contacting the Appraisal Standards Board

The ASB invites questions about USPAP, commentary on USPAP and proposed changes to USPAP from all interested parties, including appraisers, state enforcement agencies, users of appraisal services, and the public.

If you have any comments, questions, or suggestions regarding USPAP, please contact the ASB.

Appraisal Standards Board
The Appraisal Foundation
1155 15th Street, NW, Suite 1111
Washington, DC 20005
Phone: 202-347-7722
Fax: 202-347-7727
E-Mail: info@appraisalfoundation.org
www.appraisalfoundation.org

TABLE OF CONTENTS

USPAP ADVISORY OPINIONS

Each Advisory Opinion is labeled as to its applicability to the various appraisal disciplines. The abbreviations are:

- Real Property – RP
- Personal Property – PP
- Intangible Property – IP (includes business interests)
- All disciplines – ALL

AO-1	Sales History	A-1
AO-2	Inspection of Subject Property	A-4
AO-3	Update of a Prior Appraisal.....	A-7
AO-4	Standards Rule 1-5(b)	A-10
AO-5	Assistance in the Preparation of an Appraisal.....	A-11
AO-6	The Appraisal Review Function.....	A-12
AO-7	Marketing Time Opinions.....	A-13
AO-8	Market Value vs. Fair Value in Real Property Appraisals	A-15
AO-9	The Appraisal of Real Property That May Be Impacted by Environmental Contamination.....	A-16
AO-10	The Appraiser-Client Relationship.....	A-21
AO-11	Content of the Appraisal Report Options of Standards Rules 2-2 and 8-2.....	A-22
AO-12	Use of the Appraisal Report Options of Standards Rules 2-2 and 8-2	A-27
AO-13	Performing Evaluations of Real Property Collateral to Conform with USPAP	A-29
AO-14	Appraisals for Subsidized Housing.....	A-30
AO-15	Using the DEPARTURE RULE in Developing a Limited Appraisal	A-33
AO-16	Fair Housing Laws and Appraisal Report Content.....	A-34
AO-17	Appraisals of Real Property with Proposed Improvements.....	A-37
AO-18	Use of an Automated Valuation Model (AVM).....	A-42
AO-19	Unacceptable Assignment Conditions in Real Property Appraisal Assignments.....	A-49
AO-20	An Appraisal Review Assignment That Includes the Reviewer’s Own Opinion of Value	A-54
AO-21	USPAP Compliance	A-61
AO-22	Scope of Work in Market Value Appraisal Assignments, Real Property.....	A-70
AO-23	Identifying the Relevant Characteristics of the Subject Property of a Real Property Appraisal Assignment.....	A-77
AO-24	Normal Course of Business.....	A-81
AO-25	Clarification of the Client in a Federally Related Transaction.....	A-84
AO-26	Readdressing (Transferring) a Report to Another Party.....	A-86
AO-27	Appraising the Same Property for a New Client	A-88
AO-28	Scope of Work Decision, Performance, and Disclosure	A-92
AO-29	An Acceptable Scope of Work.....	A-96
AO-30	Appraisals for Use by a Federally Regulated Financial Institution.....	A-99
AO-31	Assignments Involving More than One Appraiser.....	A-104
AO-32	Ad Valorem Property Tax Appraisal and Mass Appraisal Assignments.....	A-108

ADVISORY OPINION 1 (AO-1)

This communication by the Appraisal Standards Board (ASB) does not establish new standards or interpret existing standards. Advisory Opinions are issued to illustrate the applicability of appraisal standards in specific situations and to offer advice from the ASB for the resolution of appraisal issues and problems.

SUBJECT: Sales History

APPLICATION: Real Property

THE ISSUE:

The *Uniform Standards of Professional Appraisal Practice* (USPAP) contain sales history requirements that obligate appraisers of real property to analyze and report pending and recent agreements, options, listings, and sales involving the property being appraised. Because of differences in federal law and regulations, state laws and operating practices relating to the disclosure and confidentiality of real property sales data, the ways in which appraisers comply with the sales history requirements vary according to the jurisdiction and the availability of information. This lack of consistency has raised questions regarding the applicability and relevance of the sales history requirements.

How can the appraiser best comply with the sales history provisions of the applicable appraisal standards in the face of obstacles that are beyond the control of the appraiser?

ADVICE FROM THE ASB ON THE ISSUE:

Relevant USPAP & Advisory References

- Advisory Opinion 24 which addresses the “normal course of business.”

Analysis and Reporting Requirements

This Advisory Opinion offers advice and guidance for compliance with the requirements to analyze and report sales history and related information in the appraisal of real property.

USPAP Standards Rules 1-5(a) and (b) require an appraiser, when the value opinion to be developed is market value, and if such information is available to the appraiser in the normal course of business, to analyze (1) all agreements of sale, options, or listings of the subject property current as of the effective date of the appraisal and (2) all sales of the subject property that occurred within three (3) years prior to the effective date of the appraisal. USPAP Standards Rules 2-2(a)(viii), (b)(viii), and (c)(viii) call for the written appraisal report to contain sufficient information to indicate compliance with the sales history requirement. Standards Rules 2-2(a)(viii), (b)(viii), and (c)(viii) further require that, if sales history information is unobtainable, the written appraisal report must include a commentary on the efforts taken by the appraiser to obtain the information.

Laws, regulations and guidelines issued by government agencies, or government sponsored enterprises, also contain requirements that require the appraiser to analyze and report sales history information, and these requirements vary according to jurisdiction.

The requirement for the appraiser to analyze and report sales history and related information is fundamental to the appraisal process. Just as the appraiser must analyze pending and recent sales of comparable properties, the appraiser must take into account all pending and recent sales of the subject property itself. This is not to say that the agreed price in a pending or recent sale of the subject property is necessarily representative of value as defined in the report, but the appraiser’s failure to analyze and report these facts may exclude important information from the sales comparison approach. Information pertaining to the current market status and the

ADVISORY OPINION 1

40 sales history of the subject property may also be useful information for the determination of highest and best use
41 or the analysis of market trends.

Sample Sales Histories

43 The following sample sales histories are offered as examples of information that might be included in an
44 appraisal report in compliance with the applicable standards.

45 For a property that is not under agreement or option, that is not offered for sale on the open market and that has
46 not changed hands within the past three years, the sales history might be shown in the appraisal report as
47 follows:

48 Research of the applicable public records, private data services and an interview of the current owner,
49 revealed that the subject property is not under current agreement or option and is not offered for sale
50 on the open market. Additionally, according to these sources, the subject property has not been
51 transferred during the past three years.

52 For a property that is offered for sale on the open market and that was acquired by the current owner during the
53 past three years, the sales history to be included in the appraisal report might appear as follows.

54 The subject property is currently offered for sale at a listing price of \$XXX,XXX. A copy of the listing
55 agreement with Mary Smith, real estate broker, is included in the addendum to this report.

56 The subject property was sold by John Jones to the current owner on June 1, 20XX, for a reported
57 price of \$XXX,XXX. The parties to the transaction have affirmed that the seller received all cash and
58 that the reported price was unaffected by special or creative financing or sales concessions granted by
59 anyone associated with the sale. This sale is analyzed in the Sales Comparison Approach section of the
60 appraisal report.

61 According to the public records, there have been no other transfers of the subject property within the
62 past three years.

Sample Comments

64 The following sample comments are offered as examples of comments that might be included in an appraisal
65 report in cases where pertinent information is not available to the appraiser in the normal course of business.
66 The comments are fictitious and are offered only for purposes of illustration.

67 In cases where the property being appraised is known to be the subject of a pending transaction, but the
68 appraiser is not privy to the terms of the pending transaction and the parties to the transaction have declined to
69 disclose the terms of the transaction to the appraiser, the sales history to be included in the appraisal report
70 might include a comment such as the one shown below.

71 The property being appraised is known to be the subject of a pending purchase and sale agreement, but
72 the appraiser was unable to obtain the terms of the agreement. The current owner confirmed that the
73 property is under agreement but declined to disclose the terms of the agreement or to discuss the nature
74 of the agreement.

75 In jurisdictions where reliable price information cannot be found in the public records and where the appraiser
76 is unable to obtain complete information in the normal course of business, it would be appropriate to include in
77 the appraisal report a comment similar to the one shown below.

78 The subject property was sold by John Jones to the current owner on June 1, 20XX, for an unknown
79 price. The appraiser attempted to obtain the purchase price and other terms of the transaction without
80 success. The parties to the transaction declined to discuss the terms or conditions of the sale.

81 According to the public records, there have been no other transfers of the subject property within the
82 past three years.

ADVISORY OPINION 2

1 **ADVISORY OPINION 2 (AO-2)**

2 *This communication by the Appraisal Standards Board (ASB) does not establish new standards or interpret*
3 *existing standards. Advisory Opinions are issued to illustrate the applicability of appraisal standards in specific*
4 *situations and to offer advice from the ASB for the resolution of appraisal issues and problems.*

5 **SUBJECT: Inspection of Subject Property**

6 **APPLICATION: Real Property, Personal Property**

7 **THE ISSUE:**

8 For real property and personal property appraisal assignments, USPAP requires the report to contain a
9 certification indicating whether or not the subject property was personally inspected by the appraiser(s).

- 10 • What is the purpose of inspecting the subject property?
- 11 • Does USPAP mandate a minimum level of property inspection?
- 12 • What are the disclosure obligations relating to inspection?

13 **ADVICE FROM THE ASB ON THE ISSUE**

14 **Purpose of an Inspection**

15 The primary reason for inspection of a property is to gather information about the characteristics of the property
16 that are *relevant* to its value.¹

17 While there are other ways to gather such information, in many cases the personal observations of the appraiser
18 are the primary source of information regarding the subject property.

19 **Minimum Level of Inspection**

20 An inspection is not required by USPAP, but one is often conducted. While an inspection is not required,
21 appraisal reports for real and personal property must contain a signed certification which clearly states whether
22 the appraiser has or has not personally inspected the subject property. This is further discussed under the
23 Disclosure Requirements section which follows.

24 The extent of the inspection process is an aspect of the scope of work, and may vary based on assignment
25 conditions and the intended use of the assignment results.² It is the appraiser's responsibility to determine the
26 appropriate scope of work, including the degree of inspection necessary to produce credible assignment results
27 given the intended use.

28 Every assignment is subject to conditions that limit, in one way or another, the inspection of the subject
29 property. Regardless of the detail one employs, it is always possible to perform an inspection that is more
30 thorough. The appraiser's inspection commonly is limited to those things readily observable without the use of
31 special testing or equipment.

32 An appraiser may use any combination of property inspection, plans and specifications, asset records,
33 photographs, property sketches, recorded media, etc., to gather information about the relevant characteristics of

¹ See Advisory Opinion 23, *Identifying the Relevant Characteristics of the Subject Property of a Real Property Appraisal Assignment*.

² See Advisory Opinion 28, *Scope of Work Decision, Performance, and Disclosure*.

34 the subject property.³ For some assignments, it may be necessary to rely on reports prepared by other
 35 professionals. In such cases the appraiser must comply with USPAP requirements related to reliance on work
 36 done by others.

37 There are many circumstances that influence the extent of the appraiser’s property inspection. In some
 38 assignments, the client may request that the appraiser perform an exterior-only inspection from the street or
 39 perform no inspection of the subject property (i.e., a “desktop appraisal”). There are situations where inspection
 40 of the subject property is not possible; for example, if the improvements have been destroyed, removed, or not
 41 yet built. In other cases the appraiser is denied access to the property.

42 The appraiser must ensure that the degree of inspection is adequate to develop a credible appraisal. An appraiser
 43 cannot develop a credible appraisal if adequate information about the relevant characteristics of the subject
 44 property is not available. When adequate information about relevant characteristics is not available through a
 45 personal inspection or from sources the appraiser believes are reliable, an appraiser must withdraw from the
 46 assignment unless the appraiser can:

- 47 • modify the assignment conditions to expand the scope of work to include gathering the necessary
 48 information; or
- 49 • use an extraordinary assumption about such information, if credible assignment results can still be
 50 developed.

51 An inspection conducted by an appraiser is usually not the equivalent of an inspection by an inspection
 52 professional (e.g., a structural engineer, a licensed home inspector, a Renaissance art expert). An appraiser’s
 53 observations must, at the minimum, be thorough enough to properly develop the appraisal and adequately report
 54 the relevant characteristics. Regardless of how the information is gathered, it must be sufficient for the
 55 development of relevant analyses, such as highest and best use, the application of the approaches, etc.

56 **Disclosure Requirements**

57 Appraisal reports for real and personal property must contain a signed certification indicating whether the
 58 appraiser has or has not personally inspected the subject property. All appraisal reports must also contain
 59 sufficient information to enable the intended users to understand the extent of the inspection that was
 60 performed.

61 Because of the infinite variability of inspections, it is important that the appraisal report clearly communicates
 62 the degree of the inspection in order for the report to be meaningful.⁴

63 **Illustrations**

- 64 1. I have been asked to appraise a single-family home based on an exterior-only inspection from the street.
 65 What are my development and reporting obligations?

66 If an appraiser’s observations are limited to an exterior-only inspection from the street, then the
 67 appraiser must gather information on relevant characteristics from other data sources and/or use
 68 extraordinary assumptions.⁵ The data sources used are often the same sources used to gather
 69 information on comparable sales. For example, the size of the property might be obtained from public
 70 records, and other information might be obtained from interior photographs included in a listing of the
 71 property for sale, or information from the appraiser’s own files.

³ See Comment to Standards Rules 1-2(e) and 7-2(e).

⁴ See Standards Rules 2-2(a)(vii), 2-2(b)(vii), 2-2(c)(vii), 7-2(a)(vii), 7-2(b)(vii) and 7-2(c)(vii).

⁵ See Standards Rules 2-2(a)(x), 2-2(b)(x), 2-2(c)(x), 7-2(a)(x), 7-2(b)(x) and 7-2(c)(x).

ADVISORY OPINION 2

72 The report must disclose the extent of the property inspection in a manner that is clear to the intended
73 users. For example, in this case it would probably be insufficient to merely state that the property was
74 inspected. The report must make clear that the appraisal was based on an “exterior only” inspection
75 from the street and state the sources used to identify the relevant characteristics other than those
76 observed during the inspection.

77 2. A dealer has asked me to appraise a Rolex watch. I will not be provided access to the piece. However, I
78 have been given the serial number, a copy of an authenticity certificate and several recent photographs of
79 the watch. Can I develop an appraisal based solely on this information?

80 Yes, if the data provided contains sufficient information about the subject’s relevant characteristics, one
81 could develop an appraisal based on the information described in the illustration. Without directly
82 inspecting the watch, however, the information provided is “assumed” to be accurate. Because some of
83 these assumptions will have a significant effect on the assignment results, the assignment will involve
84 the use of extraordinary assumptions and require proper disclosure. The scope of work in the
85 assignment, including the degree of the inspection, must provide results that are credible in the context
86 of the intended use.⁶

87 3. I have been contacted by a property owner who is being transferred by his company to another city. The
88 owner indicated that while he might want a “detailed appraisal” later, right now he only needs a rough idea
89 of the value of the residence to begin negotiations related to the relocation. The owner has asked me to
90 perform a “desktop” appraisal (i.e., an appraisal with no inspection of the property). I believe that, given
91 this intended use, credible assignment results can be developed without an inspection. Is this permitted
92 under USPAP?

93 Yes, this is permitted if sufficient information regarding the relevant characteristics of the property is
94 available. Such information could be obtained from public records, previous listings of the property
95 for sale, appraiser’s files, etc. If use of extraordinary assumptions related to various relevant
96 characteristics is necessary, then one must comply with the requirements for their use.

⁶ See SCOPE OF WORK RULE.

ADVISORY OPINION 3 (AO-3)

This communication by the Appraisal Standards Board (ASB) does not establish new standards or interpret existing standards. Advisory Opinions are issued to illustrate the applicability of appraisal standards in specific situations and to offer advice from the ASB for the resolution of appraisal issues and problems.

SUBJECT: Update of a Prior Appraisal

APPLICATION: Real Property, Personal Property, Intangible Property

THE ISSUE:

Once an appraisal of a property, or an appraisal consulting assignment, has been completed, there are many cases in which a client may need a subsequent appraisal or analysis involving the same property. Examples include:

- In the appraisal of real property, a current value is commonly required by lenders and secondary market participants when the time frame between the effective date of a prior appraisal and the closing of a loan exceeds certain limits. A current value is also required by agencies in eminent domain cases when time has elapsed between a prior appraisal and the date of taking.
- In the appraisal of business equity of privately held companies held by Employee Stock Ownership Trusts, current values are required at least annually.
- In the appraisal of personal property, it may be necessary to appraise equipment every two years for financing purposes.
- Similarly, a client may request an update of a prior appraisal consulting assignment, or a review assignment that included the reviewer’s opinion of value.

Clients sometimes label such requests as “updates,” “reappraisals,” or “recertifications.” Does USPAP address these and how can an appraiser comply with USPAP for such assignments?

ADVICE FROM THE ASB ON THE ISSUE:

Clarification of Terminology

Various terms have been developed by clients and client groups for certain appraisal assignments, including “updates” and “recertifications”. While such terms may be convenient for use in a business setting, they do not necessarily impart the same meaning in every situation.

The term “Update” is often used by clients when they are seeking a current appraisal of a property that was the subject of a prior assignment. This practice is addressed in this Advisory Opinion.

The term “Recertification of Value” is often mistakenly used by some clients in lieu of the term “Update.” A Recertification of Value is performed to confirm whether or not the conditions of a prior appraisal have been met. A Recertification of Value does not change the effective date of the value opinion. If a client uses this term in an assignment request that includes an updated value opinion, then it constitutes a new appraisal assignment that must be completed as discussed in this Advisory Opinion.

ADVISORY OPINION 3

A New Assignment of a Prior Assignment

36 Regardless of the nomenclature used, when a client seeks a more current value or analysis of a property that was
37 the subject of a prior assignment, this is not an *extension* of that prior assignment that was already completed –
38 it is simply a new assignment. An “assignment” is defined in USPAP as:

39 *1) An agreement between an appraiser and a client to provide a valuation service; 2) the valuation*
40 *service that is provided as a consequence of such an agreement.*

41 The same USPAP requirements apply when appraising or analyzing a property that was the subject of a prior
42 assignment. There are no restrictions on who the appraiser is in such a circumstance, who the client is¹, what
43 length of time may have elapsed between the prior and current assignments, or whether the characteristics of the
44 subject property are unchanged or significantly different than in the prior assignment.

Development Requirements

46 For all assignments, the development of the assignment results must be in accordance with the requirements
47 contained in the applicable STANDARD (1, 3, 4, 6, 7, or 9). When developing an opinion regarding a property
48 that was the subject of a previous assignment, the scope of work in the new assignment may be different from
49 the scope of work in the prior one. In addition, rather than duplicating steps in the appraisal process, the
50 appraiser can elect to incorporate some of the analyses from the previous assignment (those items that the
51 appraiser concludes are credible and in compliance with the applicable development Standard) into the new
52 assignment through the use of an extraordinary assumption.

Reporting Requirements

54 For all assignments, the results must be reported in accordance with the requirements of STANDARDS 2, 3, 5,
55 6, 8, or 10, as applicable. The new report is not required to have the same level of detail as the original report –
56 i.e., a different reporting option may be used. However, the new report must contain sufficient information to
57 be meaningful and not misleading to the intended users. There are three ways that the reporting requirements
58 can be satisfied for these types of assignments:

- 59 1. Provide a new report that contains all the necessary information/analysis to satisfy the applicable
60 reporting requirements, *without incorporation* of the prior report by either attachment or reference.
- 61 2. Provide a new report that *incorporates by attachment* specified information/analysis from the prior
62 report so that, in combination, the attached portions and the new information/analysis added satisfies
63 the applicable reporting requirements.
- 64 3. Provide a new report that *incorporates by reference* specified information/analysis from the prior
65 report so that, in combination, the referenced portions and the new information/analysis added satisfies
66 the applicable reporting requirements. This option can only be used if the original appraiser’s firm and
67 original intended users are involved, since the prior report was issued from that appraiser to those
68 intended users, assuring they have access to a copy. When this incorporation by reference option is
69 used, the following items from that prior report must be specifically identified in the new report to
70 avoid being misleading:
 - 71 • subject property
 - 72 • client and any other intended users
 - 73 • intended use
 - 74 • appraiser(s)

¹ See Advisory Opinion 27, *Appraising the Same Property for a New Client*.

- 75 • effective date of value or assignment results
76 • date of report, and
77 • interest(s) appraised

78 When information is being extended to the report by use of an extraordinary assumption, the requirements in
79 USPAP for use of an extraordinary assumption must be met.

80 **Confidentiality**

81 In all assignments the appraiser must comply with the Confidentiality section of the ETHICS RULE with
82 respect to the handling of confidential information – i.e., if the prior appraisal, appraisal review, or appraisal
83 consulting report included any confidential information, its disclosure in a new report to a different client or
84 intended user might violate the ETHICS RULE. This includes the requirement to comply with *all*
85 *confidentiality and privacy laws and regulations.*

86 **Record Keeping**

87 If the assignment includes use of, or reliance upon, all or part of a prior report, that report (or the portions used
88 or relied upon) must be retained in the workfile for the new assignment, or its location must be properly
89 referenced in the workfile. Refer to the RECORD KEEPING RULE for more information.

ADVISORY OPINION 4

1 **ADVISORY OPINION 4 (AO-4)**

2 *This communication by the Appraisal Standards Board (ASB) does not establish new standards or interpret*
3 *existing standards. Advisory Opinions are issued to illustrate the applicability of appraisal standards in specific*
4 *situations and to offer advice from the ASB for the resolution of appraisal issues and problems.*

5 **SUBJECT: Standards Rule 1-5(b)**

6 **APPLICATION: Real Property**

7 **THE ISSUE:**

8 In developing a real property appraisal, Standards Rule 1-5(b) requires an appraiser to analyze all sales of the
9 subject property being appraised that occurred within three (3) years prior to the effective date of the appraisal.
10 Must a transfer of title in lieu of foreclosure or a foreclosure sale be analyzed?

11 **ADVICE FROM THE ASB ON THE ISSUE:**

12 The intent of Standards Rule 1-5(b) is to encourage the research and analysis of prior sales of the subject
13 property. All sales of the appraised property within the 3-year time period stated in Standards Rule 1-5(b)
14 includes transfers in lieu of foreclosure and foreclosure sales.

15 Foreclosure sales and voluntary transfers of title by mortgagor to mortgagee in lieu of foreclosure are
16 transactions grounded in objective necessity. Nevertheless, they are sales because they transfer ownership of
17 and title to property for a valuable consideration. With research and analysis, an appraiser would be able to
18 report under STANDARD 2 that a prior sale of the subject property is influenced by undue stimulation or that
19 the sale does not reflect typical buyer and seller motivation.

1 **ADVISORY OPINION 5 (AO-5)**

2 **SUBJECT: Assistance in the Preparation of an Appraisal**

3 This Advisory Opinion has been retired by action of the Appraisal Standards Board.

4 Please refer to Advisory Opinion 31, *Assignments Involving More Than One Appraiser* for related advice.

ADVISORY OPINION 6

1 **ADVISORY OPINION 6 (AO-6)**

2 **SUBJECT: The Appraisal Review Function**

3 This Advisory Opinion has been retired by action of the Appraisal Standards Board.

4 Please refer to Advisory Opinion 20, *An Appraisal Review Assignment That Includes the Reviewer's Own*
5 *Opinion of Value* and Advisory Opinion 21, *USPAP Compliance* for related advice.

ADVISORY OPINION 7 (AO-7)

This communication by the Appraisal Standards Board (ASB) does not establish new standards or interpret existing standards. Advisory Opinions are issued to illustrate the applicability of appraisal standards in specific situations and to offer advice from the ASB for the resolution of appraisal issues and problems.

SUBJECT: Marketing Time Opinions

APPLICATION: Real Property, Personal Property

THE ISSUE:

The *Uniform Standards of Professional Appraisal Practice* recognizes that some assignment conditions require the appraiser to analyze and report a reasonable marketing period for the subject property when developing and reporting an opinion of market value of real or personal property.

How is this reasonable marketing period opinion developed, and what is the relationship of this opinion of marketing time to the appraisal process?

ADVICE FROM THE ASB ON THE ISSUE:

The reasonable marketing time is an opinion of the amount of time it might take to sell a real or personal property interest at the concluded market value level during the period immediately after the effective date of an appraisal.

Marketing time differs from exposure time, which is always presumed to precede the effective date of an appraisal.¹

Rationale and Method for Developing a Marketing Time Opinion

The development of a marketing time opinion uses some of the same data analyzed in the process of developing a reasonable exposure time opinion as part of the appraisal process and is not intended to be a prediction of a date of sale or a one-line statement. It is an integral part of the analyses conducted during the appraisal assignment. The opinion may be a range and can be based on one or more of the following:

- statistical information about days on market,
- information gathered through sales verification,
- interviews of market participants, and
- anticipated changes in market conditions.

Related information garnered through this process includes other market conditions that may affect marketing time, such as the identification of typical buyers and sellers for the type of real or personal property involved and typical equity investment levels and/or financing terms. The reasonable marketing time is a function of price, time, use, and anticipated market conditions, such as changes in the cost and availability of funds, and is not an isolated opinion of time alone.

¹ See Statement on Appraisal Standards No. 6, *Reasonable Exposure Time in Real Property and Personal Property Opinions of Value*.

Discussion of Marketing Time in the Appraisal Report

33 Marketing time occurs after the effective date of the market value opinion and the marketing time opinion is
34 related to, yet apart from, the appraisal process. Therefore, it is appropriate for the section of the appraisal report
35 that discusses marketing time and its implications to appear toward the end of the report after the market value
36 conclusion. The request to provide a reasonable marketing time opinion exceeds the normal information
37 required for the appraisal process and should be treated separately from that process.

38 It is also appropriate for the appraiser to discuss the impact of price/value relationships on marketing time and
39 to contrast different potential prices and their associated marketing times with an appraiser's market value
40 opinion for the subject property.

41 **Applications to Client Uses of an Appraisal**

42 Clients concerned with marketing real or personal properties who obtain a market value appraisal as part of
43 their decision-making process should be aware that it may be inappropriate to assume that the value remains
44 stable during the marketing period. Therefore, it is technically incorrect for the user of an appraisal to take a
45 current value opinion, carry it forward to the end of a concluded marketing period, and then discount back to the
46 present.

47 Some clients attempt to solve their problem by ordering a "120-day market value," a "six-month market value,"
48 or a "one-year market value" from the appraiser. Unless the opinion of reasonable exposure time made by the
49 appraiser in the course of such an assignment coincides with the precondition imposed by the client, the answer
50 to this assignment cannot be stated as market value under a typical definition of the term. In such situations, the
51 appraiser must clearly distinguish between a market value opinion allowing for reasonable exposure time and
52 any alternative, appropriately defined, value opinion(s) subject to a special limiting condition resulting from the
53 client-imposed marketing time.

54 Whether or not the appraiser and client define the appraisal problem to include more than one opinion of market
55 value, the roles of the parties must be kept clear. The appraiser provides the client with a supported opinion of
56 defined value in an appropriately documented report that includes a section on reasonable marketing time and
57 any inherent price/value implications. The ultimate decision on issues like what price to ask, when to accept a
58 particular offering price, and how to account for the asset during the interim rests with the client.

1 **ADVISORY OPINION 8 (AO-8)**

2 **SUBJECT: Market Value vs. Fair Value in Real Property Appraisals**

3 This Advisory Opinion has been retired by action of the Appraisal Standards Board.

ADVISORY OPINION 9

1 ADVISORY OPINION 9 (AO-9)

2 *This communication by the Appraisal Standards Board (ASB) does not establish new standards or interpret*
3 *existing standards. Advisory Opinions are issued to illustrate the applicability of appraisal standards in specific*
4 *situations and to offer advice from the ASB for the resolution of appraisal issues and problems.*

5 **SUBJECT: The Appraisal of Real Property That May Be Impacted by Environmental Contamination**

6 **APPLICATION: Real Property**

7 **THE ISSUE:**

8 Appraisals of contaminated properties, or properties suspected of being contaminated, are sometimes developed
9 using either a hypothetical condition or an extraordinary assumption that the property is free of the
10 contamination. While this is acceptable practice under certain conditions and for certain intended uses, there are
11 assignments that require an appraisal of the “as-is” condition of the property, with full consideration of the
12 effects of environmental contamination. In these assignments, the appraiser is asked to analyze the effects of
13 known environmental contamination on the value of the subject property.

14 How does an appraiser comply with USPAP when appraising properties that may be impacted by environmental
15 contamination?

16 **ADVICE FROM THE ASB ON THE ISSUE:**

17 Relevant USPAP & Advisory References

- 18
- DEFINITIONS, specifically the definitions of

19 *Extraordinary Assumption: an assumption, directly related to a specific assignment, as of the*
20 *effective date of the assignment results, which, if found to be false, could alter the appraiser’s*
21 *opinions or conclusions.*

22 *Comment: Extraordinary assumptions presume as fact otherwise uncertain information about*
23 *physical, legal, or economic characteristics of the subject property; or about conditions*
24 *external to the property, such as market conditions or trends; or about the integrity of data*
25 *used in an analysis.*

26 *Hypothetical Condition: a condition, directly related to a specific assignment, which is contrary to*
27 *what is known by the appraiser to exist on the effective date of the assignment results, but is used*
28 *for the purpose of analysis. .*

29 *Comment: Hypothetical conditions are contrary to known facts about physical, legal, or*
30 *economic characteristics of the subject property; or about conditions external to the property,*
31 *such as market conditions or trends; or about the integrity of data used in an analysis.*

- 32
- ETHICS RULE, particularly
33 *Conduct: An appraiser must perform assignments with impartiality, objectivity, and*
34 *independence, and without accommodation of personal interests An appraiser must not*
35 *communicate assignment results with the intent to mislead or to defraud.*
 - COMPETENCY RULE, *An appraiser must: (1) be competent to perform the assignment; (2)*
36 *acquire the necessary competency to perform the assignment; or (3) decline or withdraw from the*
37 *assignment.*
38
39

- 40 • Standards Rule 1-1(a): *In developing a real property appraisal, an appraiser must: (a) be aware*
 41 *of, understand, and correctly employ those recognized methods and techniques that are necessary*
 42 *to produce a credible appraisal;*
- 43 • Standards Rule 1-2(e): *In developing a real property appraisal, an appraiser must: (e) identify the*
 44 *characteristics of the property that are relevant to the type and definition of value and intended*
 45 *use of the appraisal....*
- 46 • Standards Rule 1-2(f) and (g): *In developing a real property appraisal, an appraiser must: (f)*
 47 *identify any extraordinary assumptions necessary in the assignment; and (g) identify any*
 48 *hypothetical conditions necessary in the assignment.*
- 49 • Standards Rule 1-3(b): *When necessary for credible assignment results in developing a market*
 50 *value opinion, an appraiser must: (b) develop an opinion of the highest and best use of the real*
 51 *estate.*
- 52 • Standards Rule 1-4: *In developing a real property appraisal, an appraiser must collect, verify,*
 53 *and analyze all information necessary for credible assignment results.*

54 Competency and Related Issues

55 Consistent with Standards Rule 1-1(a): in the appraisal of a property as impacted by environmental
56 contamination, an appraiser must *be aware of, understand, and correctly employ those recognized methods and*
57 *techniques necessary to produce a credible appraisal*. Accordingly, an appraiser must have the requisite
58 knowledge about appropriate methods, and be able to assemble the required information. An appraiser who
59 lacks knowledge and experience in analyzing the impact of environmental contamination on the value of real
60 property must take the steps necessary to complete the assignment competently, as required by the
61 COMPETENCY RULE. However, an appraiser need not be an expert on the scientific aspects of environmental
62 contamination, and in most situations the appraiser will utilize scientific and other technical data prepared by
63 others, such as environmental engineers. In these situations, the appraiser should utilize an extraordinary
64 assumption [see Standards Rule 1-2(f)] regarding the information obtained from other experts that is used in the
65 appraisal. Examples of such information include items (1) to (10) under the header titled “Relevant Property
66 Characteristics” later in this Advisory Opinion. This is especially important in situations where there is
67 conflicting information about such information.

68 Specialized Terms and Definitions

69 The appraisal of properties that may be impacted by environmental contamination involves specialized terms
70 and definitions that might not be used in an appraisal assignment in which the effect of the property’s
71 environmental condition is not analyzed, or when the property is not contaminated. Though it is recognized that
72 there are other valid definitions of these and similar terms, for purposes of this Advisory Opinion, the following
73 definitions apply:

74 **Diminution in Value (Property Value Diminution):** The difference between the unimpaired and impaired
75 values of the property being appraised. This difference can be due to the increased risk and/or costs attributable
76 to the property’s environmental condition.

77 **Environmental Contamination:** Adverse environmental conditions resulting from the release of hazardous
78 substances into the air, surface water, groundwater or soil. Generally, the concentrations of these substances
79 would exceed regulatory limits established by the appropriate federal, state, and/or local agencies.

80 **Environmental Risk:** The additional or incremental risk of investing in, financing, buying and/or owning
81 property attributable to its environmental condition. This risk is derived from perceived uncertainties
82 concerning:

- 83 1) the nature and extent of the contamination;
- 84 2) estimates of future remediation costs and their timing;
- 85 3) potential for changes in regulatory requirements;
- 86 4) liabilities for cleanup (buyer, seller, third party);
- 87 5) potential for off-site impacts; and
- 88 6) other environmental risk factors, as may be relevant.

89 **Environmental Stigma:** An adverse effect on property value produced by the market’s perception of increased
90 environmental risk due to contamination. (See Environmental Risk)

91 **Impaired Value:** The market value of the property being appraised with full consideration of the effects of its
92 environmental condition and the presence of environmental contamination on, adjacent to, or proximate to the
93 property. Conceptually, this could be considered the “as-is” value of a contaminated property.

94 **Remediation Cost:** The cost to cleanup (or remediate) a contaminated property to the appropriate regulatory
95 standards. These costs can be for the cleanup of on-site contamination as well as mitigation of off-site impacts
96 due to migrating contamination.

97 **Remediation Lifecycle:** A cycle consisting of three stages of cleanup of a contaminated site: before
 98 remediation or cleanup; during remediation; and after remediation. A contaminated property's remediation
 99 lifecycle stage is an important determinant of the risk associated with environmental contamination.
 100 Environmental risk can be expected to vary with the remediation lifecycle stage of the property.

101 **Source, Non-source, Adjacent and Proximate Sites:** Source sites are the sites on which contamination is, or
 102 has been, generated. Non-source sites are sites onto which contamination, generated from a source site, has
 103 migrated. An adjacent site is not contaminated, but shares a common property line with a source site. Proximate
 104 sites are not contaminated and not adjacent to a source site, but are in close proximity to the source site.

105 **Unimpaired Value:** The market value of a contaminated property developed under the hypothetical condition
 106 that the property is not contaminated.

107 **Relevant Property Characteristics**

108 The appraisal of a property that includes the effects of environmental contamination on its value usually
 109 requires data not typically used in an appraisal of an otherwise similar but uncontaminated property or an
 110 appraisal of a potentially impacted property using either a hypothetical condition or an extraordinary
 111 assumption that it is uncontaminated or not impacted. The inclusion of these additional relevant property
 112 characteristics is consistent with Standards Rule 1-2(e). The relevant property characteristics may include, but
 113 are not limited to:

- 114 1) whether the contamination discharge was accidental or permitted;
- 115 2) the status of the property with respect to regulatory compliance requirements;
- 116 3) the remediation lifecycle stage (before, during or after cleanup) of the property as of the appraisal date;
- 117 4) the contamination constituents (petroleum hydrocarbons, chlorinated solvents, etc.);
- 118 5) the contamination conveyance (air, groundwater, soil, etc.);
- 119 6) whether the property is a source, non-source, adjacent or proximate site;
- 120 7) the cost and timing of any site remediation plans;
- 121 8) liabilities and potential liabilities for site cleanup;
- 122 9) potential limitations on the use of the property due to the contamination and its remediation; and
- 123 10) potential or actual off-site impacts due to contaminant migration (for source sites).

124 Since the appraiser is usually not an expert on the scientific aspects of contamination, experts from other fields
 125 will typically provide this information. Appropriate regulatory authorities should also be consulted to confirm
 126 the presence or absence of contamination. The appraiser should consider the use of extraordinary assumptions
 127 when this information serves as a basis for an opinion of value. The appraiser should also collect similar data
 128 for any comparable sales used in the analysis.

129 **Valuation Issues – As If Unimpaired**

130 In some assignments, the appraiser may be asked to appraise a property known to be contaminated under the
 131 *hypothetical condition* that the real estate is free of contamination. In these assignments, an appraiser may
 132 appraise interests in real estate that is known to be contaminated under the hypothetical condition that the real
 133 estate is free of contamination when:

- 134 1) the resulting appraisal report is not misleading,
- 135 2) the client has been advised of the limitation, and
- 136 3) all the requirements of the ETHICS RULE have been satisfied.

ADVISORY OPINION 9

137 To avoid confusion in the marketplace, the appraiser should disclose available information about the
138 contamination problem, explain the purpose of the hypothetical condition that the real estate is not
139 contaminated, and state that the use of the hypothetical condition might have affected the assignment results in
140 accordance with SR 2-2(a), (b), and (c)(x).

141 In other situations, the appraiser may be asked to appraise a property believed to be free of contamination or for
142 which the environmental status is uncertain due to the lack of information or conflicting information. For these
143 assignments, the property may be appraised under the *extraordinary assumption* concerning assumed factual
144 information about its environmental condition and status. Indeed, since an appraiser is usually not an expert in
145 detecting contamination, or confirming its absence, extraordinary assumptions regarding environmental
146 condition may be necessary in many assignments.

147 **Valuation Issues - As Impaired**

148 Highest & Best Use Issues: The appraisal of properties that may be impacted by environmental contamination
149 usually involves extensive highest and best use analysis. In accordance with Standards Rules 1-2(e) and 1-3(b),
150 the appraiser must consider relevant factors in developing an opinion of the highest and best use of the property
151 in its impaired condition. The valuation of properties impacted by environmental contamination usually
152 involves the estimate of two values: the unimpaired value and the impaired. As such, two highest and best use
153 analyses are typically required. The first does not consider any limitations on the property due to the
154 environmental contamination. The second does consider any limitations due to the contamination, its
155 remediation, and any legal use restrictions associated with the cleanup of the contamination source.
156 Environmental contamination and its remediation to appropriate regulatory standards may affect the feasibility
157 of site development or redevelopment, use of the site during remediation, use of the site after remediation,
158 marketability of the site, and other economic and physical characteristics of a contaminated property. The
159 appraiser should consider the possibility that site remediation and any remaining limitations on the use of the
160 site following remediation may alter or limit its highest and best use in the impaired condition. In addition,
161 excessive environmental risk and stigma may deter site development or redevelopment and thereby limit the
162 highest and best use until the property's environmental risk is reduced to levels acceptable to the relevant
163 market participants.

164 Satisfying SR 1-4 Requirements: When the appraiser addresses the diminution in value of a contaminated
165 property and/or its impaired value, the appraiser must recognize that the value of an interest in impacted or
166 contaminated real estate may not be measurable simply by deducting the remediation or compliance cost
167 estimate from the opinion of the value as if unaffected (unimpaired value). Rather, *cost*, *use* and *risk* effects can
168 potentially impact the value of contaminated property. *Cost effects* primarily represent deductions for costs to
169 remediate a contaminated property. These costs are usually estimated by someone other than the appraiser, and
170 should include consideration of any increased operating costs due to property remediation. The appraiser should
171 also be aware that the market might not recognize all estimated costs as having an effect on value. *Use effects*
172 reflect impacts on the utility of the site as a result of the contamination. If the contamination and/or its cleanup
173 rendered a portion of the site unusable, or limited the future highest and best use of the property, then there
174 could be a use effect on value. *Risk effects* are typically estimated by the appraiser and often represent the most
175 challenging part of the appraisal assignment. These effects are derived from the market's perception of
176 increased environmental risk and uncertainty. The analysis of the effects of increased environmental risk and
177 uncertainty on property value (environmental stigma) must be based on market data, rather than unsupported
178 opinion or judgment.

179 In general, the unimpaired value of the property being appraised can be estimated using the sales comparison
180 approach [SR 1-4(a)], cost approach [SR 1-4(b)], and income approach [SR 1-4(c)]. Estimating the effects of
181 environmental contamination on real property value usually involves the application of one or more specialized
182 valuation methods. These methods should be consistent with the requirements related to the valuation
183 approaches in USPAP.

1 **ADVISORY OPINION 10 (AO-10)**

2 **SUBJECT: The Appraiser-Client Relationship**

3 This Advisory Opinion has been retired by action of the Appraisal Standards Board.

4 Please refer to Advisory Opinion 25, *Clarification of the Client in a Federally Related Transaction*, Advisory
5 Opinion 26, *Readdressing (Transferring) a Report to Another Party*, and Advisory Opinion 27, *Appraising the*
6 *Same Property for a New Client*, for related advice.

ADVISORY OPINION 11

1 ADVISORY OPINION 11 (AO-11)

2 *This communication by the Appraisal Standards Board (ASB) does not establish new standards or interpret*
3 *existing standards. Advisory Opinions are issued to illustrate the applicability of appraisal standards in specific*
4 *situations and to offer advice from the ASB for the resolution of appraisal issues and problems.*

5 **SUBJECT: Content of the Appraisal Report Options of Standards Rules 2-2 and 8-2¹**

6 **APPLICATION: Real Property, Personal Property**

7 **THE ISSUE:**

8 Standards Rules 2-2 and 8-2 of the *Uniform Standards of Professional Appraisal Practice* (USPAP) offer three
9 written appraisal report options. What information should be contained in each type of report?

10 **ADVICE FROM THE ASB ON THE ISSUE:**

11 **Relevant USPAP & Advisory References**

- 12 • Under Standards Rules 2-2 and 8-2, an appraiser may communicate the results of the appraisal in
13 one of three formats: Self-Contained Appraisal Report (Standards Rules 2-2(a) and 8-2(a),
14 Summary Appraisal Report (Standards Rules 2-2(b) and 8-2(b)), or Restricted Use Appraisal
15 Report (Standards Rules 2-2(c) and 8-2(c)). Standards Rules 2-2 and 8-2 require that the report
16 prominently state which option is used.
- 17 • The Comments to Standards Rules 2-2 and 8-2 state that *the essential difference among the three*
18 *options is in the content and level of information provided.*

19 **Prominent Statement of Option Used**

20 The prominent statement of which option was used is a label that indicates to the reader how the appraisal is
21 reported. Therefore, the statement should appear at or near the beginning of the report.

22 In narrative appraisal reports, the prominent statement of which report option is used could appear with the
23 statement of the intended use of the appraisal because the decision on which report option to use is primarily
24 related to the intended use of the appraisal. For added prominence, a statement of the report option used could
25 also appear on any cover page or transmittal letter, if part of the report.

26 In form appraisal reports, the prominent statement of which report option is used could appear in the margin at
27 the top of the front of the form.

28 **Content of the Self-Contained Appraisal Report**

29 The Self-Contained Appraisal Report should contain all information significant to the solution of the appraisal
30 problem. “Describe” is the distinguishing term related to the Self-Contained Appraisal Report.

31 Standards Rules 2-2(a)(vii) and 8-2(a)(vii) require a description of the scope of work used to develop the
32 appraisal. The intended users of the Self-Contained Appraisal Report should expect to find all significant data
33 reported in comprehensive detail.

¹ See Standards Rules 2-2 and 8-2. See also related Advisory Opinion 12, *Use of the Appraisal Report Options of Standards Rules 2-2 and 8-2.*

34 **Content of the Summary Appraisal Report**

35 As noted in the Comments to Standards Rules 2-2(b) and 8-2(b):

36 *The essential difference between the Self-Contained Appraisal Report and the Summary Appraisal*
 37 *Report is the level of detail of presentation.*

38 The Summary Appraisal Report should contain a summary of all information significant to the solution of the
 39 appraisal problem. “Summarize” is the distinguishing term related to the Summary Appraisal Report.

40 Standards Rules 2-2(b)(vii) and 8-2(b)(vii) require a summary of the scope of work used to develop the
 41 appraisal. The intended users of the Summary Appraisal Report should expect to find all significant data
 42 reported in tabular or abbreviated narrative formats.

43 **Content of the Restricted Use Appraisal Report**

44 As noted in the Comment to Standards Rules 2-2(c)(i) and 8-2(c)(i):

45 *The Restricted Use Appraisal Report is for client use only. Before entering into an agreement, the*
 46 *appraiser should establish with the client the situations where this type of report is to be used and*
 47 *should ensure that the client understands the restricted utility of the Restricted Use Appraisal Report.*

48 The Restricted Use Appraisal Report should contain a brief statement of information significant to the solution
 49 of the appraisal problem. “State” is the distinguishing term related to the Restricted Use Appraisal Report.

50 Standards Rules 2-2(c)(vii) and 8-2(c)(vii) requires the report to state the scope of work used to develop the
 51 appraisal. The contents of the workfile must be sufficient for the appraiser to produce a Summary Appraisal
 52 Report.

53 **Differences in the Appraisal Report Options**

54 Each of the appraisal report options has reporting rules that serve as a content outline. The reporting rules for
 55 the Self-Contained Appraisal Report are Standards Rules 2-2(a)(i)-(xi) and 8-2(a)(i)-(xi). The reporting rules
 56 for the Summary Appraisal Report are Standards Rules 2-2(b)(i)-(xi) and 8-2(b)(i)-(xi). The reporting rules for
 57 the Restricted Use Appraisal Report are Standards Rules 2-2(c)(i)-(xi) and 8-2 (c)(i)-(xi).

58 The chart on the following page displays a rule by rule comparison of the reporting rules for the three types of
 59 reports. Space does not permit inclusion of the Comment to the reporting rules in the chart. The Comments
 60 contain important distinctions that must be considered in the preparation of each type of appraisal report, and
 61 the reader of this Advisory Opinion should refer to the full text of Standards Rules 2-2 and 8-2.

ADVISORY OPINION 11

62 **STANDARDS RULES 2-2 AND 8-2 REPORT COMPARISON CHART:** The essential difference among
 63 the three options is in the use and application of the terms “describe,” “summarize,” and “state.” “Describe” is
 64 used to connote a comprehensive level of detail in the presentation of information. “Summarize” is used to
 65 connote a more concise presentation of information. “State” is used to connote the minimal presentation of
 66 information.

67	a) Self-Contained Appraisal Report	b) Summary Appraisal Report	c) Restricted Use Appraisal Report
68	i. state the identity of the client and any intended users, by name or type;	i. state the identity of the client and any intended users, by name or type;	i. state the identity of the client by name or type; and state a prominent use restriction that limits use of the report to the client and warns that the appraiser’s opinions and conclusions set forth in the report may not be understood properly without additional information in the appraiser’s workfile;
69			
70	ii. state the intended use of the appraisal;	ii. state the intended use of the appraisal;	ii. state the intended use of the appraisal;
71			
72	iii. describe information sufficient to identify the real estate or personal property involved in the appraisal, including the physical and economic property characteristics relevant to the assignment;	iii. summarize information sufficient to identify the real estate or personal property involved in the appraisal, including the physical and economic property characteristics relevant to the assignment;	iii. state information sufficient to identify the real estate or personal property involved in the appraisal;
73			
74	iv. state the property interest appraised;	iv. state the property interest appraised;	iv. state the property interest appraised;
75			
76	v. state the type and definition of value and cite the source of the definition;	v. state the type and definition of value and cite the source of the definition;	v. state the type of value, and cite the source of its definition;
77			
78	vi. state the effective date of the appraisal and the date of the report;	vi. state the effective date of the appraisal and the date of the report;	vi. state the effective date of the appraisal and the date of the report;
79			
80	vii. describe the scope of work used to develop the appraisal;	vii. summarize the scope of work used to develop the appraisal;	vii. state the scope of work used to develop the appraisal;
81			
82	viii. describe the information analyzed, the appraisal methods and techniques employed, and the reasoning that supports the analyses, opinions, and conclusions; exclusion of the sales comparison approach, cost approach, or income approach must be explained;	viii. summarize the information analyzed, the appraisal methods and techniques employed, and the reasoning that supports the analyses, opinions, and conclusions; exclusion of the sales comparison approach, cost approach, or income approach must be explained;	viii. state the appraisal methods and techniques employed, state the value opinion(s) and conclusion(s) reached and reference the workfile; exclusion of the sales comparison approach, cost approach, or income approach must be explained;
83			
84	ix. state the use of the property existing as of the date of value and the use of the real estate or personal property reflected in the appraisal; and, when an opinion of highest and best use or the appropriate market or market level was developed by the appraiser, describe the support and rationale for that opinion;	ix. state the use of the property existing as of the date of value and the use of the real estate or personal property reflected in the appraisal; and, when an opinion of highest and best use or the appropriate market or market level was developed by the appraiser, summarize the support and rationale for that opinion;	ix. state the use of the property existing as of the date of value and the use of the real estate or personal property reflected in the appraisal; and, when an opinion of highest and best use or the appropriate market or market level was developed by the appraiser, state that opinion;
85			
86	x. clearly and conspicuously state all extraordinary assumptions and hypothetical conditions; and that their use might have affected the assignment results; and	x. clearly and conspicuously state all extraordinary assumptions and hypothetical conditions; and that their use might have affected the assignment results; and	x. clearly and conspicuously state all extraordinary assumptions and hypothetical conditions; and that their use might have affected the assignment results; and
87			
88	xi. include a signed certification in accordance with Standards Rule 2-3 or 8-3.	xi. include a signed certification in accordance with Standards Rule 2-3 or 8-3.	xi. include a signed certification in accordance with Standards Rule 2-3 or 8-3.
89			
90			
91			
92			
93			
94			
95			
96			
97			
98			
99			
100			
101			
102			
103			
104			
105			
106			
107			
108			

Comments have not been included in this chart

109 **Examples of the Application of the Terms “Describe,” “Summarize,” and “State” in the Context of a Real**
 110 **Property Appraisal Report**

111 The following presentations of the zoning section of a commercial appraisal report are used to exemplify the
 112 content differences in the three appraisal report options. These examples show a relative illustration of depth
 113 and detail of presentation and are not intended to characterize the format for an entire appraisal report. The
 114 examples are not intended to imply that information on zoning is necessary in all appraisal reports.

115 **EXAMPLE OF “DESCRIBE”**

116 **Zoning**

117 The General Business B-4 zoning classification applies to the subject real estate. The purpose of the B-4 zone is
 118 to encourage local commercial development along arterial streets to serve the surrounding residential areas. The
 119 uses of B-4 zoning and yard and bulk regulations to the B-4 zone are described below.

120 **Principal Permitted Uses**

121 Banking facilities, houses of worship, public buildings and facilities, service establishments, sit-down
 122 restaurants serving patrons on the premises, and stores for the sale of goods at retail.

123 **Special Permit Uses**

124 Business and professional offices, manufacturing of goods sold on the premises, medical clinics, multifamily
 125 dwellings (sites in excess of 15,000 sq. ft.), and take-out restaurants (sites in excess of 25,000 sq. ft.).

126 **Yard and Bulk Regulations**

127	Minimum Requirements	Lot Area:	10,000 sq. ft.
128		Lot Width:	100 feet
129		Front Yard:	20 feet
130		Side Yards:	10 feet (each)
131		Rear Yard:	10 feet
132		Off-Street Parking (Stores):	4 spaces per 1,000 sq. ft. of sales area
133	Maximum Requirements	Building Coverage:	50% of lot area
134		Building Height:	2 stories or 20 feet

135 **Conclusion**

136 On the basis of a review of the zoning regulations and a discussion with John N. Forcer of the Anytown
 137 planning and zoning office, the existing use and subject improvements are in conformance with zoning.

138 **EXAMPLE OF “SUMMARIZE”**

139 **Zoning**

140 The General Business B-4 zoning classification applies. Its purpose is to encourage local commercial
 141 development of banking facilities, retail stores, and service establishments along arterial streets on minimum
 142 lots of 10,000 sq. ft. with a width of 100 feet. Building coverage is limited to 50% of the lot, and building height
 143 is limited to two stories or 20 feet. John N. Forcer of the Anytown planning and zoning office indicates that the
 144 existing use and subject improvements conform.

ADVISORY OPINION 11

145 **EXAMPLE OF “STATE”**

146 **Zoning**

147 General Business, B-4; existing use and subject improvements conform.

148 The purpose of the above examples is to show one view of the differences among the application of the terms
149 “describe,” “summarize,” and “state.” The examples should not be extended beyond this Advisory Opinion to
150 every section of an appraisal report.

151 **Varying Depth and Detail Within the Report Option Selected**

152 Standard Rules 2-2(a)(viii) and 8-2(a)(viii) and 2-2(b)(viii) and 8-2(b)(viii) use the words “describe” and
153 “summarize,” respectively, as the distinguishing verb, but they contain the identical Comment that each item
154 must be addressed in the depth and detail required by its significance to the appraisal. The overall depth and
155 detail of information presented to satisfy each Standards Rule, not the length of any specific item, determine the
156 proper application of the report option utilized.

157 This Advisory Opinion focuses on the content of the appraisal report options and should be read in conjunction
158 with Advisory Opinion 12, which focuses on the use of the appraisal report options of STANDARD 2 and
159 STANDARD 8.

ADVISORY OPINION 12 (AO-12)

This communication by the Appraisal Standards Board (ASB) does not establish new standards or interpret existing standards. Advisory Opinions are issued to illustrate the applicability of appraisal standards in specific situations and to offer advice from the ASB for the resolution of appraisal issues and problems.

SUBJECT: Use of the Appraisal Report Options of Standards Rules 2-2 and 8-2¹

APPLICATION: Real Property, Personal Property

THE ISSUE:

Standards Rules 2-2 and 8-2 of the *Uniform Standards of Professional Appraisal Practice* (USPAP) offer three written appraisal report options. What are appropriate circumstances for the use of these options?

ADVICE FROM THE ASB ON THE ISSUE:

Relevant USPAP & Advisory References

- Under Standards Rules 2-2 and 8-2, an appraiser may communicate the results of an appraisal in one of three formats: Self-Contained Appraisal Report (Standards Rules 2-2(a) and 8-2(a)), Summary Appraisal Report (Standards Rules 2-2(b) and 8-2(b)), or Restricted Use Appraisal Report (Standards Rules 2-2(c) and 8-2(c)).

Deciding Which Report Option to Use

As with other business decisions that involve the application of USPAP, the existence of appraisal report options implies a dialogue between the appraiser and the client to define the appraisal problem prior to reaching an agreement to perform an assignment. Part of that dialogue is a decision on which report option is appropriate for the assignment. This dialogue/decision process can be applied to a single assignment or to a series of assignments performed by an appraiser for the same client. In most situations, the client may decide which report option is appropriate for the assignment. The appraiser may agree to provide the report option suggested by the client as long as the report option is consistent with the intended use of the appraisal.

The decision between using a Self-Contained Appraisal Report and a Summary Appraisal Report is not absolute. The following factors should be considered by the appraiser and the client in deciding whether a Self-Contained Appraisal Report or a Summary Appraisal Report is appropriate:

- the intended use of the appraisal;
- that the appraiser and client understand the differences between the options; and
- whether the intended use of the appraisal warrants comprehensive or summary disclosure of the steps in, and information considered in, the appraisal process.

A decision to use the Restricted Use Appraisal Report is absolute because the minimum level of information required in a Restricted Use Appraisal Report is not designed to address the needs of any third-party users. When an appraiser uses the Restricted Use Appraisal Report option, a prominent notice to any reader must be provided. The prominent notice must warn any reader of the report that the appraiser’s opinions and conclusions set forth in the report may not be understood properly without the additional information in the appraiser’s workfile. The Restricted Use Appraisal Report may be useful when:

¹ See Standards Rules 2-2 and 8-2. See also related Advisory Opinion 11, *Content of the Appraisal Report Options of Standards Rules 2-2 and 8-2*.

ADVISORY OPINION 12

- 37 • the client is the only intended user of the appraiser's opinions and conclusions set forth in the
38 report;
- 39 • the client understands the limited utility of this option;
- 40 • the intended use of the appraisal warrants restricted disclosure about the appraisal process steps
41 completed in the assignment; and
- 42 • the client (the only intended user) does not need the level of information required in a Self-
43 Contained Appraisal Report or Summary Appraisal Report.

44 This Advisory Opinion focuses on the use of the appraisal report options and should be read in conjunction with
45 Advisory Opinion 11, which focuses on the content of the appraisal report options of STANDARDS 2 and 8.

1 **ADVISORY OPINION 13 (AO-13)**

2 *This communication by the Appraisal Standards Board (ASB) does not establish new standards or interpret*
3 *existing standards. Advisory Opinions are issued to illustrate the applicability of appraisal standards in specific*
4 *situations and to offer advice from the ASB for the resolution of appraisal issues and problems.*

5 **SUBJECT: Performing Evaluations of Real Property Collateral to Conform with USPAP**

6 **APPLICATION: Real Property**

7 **THE ISSUE:**

8 How can an appraiser operating under the *Uniform Standards of Professional Appraisal Practice* (USPAP)
9 develop an evaluation of real property collateral (evaluation)?

NOTE: The advice that had previously appeared in Advisory Opinion 13 (AO-13) was provided to assist appraisers in understanding and complying with the *Interagency Appraisal and Evaluation Guidelines* that had been issued on October 27, 1994.

Those guidelines were superseded by revised *Interagency Appraisal and Evaluation Guidelines* issued on December 2, 2010. As a result, the ASB will be working with the Interagency Work Group to update AO-13 to provide meaningful guidance on this more recent edition of the guidelines. The ASB intends to expose proposed revisions to AO-13 as soon as possible, and expects to issue an updated version of AO-13 prior to the effective date of the next edition of USPAP, on January 1, 2014.

In the interim, appraisers are urged to review the revised guidelines by clicking on the following link to The Appraisal Foundation website: <https://appraisalfoundation.sharefile.com/d/s9a321e73b1947af9>.

ADVISORY OPINION 14

1 **ADVISORY OPINION 14 (AO-14)**

2 *This communication by the Appraisal Standards Board (ASB) does not establish new standards or interpret*
3 *existing standards. Advisory Opinions are issued to illustrate the applicability of appraisal standards in specific*
4 *situations and to offer advice from the ASB for the resolution of appraisal issues and problems.*

5 **SUBJECT: Appraisals for Subsidized Housing**

6 **APPLICATION: Real Property**

7 **THE ISSUE:**

8 Preparation of appraisals for subsidized housing in compliance with the *Uniform Standards of Professional*
9 *Appraisal Practice* (USPAP) requires knowledge and experience that goes beyond typical residential appraisal
10 competency. What guidance does USPAP provide for the appraisal of subsidized housing?

11 **ADVICE FROM THE ASB ON THE ISSUE:**

12 **Relevant USPAP & Advisory References**

- 13 • The COMPETENCY RULE states that “Competency requires: 1. the ability to identify the
14 problem to be addressed; and 2. the knowledge and experience to complete the assignment
15 competently.”
- 16 • The COMPETENCY RULE also requires “3. *recognition of, and compliance with, laws and*
17 *regulations that apply to the appraiser or to the assignment.*”
- 18 • The Comment to Standards Rule 1-1(a) states: *Important changes in the cost and manner of*
19 *constructing and marketing commercial, industrial, and residential real estate as well as changes*
20 *in the legal framework in which real property rights and interests are created, conveyed, and*
21 *mortgaged have resulted in corresponding changes in appraisal theory and practice. Social*
22 *change has also had an effect...*
- 23 • Standards Rule 1-2, particularly (a), (b), (c)(iv), (e) and (h); Standards Rule 1-3(a) and (b); and
24 Standards Rule 1-4(g).

25 **Identification of Subsidized Housing**

26 Subsidized housing may be defined as single- or multifamily residential real estate targeted for ownership or
27 occupancy by low- or moderate-income households as a result of public programs and other financial tools that
28 assist or subsidize the developer, purchaser, or tenant in exchange for restrictions on use and occupancy. The
29 United States Department of Housing and Urban Development (HUD) provides the primary definition of
30 income and asset eligibility standards for low- and moderate-income households. Other federal, state, and local
31 agencies define income eligibility standards for specific programs and developments under their jurisdictions.

32 **Competency Issues**

33 Appraisers should be aware that the competency required to appraise subsidized housing extends beyond typical
34 residential appraisal competency. Subsidized housing appraisals require the appraiser to understand the various
35 programs, definitions, and pertinent tax considerations involved in the particular assignment applicable to the
36 location and development. An appraiser should be capable of analyzing the impact of the programs and
37 definitions in the local subsidized housing submarket, as well as in the general market that is unaffected by
38 subsidized housing programs. Appraisers should also be aware of possible political changes that will affect the
39 durability of the benefits and restrictions to subsidized housing projects and fully understand interpretation and
40 enforcement of subsidy programs. An appraiser’s lack of knowledge and understanding of the impact of the
41 various influences that affect subsidized housing projects could lead to misleading conclusions. For example,

42 subsidized housing projects may have differences in income, expenses, and rates of returns when compared
 43 with unsubsidized housing projects. Appraisers should reflect the actions of the participants in the market and
 44 avoid any stereotyped or biased assumptions.

45 **Property Rights Issues**

46 Subsidies and incentives that encourage housing for low- and moderate-income households may create
 47 intangible property rights in addition to real property rights and may also create restrictions that modify real
 48 property rights. The appraiser should demonstrate the ability to discern the differences between the real and
 49 intangible property rights and value the various rights involved. Low-Income Housing Tax Credits (LIHTCs)
 50 are an example of an incentive that results in intangible property rights that are not real property but might be
 51 included in the appraisal. Project-based rent subsidies are an example of a subsidy accompanied by restrictions
 52 that modify real property rights. Appraisers should be aware that tenant-based rent subsidies do not
 53 automatically result in a property right to the owner or developer of subsidized housing.

54 Standards Rule 1-2(e) allows the inclusion of intangible assets that are not real property in the appraisal. *When*
 55 *personal property, trade fixtures, or intangible items are included in the appraisal, the appraiser must analyze*
 56 *the effect on value of such non-real property items, as required by Standards Rule 1-4(g).*

57 A critical factor in all subsidized housing appraisals is the analysis of whether or not the various subsidies,
 58 incentives, and restrictions remain with the real property following a sale or foreclosure and thus are marketable
 59 property rights to be included in the appraisal.

60 **Value Definition Issues**

61 The value definition in any appraisal is a controlling factor of the bundle of rights to be considered in the
 62 appraisal. Standards Rule 1-2(c) requires an appraiser to identify the type and definition of value. Standards
 63 Rule 1-2(c) further states, *if the value opinion to be developed is market value, ascertain whether the value is to*
 64 *be the most probable price:*

- 65 (i) *in terms of cash; or*
- 66 (ii) *in terms of financial arrangements equivalent to cash; or*
- 67 (iii) *in other precisely defined terms; and*
- 68 (iv) *if the opinion of value is to be based on non-market financing or financing with unusual*
 69 *conditions or incentives, the terms of such financing must be clearly identified and the*
 70 *appraiser's opinion of their contributions to or negative influence on value must be developed*
 71 *by analysis of relevant market data.*

72 If the appraisal of a subsidized housing assignment is for market value, the appraiser must determine if
 73 requirement (i), (ii), (iii), or (iv) above applies to the specific definition selected or required by the client. The
 74 appraiser can then determine if the programs and intangible assets created by the programs affecting the subject
 75 property qualify under the selected or required market value definition. This determination requires competent
 76 knowledge of the programs and whether the programs qualify under (i), (ii), (iii), or (iv) above.

77 USPAP does not mandate market value appraisals, but it does require that the type and definition of value be
 78 identified. If the type of value for the total property (real property and intangible assets) is not market value,
 79 then (i), (ii), (iii), and (iv) above may not be applicable.

80 In appraisal of subsidized housing, the value definition selected or required by the client and the reporting
 81 techniques used should be discussed with the client prior to the acceptance of the assignment because the
 82 analyses may be based on general market terms, subsidized housing submarket financing with unusual
 83 conditions or incentives, both, or some other defined premise.

ADVISORY OPINION 14

84 Because Standards Rule 1-2(c) also states that the terms of submarket financing or financing with unusual
85 conditions or incentives must be clearly set forth, their contributions to or negative influence on value must be
86 developed by analysis of relevant market data.

87 Subsidies and incentives should be explained in the appraisal report, and their effect on value, if any, needs to
88 be reported in conformity with STANDARD 2.

89 **Market Analysis Issues**

90 Certain specific steps should be taken when appraising subsidized property. Research with housing
91 organizations and public agencies should be completed to find appropriate data on financing, rental and
92 occupancy restrictions, resale restrictions, and sales of comparably subsidized or restricted properties.
93 Knowledge of the general markets and the subsidized housing submarkets should be evident in all analyses. The
94 market analyses should also address the subject's ability to attract a sufficient number of subsidized tenants.
95 Reversion projections should be based on interviews with market participants; any factual information from
96 developments that have reached the expiration of their subsidies, incentives, and restrictions; and other relevant
97 information.

- 1 **ADVISORY OPINION 15 (AO-15)**
- 2 **SUBJECT: Using the DEPARTURE RULE in Developing a Limited Appraisal**
- 3 This Advisory Opinion has been retired by action of the Appraisal Standards Board.

1 **ADVISORY OPINION 16 (AO-16)**

2 *This communication by the Appraisal Standards Board (ASB) does not establish new standards or interpret*
3 *existing standards. Advisory Opinions are issued to illustrate the applicability of appraisal standards in specific*
4 *situations and to offer advice from the ASB for the resolution of appraisal issues and problems.*

5 **SUBJECT: Fair Housing Laws and Appraisal Report Content**

6 **APPLICATION: Real Property**

7 **THE ISSUE:**

8 In developing and reporting an appraisal, appraisal review, or appraisal consulting assignment, what should an
9 appraiser consider to comply with current fair housing laws?

10 **BACKGROUND:**

11 Fair housing law(s) preclude the use of certain specific information or supported conclusions related to
12 protected group(s) in some assignments. Accordingly, an appraiser should be knowledgeable about the laws that
13 affect the subject property of an assignment. Laws and regulations on fair lending and fair housing (such as the
14 Fair Housing Act; the Equal Credit Opportunity Act (ECOA), and the laws and regulations of applicable
15 federal, state, and local jurisdictions) continue to evolve. Further, appraisers must continue to provide appraisals
16 that do not illegally discriminate or contribute to illegal discrimination. The Conduct section of the ETHICS
17 RULE states in part, *An appraiser must not use or rely on **unsupported** conclusions relating to characteristics*
18 *such as race, color, religion, national origin, gender, marital status, familial status, age, receipt of public*
19 *assistance income, handicap, or an **unsupported** conclusion that homogeneity of such characteristics is*
20 *necessary to maximize value* (bold added for emphasis).

21 In some cases, even **supported** conclusions in assignments relating to characteristics such as race, color,
22 religion, national origin, gender, marital status, familial status, age, receipt of public assistance income,
23 handicap, or group homogeneity cannot be used because they are precluded by applicable law.

24 **ADVICE FROM THE ASB ON THE ISSUE:**

25 **Relevant USPAP & Advisory References**

- 26
- 27 • The PREAMBLE states, *It is essential that appraisers develop and communicate their analyses,*
28 *opinions, and conclusions to intended users of their services in a manner that is meaningful and*
29 *not misleading.*
 - 30 • The Conduct section of the ETHICS RULE states:
31 *An appraiser must not engage in criminal conduct.*
32 *An appraiser must perform assignments with impartiality, objectivity, and independence, and*
33 *without accommodation of personal interests.*
34 **The COMPETENCY RULE states, ... An appraiser must: (1) be competent to perform the**
35 **assignment; (2) acquire the necessary competency to perform the assignment; or (3) decline or**
36 **withdraw from the assignment.**
 - 37 • *Competency requires: (1) the ability to properly identify the problem to be addressed; and (2) the*
38 *knowledge and experience to complete the assignment competently; and (3) recognition of, and*
39 *compliance with, laws and regulations that apply to the appraiser or to the assignment.*
 - 40 • The Comment to the COMPETENCY RULE states: *Competency may apply to factors such as, but*
41 *not limited to, an appraiser's familiarity with a specific type of property or asset, a market, a*
geographic area, an intended use, specific laws and regulations, or an analytical method.

- 42 • The Comment to Standards Rule 1-1(a) states, *Social change has also had an effect on appraisal*
 43 *theory and practice. To keep abreast of these changes and developments, the appraisal profession*
 44 *is constantly reviewing and revising appraisal methods and techniques and developing new*
 45 *methods and techniques to meet new circumstances. For this reason, it is not sufficient for*
 46 *appraisers to simply maintain the skills and knowledge they possess when they become*
 47 *appraisers. Each appraiser must continuously improve his or her skills to remain proficient in*
 48 *real property appraisal.*
- 49 • Standards Rule 2-1(a) states, *Each written or oral real property appraisal report must clearly and*
 50 *accurately set forth the appraisal in a manner that will not be misleading.*
- 51 • The content of the certification in Standards Rules 2-3, 3-3, 5-3 and 6-9 requires the following
 52 disclosures: *I certify that, to best of my knowledge and belief, ... the reported analyses, opinions,*
 53 *and conclusions are my personal, impartial, and unbiased professional analyses, opinions, and*
 54 *conclusions ...[and] my analyses, opinions, and conclusions were developed, and this report has*
 55 *been prepared, in conformity with the Uniform Standards of Professional Appraisal Practice.*
- 56 • The Conduct section of the ETHICS RULE states, *An appraiser must not use or rely on*
 57 *unsupported conclusions relating to characteristics such as race, color, religion, national origin,*
 58 *gender, marital status, familial status, age, receipt of public assistance income, handicap, or an*
 59 *unsupported conclusion that homogeneity of such characteristics is necessary to maximize value.*

60 **Appraisal Report Content**

61 An appraiser must ensure that his or her appraisal, appraisal review, or appraisal consulting opinions and
 62 conclusions are impartial and objective and do not illegally discriminate or contribute to illegal discrimination
 63 through subjective or stereotypical assumptions.

64 The use of terms or descriptive phrases in place of factual information in a report imposes particular obligations
 65 on an appraiser to ensure that the user properly understands the report and is not misled. An appraiser needs to
 66 have, and should report wherever possible and appropriate, factual information to support the use of terms or
 67 descriptive phrases that reflect a scale or rating of a market or property that affects value or marketability
 68 conclusions. If such factual information is absent, an appraiser should clearly disclose that the rating or
 69 descriptive phrase is the appraiser's opinion but that no factual information was available to support that rating
 70 or descriptive phrase and ensure that the use of the term or descriptive phrase is not illegally discriminatory.

71 An appraiser should research the actions of participants in the subject's market to identify factors having a
 72 direct favorable or unfavorable influence on marketability or value. Failure to extract pertinent market
 73 information (e.g., sales, rents, occupancy rates, expense ratios, capitalization or discount rates, construction
 74 costs, depreciation, or exposure times) from the subject's market could produce conclusions that are misleading
 75 and/or illegally discriminatory.

76 Appraisers should exercise care that comments made in a report will not be perceived as illegally biased or
 77 discriminatory. Factual descriptions, rather than subjective phrases, allow the user of a report to draw his or her
 78 own conclusions. The use of terms that reflect a scale such as "high," "low," "good," "fair," "poor," "strong,"
 79 "weak," "rapid," "slow," "average," or the like should also provide contextual information that properly
 80 explains the frame of reference and the relative position of the subject property on the scale. For example, if
 81 absorption is stated as "rapid," the context of the rating should be cited as well ("rapid" relative to what?).

82 **Competency**

83 Situations such as those listed below require specific research and competency to avoid the use of unsupported
84 conclusions:

- 85 • the property is designed to suit the needs of a protected group;
- 86 • there is little or no transaction information available on similar properties;
- 87 • the property is in a market setting where similar properties have not previously existed;
- 88 • market conditions are not similar to the conditions prevailing during the time frame in which
89 previous market transactions occurred; or
- 90 • there are financially subsidized rental or ownership programs.

91 **Illustrations:**

92 1. An appraiser is completing an assignment in an area where crime activity has recently been publicized.
93 The appraiser considers the use of the term “high-crime area.”

94 This is a subjective term that may be understood by the appraiser but may mislead the client. This
95 term does not provide the evidence that the appraiser used in making the observation. The
96 appraiser may provide a specific reference that is factual and objective (e.g., one crime per 100
97 people or one crime per 1,000,000 people) but may still mislead the client. If the appraiser is to be
98 competent with these types of statistics, the crime ratio should be correlated to the actions of the
99 market in reflecting a valuation adjustment or other indication of property demand. If all of the
100 comparables used by the appraiser are from a market sharing the same crime characteristic, the
101 appraiser should question whether the term and/or the statistic(s) are relevant to the appraisal
102 assignment.

103 2. A religious organization requests an appraiser to determine if a facility offering unique services to
104 specific religious members is feasible. The appraiser must research a geographic market and identify
105 concentrations of individuals that are members of that specific religion. Is the appraiser permitted to
106 complete the assignment under USPAP?

107 The assignment is not covered by ECOA or the Fair Housing Act. Under USPAP, the appraiser
108 must comply with the ETHICS RULE concerning discrimination.

109 The key in this case is not to use or rely on unsupported conclusions. If the appraiser can identify
110 the market behavior of the religious members and relate that behavior to the assignment, the
111 appraiser is not in violation of USPAP.

112 3. An appraiser is requested to review a portfolio of apartment appraisal reports in a market area where
113 apartments with public rent subsidies also exist. How does the Conduct section of the ETHICS RULE
114 affect the appraisal reviewer’s actions?

115 The review and conclusion of acceptance or rejection of the reports should not rely on the
116 appraisal reviewer’s unsupported conclusions regarding public assistance projects.

117 4. An appraiser is requested to appraise a house with specific features (e.g., ramps, wider doorways, and
118 special plumbing fixtures) designed to accommodate handicapped individuals. How does the appraiser
119 analyze the unique improvements?

120 The appraiser should reflect market preferences for the components of the structure. However, the
121 appraiser should not draw an unsupported conclusion that the fixtures either enhance or diminish
122 value.

ADVISORY OPINION 17 (AO-17)

This communication by the Appraisal Standards Board (ASB) does not establish new standards or interpret existing standards. Advisory Opinions are issued to illustrate the applicability of appraisal standards in specific situations and to offer advice from the ASB for the resolution of appraisal issues and problems.

SUBJECT: Appraisals of Real Property with Proposed Improvements**APPLICATION: Real Property****THE ISSUE:**

Can either a current or a prospective value opinion for a property subject to completion of proposed improvements be provided in compliance with the *Uniform Standards of Professional Appraisal Practice* (USPAP)?

BACKGROUND:

An appraisal of real property with proposed improvements presents complex analysis and reporting issues because some portion of the property appraised does not exist at the time of the appraisal. Consequently, an appraiser must use particular care when performing an appraisal of such property to ensure that the results are credible and the appraisal report is not misleading.

A client may have a legitimate need for either a current or a prospective opinion of value (or both) concerning proposed improvements to real property. This kind of appraisal may be performed for a variety of client types, such as lenders, developers, private investors, trusts, attorneys, government agencies, or insurance companies. Further, such an appraisal may be for purposes other than providing an opinion of market value.

Many real property appraisers have been uncertain whether a current value opinion, rather than a prospective value opinion, may be provided in compliance with USPAP for a property subject to completion of proposed improvements and, if so, which portions of USPAP are most relevant to the assignment.

Statement on Appraisal Standards No. 4 addresses how an appraiser may provide a prospective value opinion in a manner that is not misleading. This Advisory Opinion provides guidance in performing an assignment involving proposed improvements to real property, whether the purpose of the assignment is to develop a current value opinion or to develop a prospective value opinion.

The value opinion in an appraisal assignment involving proposed improvements is developed on the basis of one or more extraordinary assumptions. Using an extraordinary assumption always requires specific reporting steps. An appraiser must properly address the requirements set forth in Standards Rule 1-2(f) related to use of an extraordinary assumption in developing an appraisal and must address Standards Rules 2-2(a)(x), (b)(x), and (c)(x) in reporting the appraisal opinions and conclusions so as to ensure that the results are credible and not misleading.

ADVICE FROM THE ASB ON THE ISSUE:**Relevant USPAP & Advisory References**

The following USPAP references are applicable when completing an assignment involving proposed improvements to real property:

- **COMPETENCY RULE**, as it relates to the complexity of an appraisal assignment involving proposed improvements;

ADVISORY OPINION 17

- 39 • SCOPE OF WORK RULE particularly regarding laws, regulations, or guidelines which may
40 augment USPAP;
- 41 • JURISDICTIONAL EXCEPTION RULE;
- 42 • STANDARD 1, particularly Standards Rules 1-1(a), 1-2(d), 1-2(e), 1-2(h), 1-3(a); and
- 43 • STANDARD 2, particularly Standards Rules 2-1(a), 2-1(c), and Standards Rule 2-2.

44 Additional standards information is provided in these Statements on Appraisal Standards:

- 45 • No. 2, addressing discounted cash flow analysis;
- 46 • No. 4, explaining that three categories of effective appraisal dates may be used—retrospective,
47 current, or prospective—according to the intended use of the appraisal assignment, and addressing
48 how an appraisal can be prepared and presented in a manner that will not be misleading when a
49 prospective value opinion is required; and
- 50 • No. 6, addressing reasonable exposure time in opinions of value.

51 Additional guidance appears in Advisory Opinion 7, which addresses marketing time opinions. AO-30,
52 *Appraisals for Use by a Federally Regulated Financial Institution* addresses when other requirements may
53 augment USPAP.

54 **General Comments**

55 Both current and prospective value appraisals subject to completion of proposed improvements to real property
56 are permitted under USPAP. As noted in Statement on Appraisal Standards No. 4, a current value appraisal
57 occurs when the effective date of appraisal is contemporaneous with the date of the report, and a prospective
58 value appraisal occurs when the effective date of appraisal is after the date of the report.

59 Development of a value opinion(s) for a subject property with proposed improvements in a current value
60 appraisal involves at least one hypothetical condition, specifically that the described improvements have been
61 completed as of the date of value. The use of a hypothetical condition, in turn, imposes additional reporting
62 requirements as set forth in Standards Rule 1-2(g) and Standards Rules 2-2(a)(x), (b)(x), and (c)(x). The
63 additional reporting requirements are to ensure that an intended user understands that:

- 64 (a) the improved subject property does not yet, in fact, exist as of the date of appraisal;
- 65 (b) the analyses performed to develop the opinion of value are based on a hypothesis, specifically that
66 the improved subject property is assumed to exist when in fact it does not exist;
- 67 (c) certain events need to occur, as disclosed in the report, before the property appraised with the
68 proposed improvements will in fact exist; and
- 69 (d) the appraisal does not address unforeseeable events that could alter the proposed property
70 improvements and/or the market conditions reflected in the analyses.

71 Development of a value opinion based on a hypothetical condition is addressed in Standards Rule 1-2(g). Use of
72 a hypothetical condition is permitted when it is clearly required for legal purposes, for purposes of reasonable
73 analysis, or for purposes of comparison. An analysis based on a hypothetical condition must not result in an
74 appraisal, appraisal review, or appraisal consulting report that is misleading. The hypothetical condition must be
75 clearly and conspicuously disclosed in the report with a description of the hypothetical condition and a
76 statement that its use might have affected the assignment results.

77 There may be laws, regulations or guidelines that affect how and when a hypothetical condition may be used in
78 an appraisal assignment. An appraiser should consider these assignment conditions, but he or she must make
79 certain that developing and reporting a current value opinion under a hypothetical condition in accordance with
80 the assignment conditions still results in an appraisal that complies with USPAP.

81 **Assignment Considerations**

82 An appraiser asked to complete an assignment involving proposed improvements to real property should
83 consider and discuss with the client:

- 84 • the intended use of the appraisal report;
- 85 • the effective date of the appraisal and the date when the proposed improvements are expected to be
86 complete;
- 87 • the physical and economic changes to the existing property and changes in the market for the property
88 that may result from completion of the proposed improvement; and
- 89 • the possible change in market competition from other properties over the time frame of the
90 improvement project.

91 It is important for an appraiser to ensure that the client knows that the differences in the information considered
92 in the two types of analyses can result in significant differences between a current and a prospective value
93 opinion concerning the same subject property.

94 Taken together, these factors and the client's needs determine whether it is most appropriate to develop:

- 95 • a current value opinion on the basis of a hypothetical condition that the proposed improvements
96 already have been completed, or
- 97 • a prospective value opinion on the basis of an extraordinary assumption that the property will be
98 improved as of a future date, as proposed.

99 If a prospective value opinion is the most appropriate, the appraiser must ensure that the requirements set forth
100 in Statement on Appraisal Standards No. 4 are properly met in the course of completing the assignment.

101 As stated in "General Comments" above, an appraisal of a property subject to completion of proposed
102 improvements with a current date of value always involves use of at least one hypothetical condition (i.e., the
103 proposed improvements have been completed as of the date of value), and this always requires reporting that the
104 proposed improvements are appraised as if completed as described in the report, as of the date of value.

105 In an appraisal with a prospective date of value, the extraordinary assumption that the proposed improvements
106 are complete as of that future date must be disclosed clearly and conspicuously. The appraiser also should report
107 that the extraordinary assumption might have affected the assignment results.

108 An appraiser should carefully review Standards Rule 1-2(e) and determine whether the information available for
109 analysis is sufficient to identify the extent and character of the proposed improvements. If sufficient information
110 is not available, an appraiser may use an extraordinary assumption about the extent and character of the
111 proposed improvements, if credible assignment results can still be developed. In an appraisal with a prospective
112 date of value, the extraordinary assumption about the extent and character of the improvements is in addition to
113 the extraordinary assumption about those improvements being completed on the future date of value.

114 A current value opinion assignment does not require an appraiser to provide a prospective value opinion.
115 However, so as to not be misleading the appraisal report should clearly indicate the fact that the value of the
116 property that actually exists as of the date of the report would be different from the value concluded for the
117 property with the proposed improvements completed as described in the hypothetical condition(s) used in the
118 appraisal.

119 **Illustrations:**

120 1. A client is considering financing the construction of a single-family residence. Construction is
121 expected to be complete in six to eight months from the date of the appraisal report. No significant
122 changes in market conditions are foreseeable during the construction period. The client requests a
123 current value opinion based on the hypothetical condition that the improvements are complete as of the
124 current date. Can such an appraisal be provided in compliance with USPAP?

125 Yes, provided sufficient information about the extent and character of the proposed improvements
126 is available or can be reasonably assumed under a hypothetical condition used for purposes of
127 reasonable analysis in this case. Given the intended use of the appraisal (construction financing)
128 and the lack of significant change in the market conditions during the construction period, in this
129 case, a current value appraisal would not be misleading solely on the basis of the hypothetical
130 condition that the improvements are complete as of a current date.

131 2. A client requests an appraisal to assist in establishing contract rent in a build-to-suit agreement. The
132 agreement stipulates that contract rent will be based on a stated percentage of the market value of the
133 property as if it were completed as of a current date. The client requests a current value opinion based
134 on the hypothetical condition that the improvements are complete as of the current date. Can such an
135 appraisal be provided in compliance with USPAP?

136 Yes. Given the intended use of the appraisal, the use of the hypothetical condition is necessary for
137 purposes of reasonable analysis and would not in itself result in a misleading appraisal.

138 3. A client is considering making a current loan on a hotel and requests an opinion of the current value.
139 The current occupancy levels are below 60% and are not expected to improve for at least two years.
140 The client has requested the appraiser to utilize a hypothetical condition which assumes that the
141 occupancy level of the hotel is 70%. Can such an appraisal be provided in compliance with USPAP?

142 No. The resulting appraisal would be misleading because of the combination of the intended use
143 of the appraisal to make a current loan and the market conditions that are expected to affect the
144 subject property.

145 4. A client is considering construction of a large apartment complex. The client expects construction to be
146 complete in about two years. Currently, demand for similar apartment units is strong, but because of
147 the amount of new construction under way or planned in the near future, vacancy levels are expected to
148 rise from the current level (below 1 percent) to about 20 percent in two years.

149 A. The client requests an appraisal with a current value opinion for use in obtaining financing
150 from a non-regulated financial institution, based on the hypothetical condition that the
151 apartment complex is complete and at stabilized occupancy. Can such an appraisal be
152 provided in compliance with USPAP?

153 No, because given the intended use and the foreseeable changes in market competition
154 during the course of construction, a current value opinion for the property, as if
155 complete, would most likely be misleading. A prospective value opinion, with an
156 effective value date as of the expected completion date, would more realistically reflect
157 market conditions affecting the subject property as proposed.

158 B. The client requests an appraisal with a current value opinion for use in testing project
159 feasibility or investment alternatives, based on the hypothetical condition that the apartment
160 complex is complete and at stabilized occupancy. Can such an appraisal be provided in
161 compliance with USPAP?

162 Yes, because the intended use of the appraisal and the hypothesis, in this type of
163 assignment, is for purposes of reasonable analysis and comparison. However, so as not
164 to be misleading, the appraisal analyses should reflect the market risk resulting from the
165 foreseeable trend in vacancy and its probable impact on cash flow and market
166 competition, and the appraisal report must clearly indicate the intended use of the
167 appraisal.

1 **ADVISORY OPINION 18 (AO-18)**

2 *This communication by the Appraisal Standards Board (ASB) does not establish new standards or interpret*
3 *existing standards. Advisory Opinions are issued to illustrate the applicability of appraisal standards in specific*
4 *situations and to offer advice from the ASB for the resolution of appraisal issues and problems.*

5 **SUBJECT: Use of an Automated Valuation Model (AVM)**

6 **APPLICATION: Real Property, Personal Property, Intangible Property**

7 **THE ISSUE:**

8 What steps should an appraiser take when using an AVM as a tool in the development of appraisal, appraisal
9 review, or appraisal consulting opinions and conclusions concerning an individual property?

10 In addition, what steps should an appraiser take when he or she is using an AVM only to process information
11 and communicate the AVM's output but is not performing an appraisal, appraisal review, or appraisal
12 consulting assignment?

13 **BACKGROUND:**

14 This Advisory Opinion addresses how an appraiser may use an AVM.

15 An AVM is a computer software program that analyzes data using an automated process. For example, AVMs
16 may use regression, adaptive estimation, neural network, expert reasoning, and artificial intelligence programs.

17 The output of an AVM is not, by itself, an appraisal. An AVM's output may become a basis for appraisal,
18 appraisal review, or appraisal consulting opinions and conclusions if the appraiser believes the output to be
19 credible for use in a specific assignment.

20 An appraiser can use an AVM as a tool in the development of appraisal, appraisal review, or appraisal
21 consulting opinions and conclusions. However, the appropriate use of an AVM is, like any tool, dependent upon
22 the skill of the user and the tool's suitability to the task at hand.

23 This Advisory Opinion applies when an appraiser uses an AVM in connection with an individual property. This
24 Advisory Opinion does not apply to mass appraising.

25 An appraiser needs to know, before using an AVM, whether it is to be used:

- 26 1. to perform an appraisal, appraisal review, or appraisal consulting service, or
27 2. solely to provide the client with AVM output.

28 When an appraiser uses an AVM to develop his or her own opinions or conclusions in an appraisal, appraisal
29 review, or appraisal consulting assignment, all of the USPAP rules governing that assignment apply and all of
30 this Advisory Opinion is relevant.

31 An appraiser is not performing an appraisal, appraisal review, or appraisal consulting assignment when he or
32 she simply runs an AVM by using information provided by the client and:

- 33 1. does not alter the input or affect the output of the AVM, and
34 2. does not communicate his or her own appraisal, appraisal review, or appraisal consulting opinions
35 or conclusions regarding the AVM's output.

36 If the appraiser uses an AVM only to provide the client with the AVM output, the references to the Conduct
 37 section of the ETHICS RULE and the “Communicating the AVM Output” section in this Advisory Opinion are
 38 relevant.

39 **ADVICE FROM THE ASB ON THE ISSUE:**

40 **Relevant USPAP & Advisory References**

- 41 • Conduct section of the ETHICS RULE:
 42 *An appraiser must not engage in criminal conduct.*
 43 *An appraiser must perform assignments with impartiality, objectivity, and independence, and*
 44 *without accommodation of personal interests.*
 45 *Further, An appraiser must not communicate assignment results with the intent to mislead or to*
 46 *defraud.. An appraiser must not use or communicate a report that is known by the appraiser to be*
 47 *misleading or fraudulent.*
- 48 • The COMPETENCY RULE states, ... *Competency requires: (1) the ability to properly identify*
 49 *the problem to be addressed; and (2) the knowledge and experience to complete the assignment*
 50 *competently; and (3) recognition of, and compliance with, laws and regulations that apply to the*
 51 *appraiser or to the assignment.*
- 52 • The Comment to the COMPETENCY RULE states: *Competency may apply to factors such as, but*
 53 *not limited to, an appraiser’s familiarity with a specific type of property or asset, a market, a*
 54 *geographic area, an intended use, specific laws and regulations, or an analytical method.*
- 55 • SCOPE OF WORK RULE: *The scope of work must include the research and analyses that are*
 56 *necessary to develop credible assignment results... Appraisers have broad flexibility and*
 57 *significant responsibility in determining the appropriate scope of work for an appraisal, appraisal*
 58 *review, and appraisal consulting assignment.” “The appraiser must be prepared to demonstrate*
 59 *that the scope of work is sufficient to produce credible assignment results... An appraiser must*
 60 *not allow the intended use of an assignment or a client’s objectives to cause the assignment results*
 61 *to be biased.*
- 62 • Standards Rule 1-1(a): *An appraiser must be aware of, understand, and correctly employ those*
 63 *recognized methods and techniques that are necessary to produce a credible appraisal.*
- 64 • Standards Rule 1-1(b): *An appraiser must not commit a substantial error of omission or*
 65 *commission that significantly affects an appraisal.*
- 66 • Standards Rule 1-1(c): *An appraiser must not render appraisal services in a careless or negligent*
 67 *manner, such as by making a series of errors that, although individually might not significantly*
 68 *affect the results of an appraisal, in the aggregate affect the credibility of those results.*
- 69 • Standards Rule 1-6(b): *An appraiser must reconcile the applicability and relevance of the*
 70 *approaches, methods and techniques used to arrive at the value conclusion(s).*
- 71 • STANDARD 2: *In reporting the results of a real property appraisal, an appraiser must*
 72 *communicate each analysis, opinion, and conclusion in a manner that is not misleading.*
- 73 • STANDARD 3: *In developing an appraisal review assignment, an appraiser acting as a reviewer*
 74 *must identify the problem to be solved, determine the scope of work necessary to solve the*
 75 *problem, and correctly complete research and analyses necessary to produce a credible appraisal*
 76 *review. In reporting the results of an appraisal review assignment, an appraiser acting as a*
 77 *reviewer must communicate each analysis, opinion, and conclusion in a manner that is not*
 78 *misleading.*
- 79 • Statement on Appraisal Standards No. 9: *Although an appraiser must identify and consider the*
 80 *intended use of the appraiser’s opinions and conclusions, an appraiser must not allow the*
 81 *objectives of the client or other intended users of the report to affect the appraiser’s independence*
 82 *and objectivity. An appraiser must not allow the objectives of a client or other intended users to*
 83 *cause the analysis or report to be biased.*

84 **Competency**

85 When an appraiser is asked to use an AVM in an assignment, the appraiser must ensure that he or she can
86 comply with the requirements of the COMPETENCY RULE both prior to accepting the assignment and in the
87 course of performing it.

88 In an appraisal assignment, an appraiser must have a basic understanding of how the AVM works in order to
89 reasonably determine that:

- 90 1. use of the AVM is appropriate for the assignment;
- 91 2. the output of the AVM is credible for use in the assignment; and
- 92 3. the AVM does not exclude relevant market measures or factual information necessary for a
93 credible calculation.

94 A client may suggest or request the use of an AVM in an appraisal, appraisal review, or appraisal consulting
95 assignment, but ultimately the appraiser is responsible for the decision to use or not use the AVM and its output.
96 The appraiser must be able to reasonably conclude that the AVM's output is credible before deciding to use the
97 AVM or rely on its output. For example, in an appraisal assignment, the credibility of the AVM output may be
98 established by comparison to the subject market. If the appraiser concludes that using the AVM output in an
99 assignment would be misleading, the appraiser should either use other tools to perform the analysis or decline
100 the assignment.

101 **Under What Conditions May AVMs Be Used?**

102 There are five critical questions to which the appraiser should answer "yes" before deciding to use an AVM in
103 an appraisal, appraisal review, or appraisal consulting assignment:

- 104 1. Does the appraiser have a basic understanding of how the AVM works?
- 105 2. Can the appraiser use the AVM properly?
- 106 3. Are the AVM and the data it uses appropriate given the intended use of assignment results?
- 107 4. Is the AVM output credible?
- 108 5. Is the AVM output sufficiently reliable for use in the assignment?

109 The answers to these questions may be affected by the degree to which the appraiser can interact with the AVM.
110 The decision to use an AVM may also be affected by support information supplied by the AVM's developer,
111 the appraiser's previous experience in using the AVM, or other available information.

112 **Database**

113 Credibility of the AVM output depends on the quality of its database and how well the AVM is designed to
114 analyze that database. When using an AVM in an appraisal, appraisal review, or appraisal consulting
115 assignment, the appraiser must have reason to believe the AVM appropriately uses data that are relevant.

116 **Understanding and Control of the AVM**

117 When using an AVM in an appraisal, appraisal review, or appraisal consulting assignment, an appraiser should
118 have a basic understanding of how the AVM analyzes data to determine whether the AVM measures and
119 reflects market activity for the subject property. The appraiser does not need to know, or be able to explain, the
120 AVM's algorithm or intricacies of its statistical or mathematical formulae. However, the appraiser should be
121 able to describe the AVM's overall process and verify that the AVM is consistent in producing results that
122 accurately reflect prevailing market behavior for the subject property.

123 AVMs differ in the number and type of data characteristics as well as in the volume of data analyzed. The
124 appraiser should know which characteristics (e.g., size, location, quality) are analyzed and how the analysis is

125 tested for accuracy and reasonableness. The appraiser should ascertain that the characteristics analyzed are
126 those to which the market responds.

127 Some AVMs allow the appraiser to select the data analyzed on the basis of, for example, distance from subject,
128 size, or age of the improvements. An appraiser's ability to change the AVM's selection parameters may affect
129 the appraiser's decision to use or rely on the AVM output.

130 The appraiser should be aware that the AVM may not perform consistently given the same input criteria. The
131 appraiser should be confident of the AVM's credibility when applied to a specific property. The appraiser
132 decides whether to rely on the AVM output, regardless of the AVM's overall test performance. In some cases,
133 the appraiser may accept the AVM's output, while in other cases that same AVM's output would not be
134 acceptable.

135 **Communicating the AVM Output**

136 An appraiser must ensure that his or her communication of an AVM's output is not misleading.

137 An AVM's output is not, by itself, an appraisal, and communication of an AVM's output is not, in itself, an
138 appraisal report. When an AVM is used in an appraisal, appraisal review, or appraisal consulting assignment,
139 information furnished about an AVM in the appraiser's report must satisfy the reporting requirements
140 applicable to the type of report provided (e.g., in the case of a real property appraisal, a Self-Contained,
141 Summary, or Restricted Use Appraisal Report). The appraiser should cite the name and version of the AVM
142 software and provide a brief description of its methods, assumptions, and level of allowed user intervention.
143 The report should, to the extent possible, identify the database (e.g., Multiple Listing Services) and the data
144 analyzed.

145 An appraiser bound by USPAP may be asked to run an AVM and communicate its output without performing
146 an appraisal, appraisal review, or appraisal consulting assignment. For example, an appraiser may be asked to
147 simply enter property characteristics provided by the client but not alter the input or affect the AVM's output. In
148 this specific instance, the appraiser is not acting in the capacity of an appraiser but rather is functioning only as
149 an AVM operator. In such a situation, an appraiser must carefully avoid any action that could be considered
150 misleading or fraudulent. The appraiser should take steps to ensure that communication of the AVM's output is
151 not misconstrued as an appraisal, appraisal review, or appraisal consulting report. For example, the appraiser
152 should:

- 153 1. not communicate his or her opinions or conclusions as an appraiser regarding the credibility or
154 reliability of the AVM's output;
- 155 2. not provide an appraiser's certification or statement of limiting conditions in connection with the
156 AVM's output; and
- 157 3. ensure that his or her role as only an AVM operator is clearly indicated if his or her signature or
158 other identification marks appear on document(s) used to communicate the AVM's output.

159 **Analyzing an AVM's Effectiveness**

160 An appraiser bound by law, regulation, or an agreement to comply with USPAP may be asked to analyze and
161 comment on the effectiveness of an AVM for a stated intended use. Such a request involves an aspect of value
162 and thereby this would be an appraisal practice service, but one for which USPAP has no specific performance
163 standards. In order to accept such an assignment, an appraiser bound to comply with USPAP must ensure
164 compliance with the ETHICS RULE, the COMPETENCY RULE, and the JURISDICTIONAL EXCEPTION
165 RULE. To meet the COMPETENCY RULE, at a minimum, the appraiser should also have a basic
166 understanding of how the AVM works.

167 **Review of the Output of an AVM**

168 An appraiser bound by law, regulation, or an agreement to comply with USPAP may be asked if the output of
169 an AVM is credible for a specific property, given the intended use of the AVM’s output. Such a request
170 involves an aspect of value and thereby making this determination is an appraisal practice service, but one for
171 which USPAP has no specific performance standards. The appraiser must ensure compliance with the ETHICS
172 RULE, the COMPETENCY RULE, and the JURISDICTIONAL EXCEPTION RULE.

173 **Review of an Appraisal Report Containing Output of an AVM**

174 An appraiser may be asked to review an appraisal report that includes an opinion of value based on the output of
175 an AVM. This is an appraisal review assignment under USPAP which must follow the requirements of
176 STANDARD 3. This kind of appraisal review assignment may be accepted if the appraiser performing the
177 review understands how the AVM works and can form an opinion as to the adequacy and relevancy of the data
178 and the appropriateness of the analysis, based on the information provided in the report under review.

179 **Use of an AVM in an Appraisal Review Assignment**

180 An AVM may be used in the process of reviewing a real property appraisal report. The appraisal reviewer may
181 use the AVM to test the reasonableness of the value conclusion in the report under review if the appraisal
182 reviewer has a basic understanding of how the AVM works, can use the AVM properly, determines that use of
183 the AVM is appropriate for the appraisal review assignment, and believes the AVM output is credible and
184 sufficient for the appraisal review assignment.

185 **Illustrations:**

186 1(a). Staff Appraiser D, who has access to market databases, is asked to use an AVM to process
187 information. When Appraiser D runs the AVM, she has done no other appraisal research. Appraiser D
188 does not apply any of her appraisal knowledge or judgment in operating the AVM. Appraiser D has
189 entered only property characteristics provided by the client and does not know how the AVM analyzes
190 the data. Is the AVM output an appraisal?

191 No. The AVM output by itself is not an appraisal. Appraiser D did not apply her appraisal
192 knowledge, judgment, or expertise, nor did she represent that the output was her own opinion of
193 value.

194 Appraiser D must be very careful in communicating the AVM output to ensure that there is no
195 misunderstanding as to her role in operating the AVM or communicating its output. For example,
196 Appraiser D should:

- 197 1. not communicate her opinions or conclusions as an appraiser regarding the credibility or
198 reliability of the AVM’s output;
- 199 2. not provide an appraiser’s certification or statement of limiting conditions in connection with
200 the AVM’s output; and
- 201 3. ensure that her role as only an AVM operator is clearly indicated if her signature or other
202 identification mark appears on documents used to communicate the AVM’s output.

203 1(b). Staff Appraiser D receives AVM output from a coworker who is not an appraiser. Appraiser D is
204 requested to determine if the AVM output is credible, given the intended use. What can Appraiser D
205 do?

206 Appraiser D should not express an opinion regarding value. However, the request involves an
207 aspect of value and, therefore, Appraiser D can indicate if the AVM output is credible. USPAP
208 includes no specific performance standards for this kind of service. However, because performing

209 the service requires an appraiser to consider an aspect of property value, it is part of appraisal
 210 practice. Appraiser D must, therefore, ensure compliance with the ETHICS RULE, the
 211 COMPETENCY RULE, and the JURISDICTIONAL EXCEPTION RULE.

212 1(c). After staff Appraiser D has received the AVM output, can she incorporate the information into the
 213 appraisal process?

214 Yes. However, Appraiser D must be able to understand how the AVM works and determine that
 215 the information analyzed is credible and reliable.

216 2. Appraiser V provides residential appraisals to Client A, whose intended use is to document security for
 217 equity lines of credit. Appraiser V has determined that Orange Box AVM is sufficiently reliable to use
 218 as a tool in these appraisals. Orange Box AVM was recently used by Appraiser V on a house in a
 219 suburban single-family residential subdivision.

220 Client B requests Appraiser V to use Orange Box AVM, alone, for a relocation appraisal assignment
 221 on an identical house in the same subdivision. Can Appraiser V use Orange Box AVM alone in this
 222 relocation appraisal assignment?

223 AVM itself and the AVM output for Client A’s needs may not be appropriate for Client B’s needs.

224 Client A’s intended use of the appraisal is to document security for an equity line of credit.
 225 Typically, Client A’s lending decision is based primarily on the homeowner’s capacity to pay the
 226 debt and only secondarily on the value of the house. The reliability expectation of the value
 227 opinion needed by Client A is relatively low.

228 The intended use of the relocation appraisal for Client B is to develop an opinion of a sale price of
 229 the house under very specific conditions. Typically, the reliability expectation of the opinion
 230 needed by Client B is relatively high because his or her intended use involves a near-term transfer
 231 of the house, with immediate financial implications. Appraiser V must determine if Orange Box
 232 AVM’s output is sufficiently reliable to meet Client B’s stated expectations.

233 3(a). Appraiser A developed a regression analysis model that suggests a relationship between the size of a
 234 residence and the price per square foot of similar residences in a specific market. This relationship has
 235 been confirmed by market behavior, and the database used is believed to be reliable. Can the appraiser
 236 use the regression analysis model in other appraisal assignments of similar properties in the same
 237 market?

238 Yes, because the appraiser knows how the regression analysis model works, has independently
 239 tested the conclusions it provides, and believes the database is reliable. However, the appraiser
 240 must consider whether the AVM output is credible and reliable for each assignment on a case by
 241 case basis.

242 3(b). Appraiser A’s friend, Appraiser B, works in a different market area. Appraiser B is impressed with
 243 Appraiser A’s model and wants to use the model in Appraiser B’s market area. Can Appraiser B use
 244 Appraiser A’s model?

245 Yes, if Appraiser B understands how Appraiser A’s model works and verifies by independent
 246 testing that the model produces reliable results in Appraiser B’s market area and that the database
 247 used by Appraiser B reflects behavior in Appraiser B’s market area. However, the appraiser must
 248 consider whether the AVM output is credible and reliable for each assignment on a case-by-case
 249 basis.

250 4(a). A client of Appraiser A requests that Appraiser A use Blue Box AVM. The client says, “Since we are
251 only doing residential appraisals, you can skip the cost and income approach. To lower the cost of the
252 appraisal just use the Blue Box AVM results as the basis for your value conclusion.” The client also
253 says, “Blue Box AVM makes thirteen adjustments, and that is all that the appraiser needs to be
254 concerned with.” The Blue Box AVM developer feels that appraisers cannot understand this new
255 technology and that appraisers do not need to know how the thirteen adjustments are made. What
256 should Appraiser A do?

257 Appraiser A should:

- 258 1. learn how the Blue Box AVM works;
259 2. determine if he can use the AVM properly; and,
260 3. given the intended use, determine if the output of Blue Box AVM is credible and sufficiently
261 reliable for use in the assignment.

262 If Appraiser A cannot understand how the Blue Box AVM works or concludes that the results are
263 not credible, given the intended use, Appraiser A should discuss the issue with the client. This
264 discussion may result in a modified scope of work or in the appraiser declining the assignment.

265 4(b). Another client requests that Appraiser A consider Green Box AVM. The client indicates that Appraiser
266 A can modify six of the thirteen items analyzed in Green Box AVM, such as the distance within which
267 the comparables are selected and the size range (square footage) of the comparables. The developer of
268 Green Box AVM will also describe how the AVM works and provide the results of test data, which
269 indicate that the model is reliable. What should Appraiser A do?

270 Appraiser A needs to follow the same steps described in 4(a).

271 5. Appraiser C’s client has licensed the Red Box AVM. The client requests that Appraiser C use the Red
272 Box AVM as a tool in an appraisal consulting assignment. The client knows that Appraiser C has a
273 reliable internal residential database. The client also knows that Appraiser C has tested Red Box AVM
274 and has found it to be reliable. Further, the software developer of Red Box AVM has given Appraiser
275 C information about how Red Box AVM works and test data showing its results. Can Appraiser C
276 apply the Red Box AVM in the appraisal consulting assignment?

277 Yes, if the Red Box AVM is used for that part of the process for which it has been determined to
278 be credible and reliable. However, the appraiser must consider whether the AVM output is
279 credible and reliable for each assignment.

ADVISORY OPINION 19 (AO-19)

This communication by the Appraisal Standards Board (ASB) does not establish new standards or interpret existing standards. Advisory Opinions are issued to illustrate the applicability of appraisal standards in specific situations and to offer advice from the ASB for the resolution of appraisal issues and problems.

SUBJECT: Unacceptable Assignment Conditions in Real Property Appraisal Assignments

APPLICATION: Real Property

ISSUE:

All real property appraisal assignments involve conditions that affect the appraiser’s scope of work and the type of report. What types of assignment conditions are unacceptable?

BACKGROUND:

Many residential property appraisers report requests for service where the caller includes statements or information in the request similar to the following:

1. We need comps for (property description) that will support a loan of \$ _____; can you provide them?
2. Sales Price: _____.
3. Approximate (or Minimum) value needed: _____.
4. Amount needed: _____.
5. Owner’s estimate of value: _____.
6. If this property will not appraise for at least _____, stop and call us immediately.
7. Please call and notify if it is NOT possible to support a value at or above _____, BEFORE YOU PROCEED!!!!

Appraisers report that the caller usually makes it clear that they do not want the appraiser to do any fieldwork. Some callers refer to the service requested as a “comp check” while others refer to it as a “preliminary appraisal” or use some terms other than appraisal (such as preliminary evaluation, study, analysis, etc.). Some callers indicate that if the numbers will not work, the appraiser can send a bill for research services or a “preliminary” inspection. Other callers promise future assignments if the appraiser can make the present deal work.

Appraisers ask, “Can I respond to such requests without violating USPAP and, if so, how?”

ADVICE FROM THE ASB ON THE ISSUE:

Relevant USPAP & Advisory References

Appraisers receiving requests for services that include the kind of information and situations described in the Background section of this Advisory Opinion should carefully review:

- The Conduct and Management sections of the ETHICS RULE, particularly in regard to assignments offered under condition of “predetermined opinions or conclusions” or compensation conditioned on the reporting of a predetermined value result, a direction in assignment results that favors the cause of the client, the amount of a value opinion, the attainment of a stipulated result, or the occurrence of a subsequent event directly related to the appraiser’s opinions and specific to the assignment’s purpose.

ADVISORY OPINION 19

- 39 • The definitions of “Appraisal,” “Appraisal Practice,” “Assignment” and “Scope of Work” in the
40 DEFINITIONS section of USPAP.
- 41 • Standards Rule 1-1(b), particularly as it relates to diligence in the level of research and analysis
42 necessary to develop credible opinions and conclusions.
- 43 • Standards Rules 1-2(f), (g), and (h), regarding identification of the scope of work necessary to
44 complete an assignment and any extraordinary assumptions or hypothetical conditions necessary
45 in an assignment.
- 46 • Standards Rules 1-5(a) and (b), regarding the analysis of current or historical market activity
47 regarding the property appraised.
- 48 • The SCOPE OF WORK RULE, with particular attention to the appraiser’s responsibility in
49 connection with the scope of work decision and disclosure obligations
- 50 • As guidance, Advisory Opinions 11, 12, and 13.

51 Unacceptable Conditions

52 Certain types of conditions are unacceptable in any assignment because performing an assignment under such
53 conditions violates USPAP. Specifically, an assignment condition is unacceptable when it:

- 54 • precludes an appraiser’s impartiality, because such a condition destroys the objectivity and
55 independence required for the development and communication of credible results;
- 56 • limits the scope of work to such a degree that the assignment results are not credible, given the
57 intended use of the assignment; or
- 58 • limits the content of a report in a way that results in the report being misleading.

59 Accepting Assignment Conditions

60 The intended use of the assignment results affect whether assignment conditions are acceptable. Some
61 assignment conditions may be acceptable in one type of assignment but not in another. An appraiser should
62 carefully consider the information provided by the client in a prospective assignment before accepting or
63 declining the assignment. (See Statement on Appraisal Standards No. 9.)

64 In the highly competitive financial services market, cost versus benefit is always an issue. Residential
65 appraisers, particularly, have seen an increase in the use of sophisticated loan application screening tools by
66 their lender-clients. Many lenders believe an appraiser can enhance their screening efforts by doing
67 “preliminary work” that they do not view as an “appraisal.”

68 Other client groups also ask appraisers to provide services under conditions that limit the appraiser’s scope of
69 work. Investors, trust administrators, and portfolio account managers often require opinions and data from
70 appraisers in order to make decisions. Attorneys often rely on appraisers in counseling their clients and in
71 preparing for litigation.

72 When considering a request for service, appraisers should ascertain:

- 73 • whether the service involves an appraisal,
- 74 • what levels of risk are associated with the service, and
- 75 • whether there are any unacceptable conditions attached to the assignment.

76 Appraisers should take care to communicate with prospective clients to reach a common understanding about
77 assignment conditions. Further, the appraiser and client need to recognize that:

- 78 **1) the type of assignment in each request described in the Background section of this Advisory**
79 **Opinion is an appraisal.**

80 If an appraiser is asked whether a specific property has a value (a point, a range, or a relationship to some
81 benchmark), that request is for an opinion of value (an appraisal). Appraisers, obligated to comply with USPAP,
82 must develop a real property appraisal in accordance with STANDARD 1. Communicating that value opinion
83 must be accomplished in accordance with STANDARD 2.

84 Appraisers, like other professionals, must ensure that those who use their services recognize the amount of work
85 required—and the expertise needed—to develop a credible value conclusion about a property.

86 However, this does not mean that the appraiser cannot provide an economic and competitive service. Indeed,
87 the *Uniform Standards of Professional Appraisal Practice* recognize the need for different kinds of appraisals.
88 A competent appraiser can vary the scope of work in an assignment, in accordance with the type and definition
89 of value and intended use of the appraiser’s opinions and conclusions in the assignment, and remain in
90 compliance with USPAP.

91 **2) assignment limitations affect the level of risk accepted by each party in an assignment;**

92 Appraisers and users of appraisals should recognize that assignment limitations affect the reliability of an
93 appraiser’s opinions and conclusions. In some assignments, an appraiser can reasonably apply extraordinary
94 assumptions to compensate for assignment limitations. In other situations, the use of the same assumptions may
95 not be acceptable.

96 When the intended use is to screen a potential business for feasibility, the use of assumptions or extraordinary
97 assumptions is more appropriate than when the intended use is for loan documentation or loan settlement.
98 Because intended users’ reliance on an appraisal may be affected by the scope of work, the report must enable
99 them to be properly informed and not misled.

100 **3) assignment conditions that compromise an appraiser’s impartiality and objectivity in an**
101 **assignment are unacceptable.**

102 While a client may feel that offering preference in current or future assignments on the basis of “making the
103 numbers work” in a specific assignment is appropriate, attaching such a condition to an assignment
104 compromises an appraiser’s impartiality and destroys the appraiser’s credibility.

105 The *Uniform Standards of Professional Appraisal Practice* is explicit about such matters. Accepting an
106 appraisal assignment under such a condition violates the Conduct section of the ETHICS RULE in USPAP,
107 which states:

108 *An appraiser must perform assignments with impartiality, objectivity, and independence, and without*
109 *accommodation of personal interests.*

110 *An appraiser must not accept an assignment that includes the reporting of predetermined opinions*
111 *and conclusions.*

112 Furthermore, accepting compensation for completing an appraisal assignment under such a condition violates
113 the Management section of the ETHICS RULE in USPAP, which states:

114 *It is unethical for an appraiser to accept an assignment, or to have a compensation arrangement for an*
115 *assignment, that is contingent on any of the following:*

- 116 1. *the reporting of a predetermined result (e.g., opinion of value);*
- 117 2. *a direction in assignment results that favors the cause of the client;*
- 118 3. *the amount of a value opinion;*
- 119 4. *the attainment of a stipulated result; or*

ADVISORY OPINION 19

- 120 5. *the occurrence of a subsequent event directly related to the appraiser's opinions and specific to*
121 *the assignment's purpose.*

122 **Illustrations:**

123 Some of the requests shown in the Background section of this Advisory Opinion share common characteristics.
124 Possible responses to each common group of requests could be:

- 125 1. *We need comps for (a specific property) that will support a loan of _____; can you provide*
126 *them?*

127 “Maybe, but I’ll need to research the market to know whether the ‘comps’ will support a value range
128 relative to the loan amount. In doing this, I will be deciding which sales are ‘comps’ and what those
129 ‘comps’ mean. Those decisions will result in a range of value for your prospective borrower’s property,
130 which is an appraisal.

131 You also need to recognize that there are risks in this kind of assignment. You should realize that my
132 value conclusion could change if I subsequently perform an appraisal. Under the research and analysis
133 limitations you suggest, I would not have verified some of the data and would have to use
134 extraordinary assumptions about the market data and your borrower’s property information. I would
135 not have performed some of the analyses steps I might complete in an appraisal assignment without
136 those limitations. If all of that is agreeable to you, we can proceed.”

- 137 2. *Sales Price: _____.*

138 “As long as the amount is only to inform me of the pending contract [or of the sale price] and is not a
139 condition for your placement of this assignment with me, we can proceed. However, if that amount is a
140 condition of this assignment, accepting an assignment under that condition violates professional
141 ethics.”

142 Note: A sale price (in a pending or a settled transaction) is part of the information an appraiser is
143 required to ascertain in accordance with Standards Rules 1-5(a) and (b). Receiving this information
144 with a request for service is appropriate, but accepting an assignment with the price in an agreement of
145 sale, option, or listing or a sale price in a settled transaction as a predetermined value in the assignment
146 violates USPAP.

- 147 3. *Approximate (or Minimum) value needed: _____.*

- 148 4. *Amount needed: _____.*

- 149 5. *Owner's estimate of value: _____.*

150 “As long as the amount is only to inform me of your objectives or someone else’s opinion and is not a
151 condition for your placement of this assignment with me, we can proceed. However, if that amount is a
152 condition of this assignment, accepting an assignment under that condition violates professional
153 ethics.”

- 154 6. *If this property will not appraise for at least _____, stop and call us immediately.*

- 155 7. *Please call and notify if it is NOT possible to support a value at or above _____, BEFORE*
156 *YOU PROCEED!!!!*

157 “Your request is acknowledged, but it is important for you to be aware that I must develop an appraisal
158 before I can tell you whether the property will support the value indicated. It is also important for you
159 to be aware that your statement of that amount with this request for service does not, in my view,
160 establish a ‘condition’ for my performing the appraisal. If you intend it to be a condition for
161 performing the assignment, I cannot accept the assignment because it violates professional ethics.”

162 **Research Illustration:**

163 The foregoing illustrations all include an appraisal assignment. In some situations, a client will request a service
164 that is not an appraisal, appraisal review or appraisal consulting assignment as defined in USPAP. The service
165 to be performed by the appraiser in the following illustration is:

- 166 • not an appraisal assignment (the appraiser does not develop a value opinion);
- 167 • not a real property appraisal consulting assignment (a value opinion is not a component of the
168 analysis); and
- 169 • not a real property appraisal review (there is no appraisal to review).

170 The caller in this illustration is usually in the process of making a business decision and needs impartial and
171 objective information but has not yet decided whether to pursue the matter at hand. The caller knows there is the
172 potential for needing an appraisal, depending, in part, on what the sales data shows. The caller also believes
173 that, if the data indicates that an appraisal is worthwhile, having that work completed by the appraiser in that
174 subsequent assignment will lessen the time required to perform an appraisal. The prospective client may ask:

175 “We want you to check your data resources to see if there are sales within the past six months that are
176 within one mile of [address]. If you find some, we may order an appraisal from you.”

177 One possible response would be:

178 “If what you want is only the sales of properties shown in the databases available to me with the
179 criteria you specified, I can do that research and send you the result. Then you can decide what you
180 think your client’s property is worth. If I do only that, it is just research and is not an appraisal.

181 However, you need to recognize that there are risks if you decide to have the research done that way. If
182 you decide to limit my work to just gathering the sales data using the research criteria you set, you are
183 taking the risk that those criteria are both adequate and appropriate to find all of the market data
184 relevant to your client’s property. You also take the risk that any appraiser’s analysis of that data would
185 result in a value conclusion within the price range suggested by the sales data assembled using your
186 criteria. There is no assurance that such would be the case.”

187 **Staff or Multi-Appraiser Firm Context**

188 The foregoing illustrations reflect communications between a client and an appraiser in the context of the
189 appraiser as an independent contractor (fee appraiser).

190 In a staff context, such as where the appraisal function is established as a business or agency unit, the part of the
191 entity that uses the appraiser’s opinions and conclusions represents the “client” (intended user) and the part that
192 completes the assignment represents the “appraiser.”

193 In that context, the “assignment” originates from the “intended user” part of the entity. The appraisal unit’s
194 response to an “intended user” in situations like those in the foregoing illustrations reasonably could be similar
195 because imposing assignment conditions that compromise an appraiser’s impartiality and objectivity is
196 unacceptable, whatever the setting.

197 However, the example responses in the illustrations do not apply to the customary interaction and dialogue that
198 occurs between appraisers within organizations or peers in multi-appraiser firms. Such interaction and dialogue
199 within the unit or group that develops the opinions and conclusions in an assignment is not the same as
200 communicating opinions and conclusions to an intended user.

ADVISORY OPINION 20

1 **ADVISORY OPINION 20 (AO-20)**

2 *This communication by the Appraisal Standards Board (ASB) does not establish new standards or interpret*
3 *existing standards. Advisory Opinions are issued to illustrate the applicability of appraisal standards in specific*
4 *situations and to offer advice from the ASB for the resolution of appraisal issues and problems.*

5 **SUBJECT: An Appraisal Review Assignment That Includes the Reviewer’s Own Opinion of**
6 **ValueAPPLICATION: Real Property, Personal Property, Intangible Property**

7 **THE ISSUE:**

8 A client may want an appraiser, functioning as a reviewer, to develop and report his or her own opinion of value
9 (i.e., an appraisal) within an appraisal review assignment. This leads to two questions:

10 How does the assignment change when the reviewer’s scope of work includes the development of his
11 or her own opinion of value?

12 What language in appraisal review reports indicates when the reviewer did or did not develop his or
13 her own opinion of value?

14 **BACKGROUND:**

15 Appraisal review is a specialized area of appraisal practice. Appraisal reviews are used in a variety of business,
16 governmental, and legal situations and also have an important role in the enforcement of professional standards.

17 STANDARD 3 allows the reviewer to address all or part of the work under review (also referred to in this
18 Advisory Opinion as the “original work”). In every appraisal review assignment, the reviewer is required to
19 “...*identify the problem to be solved, determine the scope of work necessary to solve the problem, and correctly*
20 *complete research and analyses necessary to produce a credible appraisal review.*” The reviewer’s opinion
21 about the quality of the work under review can include addressing its completeness, relevance, appropriateness,
22 and reasonableness, all in the context of the requirements applicable to that work.

23 However, a client may also want the reviewer to develop and report his or her own opinion of value (an
24 appraisal) within an appraisal review assignment. In this instance, the appraisal review assignment is actually a
25 two stage assignment: an appraisal review *plus* a value opinion by the reviewer.

26 The purpose and intended use together, of an appraisal review assignment, affect the scope of work in an
27 assignment. Therefore, it is essential that reviewers clearly identify the purpose and intended use of the
28 appraisal review and establish a well defined scope of work with their client to ensure a clear understanding of
29 what steps are and are not necessary in an assignment.

30 This Advisory Opinion provides guidance to help appraisers, clients, and other users or readers of an appraisal
31 review report:

- 32 A. recognize how terminology used in STANDARD 3 and in this Advisory Opinion prevents confusion as to
33 the function the reviewer is fulfilling in an appraisal review assignment;
- 34 B. understand how the purpose of the appraisal review and the intended use of the appraisal review results
35 affect the scope of work in an appraisal review assignment;
- 36 C. recognize how the scope of work changes when an appraisal review assignment includes a requirement for
37 the reviewer to develop and report his or her own opinion of value concerning the subject property of the
38 work under review; and
- 39 D. understand how the language in an appraisal review report can be used to indicate whether a value opinion
40 was or was not developed by the reviewer.

41 **ADVICE FROM THE ASB ON THE ISSUE:**

42 **Relevant USPAP & Advisory References**

- 43 • DEFINITIONS section, specifically the definition of “Appraisal,” “Appraisal Review,” and
- 44 “Assignment”
- 45 • STANDARD 3

46 Portions of the referenced material are cited in this Advisory Opinion. An appraiser performing an appraisal
 47 review assignment should carefully study the complete text to ensure a proper understanding of the
 48 requirements and the text in STANDARDS 1, 4, 6, 7, or 9, as applicable, as well as those in STANDARD 3.

49 **A. TERMINOLOGY**

50 When reading the references cited above, appraisers performing appraisal review assignments (referred to as
 51 “reviewers” in USPAP) should note that the terminology used in STANDARD 3 have very specific meanings.

52 The term “Appraisal Review” is used in USPAP to identify the activity of a reviewer in an appraisal review
 53 assignment. Appraisers sometimes use such terms as “Desk Review,” “Field Review,” “Complete Review,”
 54 “Limited Review,” “Technical Review,” and “Administrative Review.” However, without appropriate
 55 explanation, these terms and phrases can result in misunderstanding about the function being performed by a
 56 reviewer. While such terms may be convenient labels for use in a business setting, they do not necessarily
 57 impart the same meaning in every situation.

58 Rather than simply using labels, reviewers should also accurately define the scope of work — in fact, the
 59 Comment to Standards Rule 3-2(h) requires the reviewer to “...*determine the scope of work necessary to*
 60 *produce credible assignment results in accordance with the SCOPE OF WORK RULE*” and Standards Rule 3-
 61 5(g) requires the reviewer to “*state the scope of work used to develop the appraisal review...*” These
 62 requirements are designed to ensure that an intended user of appraisal review results is not misled as to the
 63 reviewer’s scope of work and the basis for his or her opinions and conclusions.

64 The terms “Review Appraisal” and “Review Appraiser” are also sometimes used in practice, primarily to refer
 65 to the marketing of services or to an appraiser’s functional status in employment. These phrases are not used in
 66 STANDARD 3, in part to avoid giving confusing implications, such as, for example, the impression that an
 67 appraisal is always part of a review.

68 **B. HOW PURPOSE AND INTENDED USE AFFECT SCOPE OF WORK**

69 A reviewer’s scope of work in an appraisal review assignment is determined primarily by the purpose(s) of the
 70 assignment and the intended use of the assignment results. Standards Rule 3-2(b) requires, in part, that the
 71 reviewer must “*identify ... the intended use of the reviewer’s opinions and conclusions.*” In addition,
 72 Standards Rule 3-2 (c) states the reviewer must “*identify the purpose of the appraisal review, including*
 73 *whether the assignment includes the development of the reviewer’s own opinion of value, review opinion or*
 74 *real property appraisal consulting conclusion related to the work under review.*”

75 Examples of intended use include (without limitation) quality control, audit, qualification, or confirmation.
 76 Each type of intended use affects the scope of work that may be appropriate for a particular appraisal review
 77 assignment.

78 As examples, a client may want the reviewer to develop and report an opinion as to the quality of another
 79 appraiser’s work, *and:*

- 80 1. only state the corrective action to be taken by the appraiser with regard to curing any deficiency,
 81 leaving the client to decide whether to interact with the appraiser to accomplish the correction; or

- 82 2. act on behalf of the client to interact with the appraiser that prepared the original work to ensure any
83 deficiency is appropriately corrected by that appraiser; or
- 84 3. make corrections to cure an error, such as a mathematical miscalculation, by showing what the
85 calculation would have been if correct but without expressing the result as the reviewer's own opinion
86 of value; or
- 87 4. make corrections to cure a deficiency, expressing the result as the reviewer's own opinion of value,
88 which is to be developed within the same scope of work as was applicable in the assignment that
89 generated the original work; or
- 90 5. make corrections to cure a deficiency, expressing the result as the reviewer's own opinion of value,
91 which is to be developed using a different scope of work than was applicable in the assignment that
92 generated the original work; or
- 93 6. regardless of the appraisal review result, develop his or her own opinion of value using the same scope
94 of work as was applicable in the assignment that generated the original work; or
- 95 7. regardless of the appraisal review result, develop his or her own opinion of value using a different
96 scope of work than was applicable in the assignment that generated the original work.

97 In Examples 1, 2, and 3 the reviewer has not taken any steps to offer his or her own opinion of value, and
98 therefore, has not bridged over into the appraisal stage.

99 In Examples 4, 5, 6, and 7, the appraisal review assignment is actually a two stage assignment—an appraisal
100 review *plus* a value opinion by the reviewer. It is also important to note that this second stage occurs even if the
101 reviewer concurs with the value opinion in the original work. This is because a reviewer's concurrence in a
102 value opinion developed by another appraiser converts it to the reviewer's *own* opinion of value—in effect, the
103 reviewer is taking ownership of that value by concurring with it. As such, it constitutes a value opinion (i.e.,
104 appraisal) by the reviewer.

105 In Examples 6 and 7, the client might, alternatively, engage the reviewer (as an appraiser) in a separate
106 assignment to perform an appraisal outside the context of the appraisal review assignment.

107 In any case, the reviewer must carefully develop the scope of work as required by SR 3-2(h) and state the scope
108 of work in the report as required by SR 3-5(g). The concluding language used (see illustrations to follow)
109 should also be consistent with the scope of work decision.

110 **C. SCOPE OF WORK AND THE REVIEWER'S OPINION OF VALUE**

111 An appraisal review assignment that includes a requirement for the reviewer to develop his or her own opinion
112 of value imposes on the reviewer an expanded scope of work. This additional scope of work requirement is set
113 forth in the Comment to SR 3-2(h), which states, in part:

114 ***Determine the scope of work necessary to produce credible assignment results in accordance with the***
115 ***SCOPE OF WORK RULE.***

116 *Comment:* Reviewers have broad flexibility and significant responsibility in determining the
117 appropriate scope of work in an appraisal review assignment.

- 118 • *Information that should have been considered by the original appraiser can be used*
119 *by the reviewer in developing an opinion as to the quality of the work under review.*

- 120 • *Information that was not available to the original appraiser in the normal course of*
 121 *business may also be used by the reviewer; however, the reviewer must not use such*
 122 *information in the reviewer's development of an opinion as to the quality of the work*
 123 *under review.*

124 **Compliance with STANDARD 1, 4, 6, 7, or 9 through the Use of Extraordinary Assumption(s)**—The
 125 development of the reviewer's opinion of value requires compliance with STANDARD 1, 4, 6, 7, or 9 as
 126 applicable. The reviewer's use of those items from the work under review that the reviewer concludes are
 127 credible and in compliance with the applicable development standard is based on an extraordinary assumption.
 128 This is because, unless the reviewer actually replicates the steps necessary to develop those items, the reviewer
 129 is assuming the integrity of that work without personal verification. If those assumptions were found to be false,
 130 the reviewer's appraisal-related opinions and conclusions would be affected. As such, this situation constitutes
 131 an extraordinary assumption (refer to requirements for proper application in SR 1-2(f), 4-2(f), 6-2(i), 7-2(f), or
 132 9-2(f) as applicable). Those items not deemed to be credible or in compliance must be replaced with
 133 information or analysis by the reviewer, developed in conformance with STANDARD 1, 4, 6, 7, or 9, as
 134 applicable, to produce a credible value opinion.

135 **Altering the Scope of Work in Developing the Reviewer's Opinion of Value**—In some appraisal review
 136 assignments, the client needs a reviewer's opinion of value to be developed under a different scope of work than
 137 in the original appraisal.

138 If the reviewer's assignment has a different scope of work than does the original work, or if the reviewer relies
 139 on different information not available to, or not used by, the original appraiser, then it is possible that the two
 140 appraisal results could also differ. This does not mean that either set of results is "wrong" per se; in any event,
 141 the reviewer should not use information unavailable to the original appraiser as the basis to discredit the original
 142 appraiser's opinion of value.

143 If there is a difference between the appraiser's opinion of value and the reviewer's opinion of value, the
 144 reviewer should use care to ensure correct identification of the cause of that difference in the appraisal review
 145 process. The reviewer should also use care to not mislead an intended user when providing support for the
 146 reviewer's conclusions in the appraisal review report. This is critical from an enforcement perspective as well as
 147 in a business setting. Incorrectly characterizing the cause of a deficiency can erode the credibility of appraisal
 148 review conclusions and of the reviewer's value opinion.

149 **D. APPRAISAL REVIEW REPORT CONTENT**

150 The reviewer's opinions and conclusions stated in compliance with SR 3-2(d) can vary significantly, depending
 151 on the purpose and intended use of the appraisal review. A reviewer should carefully compose the particular
 152 language stating his or her opinions and conclusions to avoid misleading the user of the appraisal review report
 153 as to the scope of work completed in the assignment and the meaning of the reviewer's stated opinions and
 154 conclusions. Note that any additional information relied upon and the reasoning and basis for the reviewer's
 155 opinion of value must be summarized, in contrast to the other requirements in this section that must only be
 156 stated. Additionally, changes to the report content by the reviewer to support a different value conclusion must
 157 match, at a minimum, the reporting requirements for a Summary Appraisal Report.

ADVISORY OPINION 20

158 **An Appraisal Review Assignment WITHOUT an Opinion of Value**—If the assignment is only to develop an
159 opinion as to the quality of another appraiser’s work, the appraisal review report content must include:

- 160 1. the information set forth in Standards Rules 3-5(a)–(h); and
- 161 2. the reviewer’s certification shown in Standards Rule 3-6.

162 When the appraisal review is only for ascertaining quality, the reviewer should use extreme care to ensure the
163 appraisal review report does not include language that implies the reviewer developed an opinion of value
164 concerning the subject property of the original work. When the reviewer uses language to signify concurrence
165 with the value or a different value opinion, the reviewer has additional appraisal development and reporting
166 obligations.

167 **Illustrations of the Language in an Appraisal Review Report WITHOUT an Opinion of Value**

168 The following are examples of language that might be used in an appraisal review report that does not express
169 an opinion of value and thus does not constitute evidence of an appraisal by the reviewer:

- 170 • “the value opinion stated in the appraisal report is (or is not) adequately supported”
- 171 • “the value conclusion is (or is not) appropriate and reasonable given the data and analyses
172 presented”
- 173 • “the value opinion stated in the report under review was (or was not) developed in compliance
174 with applicable standards and requirements”
- 175 • “the content, analyses, and conclusions stated in the report under review are (or are not) in
176 compliance with applicable standards and requirements”
- 177 • “I reject the value conclusion as lacking credibility due to the errors and/or inconsistencies found”
- 178 • “the value conclusion is not appropriate due to (for example) a significant math error in the Sales
179 Comparison Approach—if calculated properly, the value conclusion would change to \$XXX;
180 however, the reader is cautioned that this solely represents a recalculation and not a different
181 opinion of value by the reviewer”
- 182 • “I accept (or approve) the appraisal report for use by XYZ bank (or agency).”

183 Such language, or language that conveys similar meanings to the intended users of the appraisal review report,
184 relates to the quality of the work under review, including the opinion of value stated in that work, but does not
185 suggest either concurrence or a different opinion of value by the reviewer. It is also important that this language
186 be consistent with the scope of work described in the appraisal review report.

187 **An Appraisal Review Assignment WITH an Opinion of Value**—When the appraisal reviewer develops an
188 opinion as to the quality of another appraiser’s work PLUS the reviewer’s own opinion of value, the appraisal
189 review report content must include:

- 190 1. the information set forth in Standards Rules 3-5(a)–(i); and
- 191 2. the reviewer’s certification shown in Standards Rule 3-6.

192 The appraisal-related content of the appraisal review report, in combination with the content of the original
193 work under review that the reviewer concludes is in compliance with the Standards applicable to that work,
194 must at least match the report content required for a Summary Appraisal Report.

195 The reviewer is not required to replicate or duplicate in the appraisal review report the material in the work
196 under review that the reviewer concludes is in compliance with the Standards applicable to that work. The
197 reviewer can incorporate by reference those portions of the work under review that he or she concludes are in
198 compliance with the applicable Standards by use of an extraordinary assumption.

199 **Illustrations of the Language in an Appraisal Review Report WITH an Opinion of Value**

200 The following are examples of language that signify a value opinion (i.e., either by concurrence or by indication
 201 of a numeric point, a range, or a relationship to a numeric benchmark). These examples DO constitute evidence
 202 of a value opinion (i.e., appraisal) by the reviewer, thereby making the appraisal review one that includes an
 203 appraisal.

- 204 • “I concur (or do not concur) with the value”
- 205 • “I agree (or disagree) with the value”
- 206 • “in my opinion, the value is (the same)”
- 207 • “in my opinion, the value is incorrect and should be \$XXX”
- 208 • “in my opinion, the value is too high (or too low)”

209 Such language, or language that conveys similar meanings to the intended users of the report, represents that the
 210 reviewer has completed the steps required to develop his or her own value opinion. Such language indicates the
 211 reviewer has either concurred with the appraiser’s value opinion in the underlying work, and thus has adopted
 212 that value opinion as his or her own, or has developed a different opinion of value—hence, this (or similar)
 213 language constitutes an opinion of value (i.e., appraisal) by the reviewer. It is also important that this language
 214 be consistent with the scope of work described in the appraisal review report.

215 Note that if a reviewer rejects the value, he or she should use care in how that result is stated. If the language of
 216 such rejection is based on errors or inconsistencies in the original work and does not include any qualifiers that
 217 would relate to a direction in value, it does not imply an appraisal by the reviewer.

218 However, if such rejection is stated in relation to a value or value range, such as indicating a direction in value
 219 (i.e., more than, less than) or to an established benchmark, that language indicates the appraisal review has
 220 taken on the “opinion of value” characteristic of an appraisal. This is an important distinction that must be kept
 221 in mind by the reviewer when composing any language regarding the original appraiser’s opinions or
 222 conclusions. In addition, whichever category such language may fall under, it must also be consistent with the
 223 purpose, scope of work, and intended use of the appraisal review assignment results.

224 The following list summarizes the requirements in a real property appraisal review assignment with the
 225 reviewer’s opinion of value. The sequence of steps completed in this type of assignment is presented in order.

- 226 1. The reviewer develops **opinions and conclusions about the quality** of the work under review.
- 227 2. The reviewer develops **an opinion of value for the subject property** of the work under review.
- 228 3. The reviewer then **communicates the opinions and conclusions** developed in the first two steps in the
 229 report.

ADVISORY OPINION 20

230 The sequence of steps is illustrated in the following table.

APPRAISAL REVIEW THAT INCLUDES THE REVIEWER'S OPINION OF VALUE

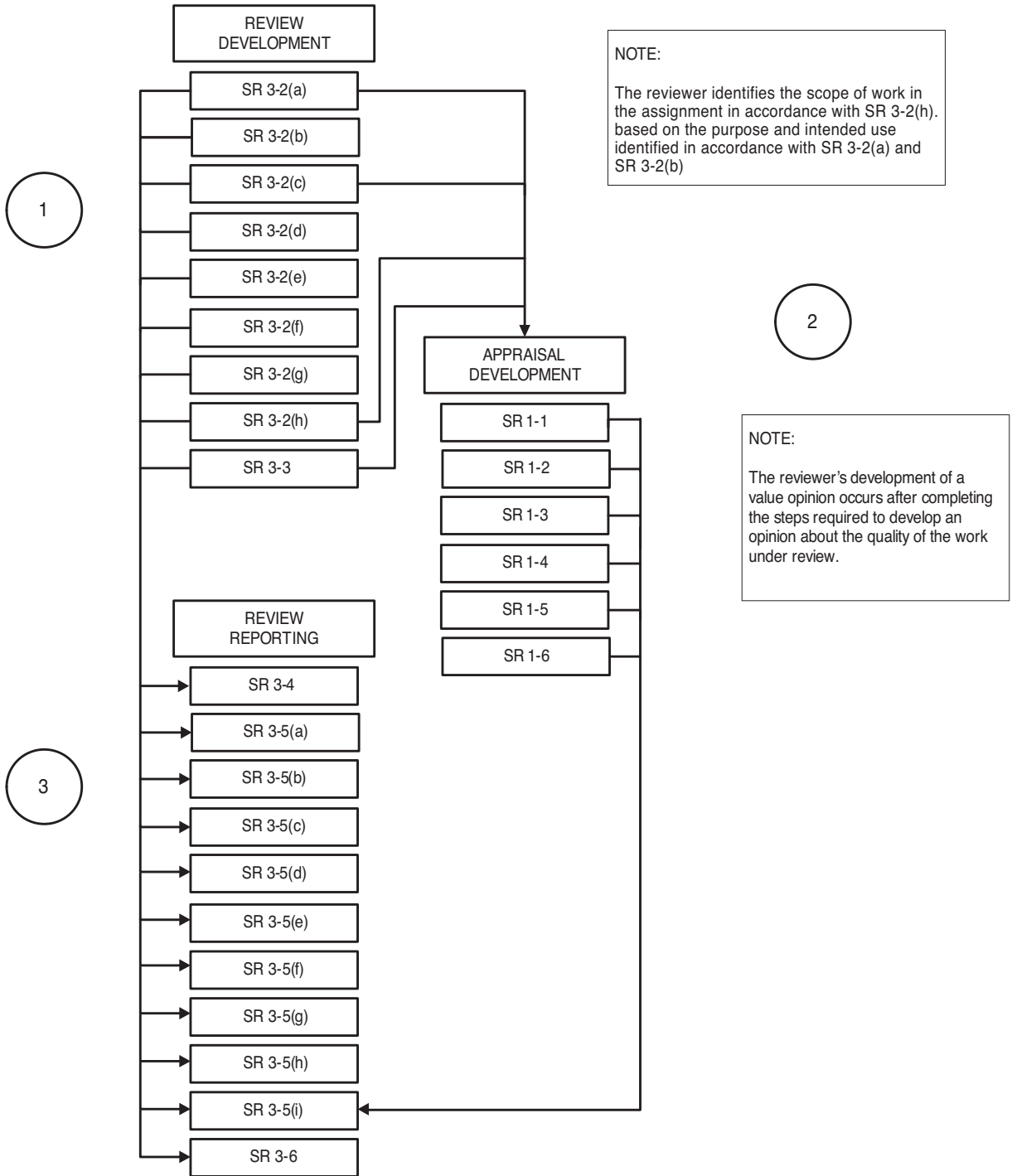

1 **ADVISORY OPINION 21 (AO-21)**

2 *This communication by the Appraisal Standards Board (ASB) does not establish new standards or interpret*
 3 *existing standards. Advisory Opinions are issued to illustrate the applicability of appraisal standards in specific*
 4 *situations and to offer advice from the ASB for the resolution of appraisal issues and problems.*

5 **SUBJECT: USPAP Compliance**6 **APPLICATION: Real Property, Personal Property, Intangible Property**7 **THE ISSUE:**

8 Individuals perform numerous roles within the broad realm of valuation services. Examples include appraisal,
 9 brokerage, auctioning, property management, advocate consulting, appraisal consulting and collecting market
 10 data. Some valuation services are part of appraisal practice and require compliance with USPAP. What are the
 11 USPAP compliance requirements for these various services? More specifically:

- 12 1. When should an individual comply with USPAP?
- 13 2. What is the relationship between Valuation Services and Appraisal Practice?
- 14 3. What does acting “as an appraiser” or performing a service “as an appraiser” mean?
- 15 4. Why does an expectation for an individual to act as an appraiser indicate an obligation to comply
 16 with USPAP?
- 17 5. What are the responsibilities of an appraiser regarding intended user expectations?
- 18 6. What are the USPAP obligations for appraisal practice outside of appraisal, appraisal review, and
 19 appraisal consulting?
- 20 7. What are the USPAP obligations for valuation services outside of appraisal practice?

21 **ADVICE FROM THE ASB ON THE ISSUE:**22 **1. When should an individual comply with USPAP?**

23 The PREAMBLE states that *compliance with USPAP is required when either the service or the appraiser is*
 24 *obligated to comply by law or regulation, or by agreement with the client or intended users.* An obligation to
 25 comply with USPAP is created by law, regulation, or agreement with intended users.¹ In such cases an appraiser
 26 must follow USPAP. The PREAMBLE also states that *when not obligated, individuals may still choose to*
 27 *comply with USPAP.* The ETHICS RULE states that *an individual should comply any time that individual*
 28 *represents that he or she is performing the service as an appraiser.*² An ethical obligation to comply with
 29 USPAP is created by choice, that is, by choosing to represent one’s self as an appraiser.

30 Therefore,

- 31 • When required by law, regulation, or agreement, an individual must comply with USPAP.
- 32 • When choosing to represent oneself as an appraiser, an individual should comply with USPAP.

¹ USPAP gains legal authority through adoption by the various state and federal jurisdictions. Consequently, the legal requirement to follow USPAP is rooted in federal and state laws or regulations.

² The PREAMBLE states that *the appraiser’s responsibility is to protect the overall public trust and it is the importance of the role of the appraiser that places ethical obligations on those who serve in this capacity.* However, the PREAMBLE also states that *USPAP does not establish who or which assignments must comply. Neither The Appraisal Foundation nor its Appraisal Standards Board is a government entity with the power to make, judge, or enforce law.*

33 **2. What is the relationship between Valuation Services and Appraisal Practice?**

34 A key to distinguishing an appraiser’s obligations is understanding the relationship between “valuation
35 services” and “appraisal practice” in USPAP. Appraisal practice is a subset of valuation services.

36 “Valuation services” are *services pertaining to aspects of property value*. Appraisers and others for whom value
37 is an issue provide valuation services. Examples include appraisal, brokerage, auctioning, property
38 management, advocate consulting, appraisal consulting and collecting market data.

39 “Appraisal practice” is defined as *valuation services performed by an individual acting as an appraiser*. Only
40 appraisers may offer services that are considered appraisal practice. Examples include appraisal, appraisal
41 consulting, and collecting market data (acting as an appraiser).

42 Since USPAP obligations apply to those who are acting as appraisers, USPAP applies to appraisal practice.

43 **3. What does acting “as an appraiser” or performing a service “as an appraiser” mean?**

44 An “appraiser” is defined as *one who is expected to perform valuation services **competently and in a manner**
45 **that is independent, impartial, and objective*** (bold added for emphasis). Therefore, an individual “acting as an
46 appraiser” is expected, in part, to be competent in the service being provided. Also, an individual “acting as an
47 appraiser” is expected to provide the service in a manner that is independent, impartial, and objective.
48 Performing a service in a manner that is independent, impartial, and objective is an ethical requirement within
49 USPAP.

50 “Acting as an appraiser” means representing oneself as an appraiser. Many individuals have other professional
51 roles in addition to their appraiser role. For example, some appraisers are also brokers, consultants, or leasing
52 agents. Individuals who have appraiser roles as well as other professional roles must be careful to explain their
53 role in performing a given valuation service (see question #7 below).

54 Law, regulation, agreement, or representation (choice) each prescribes when a valuation service is to be
55 provided by an appraiser as part of appraisal practice. Emphasizing another portion of the definition of an
56 “appraiser” is *one who is **expected to perform valuation services competently and in a manner that is**
57 **independent, impartial, and objective*** (bold added for emphasis). The Comment to the definition goes on to
58 state that the *expectation* [for ethical and competent performance] *occurs when individuals, either by choice or*
59 *by requirement... represent that they comply*. Expectation is the crucial element in determining when one is
60 acting as an appraiser.

61 **4. Why does an expectation for an individual to act as an appraiser indicate an obligation to comply**
62 **with USPAP?**

63 Public trust requires that when an individual is expected to perform with the ethics and competency of an
64 appraiser, he or she will do so. An individual who agrees to perform a valuation service as an appraiser has a
65 duty to comply with the ethics and competency that the public expects from an appraiser. This obligates the
66 individual to comply with USPAP in performing the service.

67 The definition of an appraiser in conjunction with the need for public trust establishes the “expectation” as the
68 basis for the obligation to comply with USPAP.

69 Intended user expectations for valuation services performed in compliance with USPAP are created when an
70 individual represents that he or she is acting as an appraiser in a service. For example, these expectations can
71 arise when an individual advertises or solicits as an appraiser (such as telephone listings, professional
72 directories, business cards, stationery, or office signage), holds appraiser accreditation from a licensing agency,
73 or maintains membership in a professional appraiser organization. An individual’s identification as an appraiser

74 in a given valuation service establishes a justifiable expectation that the valuation service will be performed in
75 compliance with USPAP.

76 In summary, expectation is the basis for determining when an individual providing a valuation service is acting
77 as an appraiser. Because of the need to preserve public trust and confidence in appraisal practice, the
78 expectations of the client and other intended users for ethical and competent performance create an obligation to
79 comply with USPAP.

80 **5. What are the responsibilities of an appraiser regarding intended user expectations?**

81 The appraiser has a professional responsibility to recognize the capacity in which he or she is performing. The
82 responsibility includes inquiry about, and recognition of, the intended users' expectations. When an individual's
83 appraisal expertise and reputation for providing services without bias induce the client or other intended users to
84 select the individual to provide a valuation service, there is a justifiable expectation that the valuation service
85 will be performed in compliance with USPAP.

86 When an individual who acts as an appraiser in some circumstances chooses to provide a valuation service in
87 some other capacity (i.e., not as an appraiser and outside of appraisal practice), he or she must not represent
88 himself or herself to be acting in the capacity of an appraiser. Since choice is an instrument to create USPAP
89 obligations it follows that when an individual has an opportunity to choose the capacity in which he or she will
90 provide a valuation service, he or she is free to provide the valuation service as an appraiser or in some other
91 capacity. However, an individual who is recognized as an appraiser must use great care not to violate the public
92 trust.

93 **6. What are the USPAP compliance obligations for appraisal practice outside of appraisal, appraisal
94 review, and appraisal consulting?**

95 Within appraisal practice, there are some assignments that are addressed by Standards (i.e., STANDARDS 1
96 through 10). The Standards describe the requirements for appraisal, appraisal review, or appraisal consulting
97 assignments.

98 However, STANDARDS 1 through 10 do not apply in the performance of all appraisal practice services.
99 Examples include assignments (performed as an appraiser) to teach appraisal courses, provide sales data, collect
100 market data, analyze specific elements of value (e.g., reproduction cost or functional utility), and develop
101 educational texts. (As defined in USPAP, assignments are performed by an individual acting as an appraiser.
102 Therefore, all assignments fall within appraisal practice.)

103 Assignments to which STANDARDS 1 through 10 do not apply must still comply with the portions of USPAP
104 that apply generally to appraisal practice. These include the DEFINITIONS, PREAMBLE, the ETHICS RULE,
105 the COMPETENCY RULE, and the JURISDICTIONAL EXCEPTION RULE. As a result, such assignments
106 must be provided without bias or accommodation of personal interest by competent appraisers.

107 The RECORD KEEPING RULE applies to appraisal, appraisal review, and appraisal consulting assignments
108 (i.e., STANDARDS 1 through 10). For other assignments, there are no workfile or record keeping requirements
109 in USPAP. The SCOPE OF WORK RULE also applies only to appraisal, appraisal review, and appraisal
110 consulting assignments.

111 **7. What are the USPAP obligations for valuation services outside of appraisal practice?**

112 As previously stated, many individuals have other professional roles in addition to their appraiser role. For
113 example, some appraisers are also attorneys, accountants, brokers, or consultants. USPAP also places an
114 obligation on an individual who sometimes acts as an appraiser even when he or she provides a valuation
115 service in some other capacity – that obligation being not to mislead the users of the valuation service about the
116 capacity in which he or she is acting. The ETHICS RULE states that *an appraiser must not misrepresent his or*

ADVISORY OPINION 21

117 *her role when providing valuation services that are outside of appraisal practice.* If a valuation service is
118 premised on advocacy or compensation arrangements that are contrary to the ETHICS RULE, the valuation
119 service is not consistent with the objectives of USPAP and cannot be performed by the individual acting as an
120 appraiser.

121 An individual who sometimes provides services as an appraiser, but who is currently acting in another role,
122 must ensure that intended users are not misled as to the individual's role in providing that valuation service.
123 This can be accomplished through such means as disclosure, notification, or careful distinction when providing
124 the valuation service as to the individual's role. Additionally, clear representation of the valuation services to be
125 rendered in the engagement communication, scope of work description, or contract, as well as in written and
126 oral correspondence with the client should assist in ensuring intended users are not misled.

127 **Relationships and Application**

128 The relationship between valuation services and appraisal practice can be illustrated as follows.

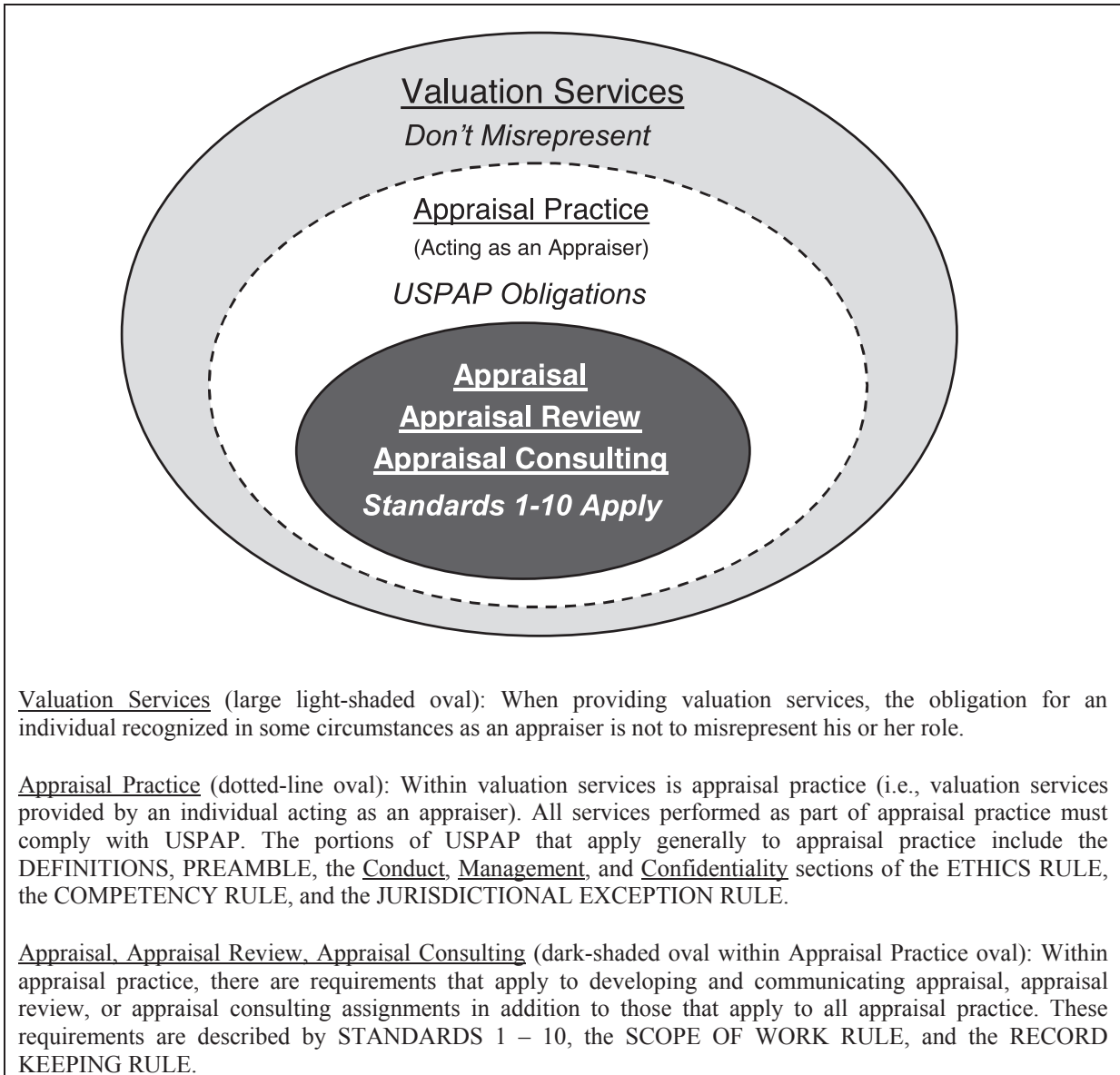

	VALUATION SERVICES		
	Other Roles (e.g. brokerage, property management)	Appraisal Practice	
		Other Services	Appraisal, Appraisal Review & Appraisal Consulting
Pertains to aspects of value	√	√	√
Performed by individual acting as an appraiser		√	√
Obligation to comply with USPAP		√	√
Performance and reporting requirements (STANDARDS 1-10)			√
Record keeping and workfile requirements			√

141 **Summary**

- 142 • An individual must comply with USPAP when required by law, regulation, or agreement.
- 143 • An individual should comply with USPAP when choosing to represent one’s self as an appraiser.
- 144 • Appraisal practice is a subset of valuation services. Since USPAP obligations apply to those who act as
145 appraisers, USPAP applies to appraisal practice.
- 146 • The definition of appraiser and need for public trust establish the factor of “expectation” as the basis for the
147 obligation to comply with USPAP.
- 148 • An individual’s public identification as an appraiser establishes a justifiable expectation that valuation
149 services will be performed in compliance with USPAP. Because of the need to preserve public trust and
150 confidence in appraisal practice, the expectations of the client and other intended users for ethical and
151 competent performance create an obligation to comply with USPAP.
- 152 • The appraiser has a professional responsibility to recognize the capacity in which he or she is performing.
153 The responsibility includes inquiry about, and recognition of, the client’s expectations.
- 154 • When an individual has an opportunity to choose the capacity in which he or she will provide a valuation
155 service, he or she is free to provide the valuation service as an appraiser or in some other capacity.
- 156 • An individual who is recognized as an appraiser must use great care not to violate the public trust. An
157 appraiser acting in another role must ensure that intended users are not misled as to the individual’s role in
158 providing that valuation service.
- 159 • USPAP also places an obligation on an appraiser even when he or she provides a valuation service in some
160 other capacity – that obligation being to not mislead the intended users of the valuation service about the
161 capacity in which he or she is acting.

- 162 • If a valuation service is premised on advocacy, or compensation arrangements that are contrary to the
163 ETHICS RULE, an individual acting as an appraiser cannot perform the valuation service.
- 164 • Within appraisal practice, there are Standards that describe the requirements for developing and
165 communicating appraisal, appraisal review, or appraisal consulting assignments. Appraisers who provide
166 valuation services for which there are no Standards need to comply with the portions of USPAP that apply
167 generally to appraisal practice.
- 168 • The RECORD KEEPING RULE applies to appraisal, appraisal review, or appraisal consulting
169 assignments. For other assignments, there are no USPAP record keeping or workfile requirements.
- 170 • The SCOPE OF WORK RULE applies only to appraisal, appraisal review, and appraisal consulting
171 assignments.

172 **Illustrations**

173 *Brokerage and Appraisal*

- 174 1. Robert Agent is an individual who provides both brokerage and appraisal services. What are Robert’s
175 obligations under USPAP when preparing a broker’s price opinion (BPO)?

176 Answer: Many states’ brokerage and appraiser licensing laws have specific provisions for appraisers
177 who are also brokers. In the absence of such laws, USPAP provides flexibility for brokers/appraisers
178 and others who have multiple professional roles.

179 If providing the service as an agent or broker, USPAP requires only that an appraiser must not
180 misrepresent his or her role. In others words, if Robert was contacted by his client because he is an
181 agent or broker and signing his report as an agent or broker, then Robert need not comply with USPAP
182 except to not misrepresent his role. If Robert is contacted by the client because he is known as an
183 appraiser and is signing his report as an appraiser, then USPAP applies.

184 *Appraisal Review*

- 185 2. Dan Williams is an appraiser. He was asked by a client to perform an “administrative screening review” of
186 an appraisal report to determine if a more thorough review is warranted. The client would like Dan to check
187 the math calculations and determine whether the appraisal report complies with the client’s basic content
188 specifications. What are Dan’s obligations under USPAP?

189 Answer: The client has engaged Dan because of his identification as an appraiser; this clearly creates
190 an expectation by the client that the service will be provided in compliance with USPAP. Therefore,
191 this service is part of appraisal practice; *at a minimum* Dan must comply with the portions of USPAP
192 that apply generally to appraisal practice (i.e., DEFINITIONS, PREAMBLE, the ETHICS RULE, the
193 COMPETENCY RULE, and the JURISDICTIONAL EXCEPTION RULE.

194 Dan must next decide if compliance with STANDARD 3 is required. To do this, Dan must consider the
195 intended use, intended user, and type and definition of value for the assignment. These factors are the
196 basis of Dan’s scope of work decision. If the appropriate scope of work includes *developing or*
197 *communicating an opinion about the quality of another appraiser’s work that was performed as part of*
198 *an appraisal, appraisal review, or appraisal consulting assignment*, then that assignment is by
199 definition an appraisal review. The label placed on the service cannot support acting outside of
200 STANDARD 3. The client may call the assignment an “administrative screening review,” but it is the

ADVISORY OPINION 21

201 extent of the service that defines it.³ Dan must decide, based on the problem to be solved and scope of
202 work, if the assignment is an *appraisal review* as defined by USPAP. If the assignment is an *appraisal*
203 *review*, then Dan must comply with the development and reporting requirements of STANDARD 3.

204 There may be circumstances when Dan is not acting as an appraiser. If Dan acts in other roles, say as a
205 mortgage underwriter, then Dan may be in position to provide the valuation service outside of appraisal
206 practice. If Dan acts outside of appraisal practice, he must ensure that he does not misrepresent his role
207 and that the client and any other intended users do not expect him to act as an appraiser.

208 *Rent Survey*

209 3. A client has asked Mike Black to perform a rent survey. The client owns the Acme Office Building and
210 wants to know if he is charging enough rent. The client asked Mike to perform this work because he knows
211 Mike is an appraiser; therefore, this valuation service is included in appraisal practice and USPAP applies.
212 How can Mike provide this service in compliance with USPAP?

213 Answer: Mike should fully investigate the client's expectations before determining the scope of work
214 for this assignment. Does the client want only to know what rental rates are being charged for other
215 office buildings in the area? If so, this is likely a service for which USPAP has no Standards (i.e.,
216 STANDARDS 1 and 2 when providing real property appraisals). Mike would then be obligated to
217 comply with the portions of USPAP that apply generally to appraisal practice (i.e., DEFINITIONS,
218 PREAMBLE, the ETHICS RULE, the COMPETENCY RULE, and the JURISDICTIONAL
219 EXCEPTION RULE). The development and reporting of the assignment results would be entirely at
220 his discretion, and a workfile would not be required.

221 However, if the client expects Mike to collect rental rate and lease term information and to analyze
222 them to conclude the market rental terms for the Acme Building, this is an appraisal. This assignment
223 is an appraisal because it includes a specific subject property (i.e., the right to use space in the
224 building) and the problem to be solved in the assignment is a value opinion (i.e., the market rental
225 terms for that space). The appraisal assignment should then be completed in compliance with
226 STANDARDS 1 and 2.

227 *Litigation Services*

228 4. Marie Vaughn has a diverse practice with a specialization in litigation services. She commonly aids
229 attorneys in developing cross-examination strategies for expert witness testimony from appraisers. How
230 does USPAP apply to Marie's "litigation services?"

231 Answer: In order to determine Marie's obligation, it is necessary to understand the nature of her role. If
232 she is acting as an appraiser, her litigation services are part of appraisal practice and the ethics and
233 competency requirements of USPAP apply. Marie must comply, at a minimum, with the portions of
234 USPAP that apply generally to appraisal practice. These include the DEFINITIONS, PREAMBLE, the
235 ETHICS RULE, the COMPETENCY RULE, and the JURISDICTIONAL EXCEPTION. As an
236 appraiser, Marie cannot act as an advocate for any party or issue.

237 If Marie's services include providing an opinion of value, she must comply with the appropriate
238 appraisal standards (STANDARDS 1 and 2, 7 and 8, or 9 and 10). If Marie's services include
239 providing an opinion about the quality of another appraiser's work, the appraisal review requirements
240 of STANDARD 3 apply. If the service includes providing analysis, recommendation, or an opinion to

³ The Comment to the definition of appraisal practice states that *the use of other nomenclature for an appraisal, appraisal review, or appraisal consulting assignment (e.g., analysis, counseling, evaluation, study, submission, or valuation) does not exempt an appraiser from adherence to the Uniform Standards of Professional Appraisal Practice.*

241 solve a real property problem where an opinion of value is a component of the analysis leading to the
242 assignment results, then Marie must adhere to the appraisal consulting requirements of STANDARDS
243 4 and 5.

244 On the other hand, if Marie provides litigation services as an advocate, then she is providing a
245 valuation service outside of appraisal practice. When performing services outside of appraisal practice,
246 Marie can act as an advocate and accept contingent compensation. The only USPAP obligation is that
247 she not misrepresent her role. She must use care to distinguish her role from other roles that would
248 carry an expectation of being impartial, objective, and independent, i.e., acting as an appraiser.

249 Marie may provide litigation services by either acting as an appraiser **or** acting as an advocate for the
250 client's cause; however, she must not perform both roles in the same case.

ADVISORY OPINION 22

1 **ADVISORY OPINION 22 (AO-22)**

2 *This communication by the Appraisal Standards Board (ASB) does not establish new standards or interpret*
3 *existing standards. Advisory Opinions are issued to illustrate the applicability of appraisal standards in specific*
4 *situations and to offer advice from the ASB for the resolution of appraisal issues and problems.*

5 **SUBJECT: Scope of Work in Market Value Appraisal Assignments, Real Property**

6 **APPLICATION: Real Property**

7 **THE ISSUE:**

8 How does “market value” affect the scope of work in a real property appraisal assignment?

9 **ADVICE FROM THE ASB ON THE ISSUE**

10 **Relevant USPAP & Advisory References**

- 11 • COMPETENCY RULE
- 12 • SCOPE OF WORK RULE
- 13 • DEFINITIONS section: “Appraisal,” “Intended Use,” “Market Value,” and “Scope of Work”
- 14 • STANDARD 1
- 15 • Statements on Appraisal Standards No. 6 and No. 9

16 **Scope of Work in a Market Value Appraisal**

17 This Advisory Opinion provides guidance that appraisers, users of appraisals, and enforcement bodies can use
18 when making decisions about the scope of work in market value appraisal assignments (called a “market value
19 assignment” or a “market value appraisal” in this Advisory Opinion).

20 Competently determining the scope of work is an essential step in all assignments performed under USPAP. In
21 a real property appraisal assignment, Standards Rules 1-2(a)–(h) set forth eight identification actions or steps
22 that an appraiser must understand and complete in performing any appraisal assignment. Completing the first
23 seven action steps provides support for the eighth step, the appraiser’s scope of work decision.

24 **The Sequence and Relationship of Action Steps Required by SR 1-2 in a Real Property Appraisal**—The
 25 following table illustrates the sequence and relationship of the action steps leading to the appraiser’s scope of
 26 work decision and the steps taken after that decision through to completion of the appraisal process.

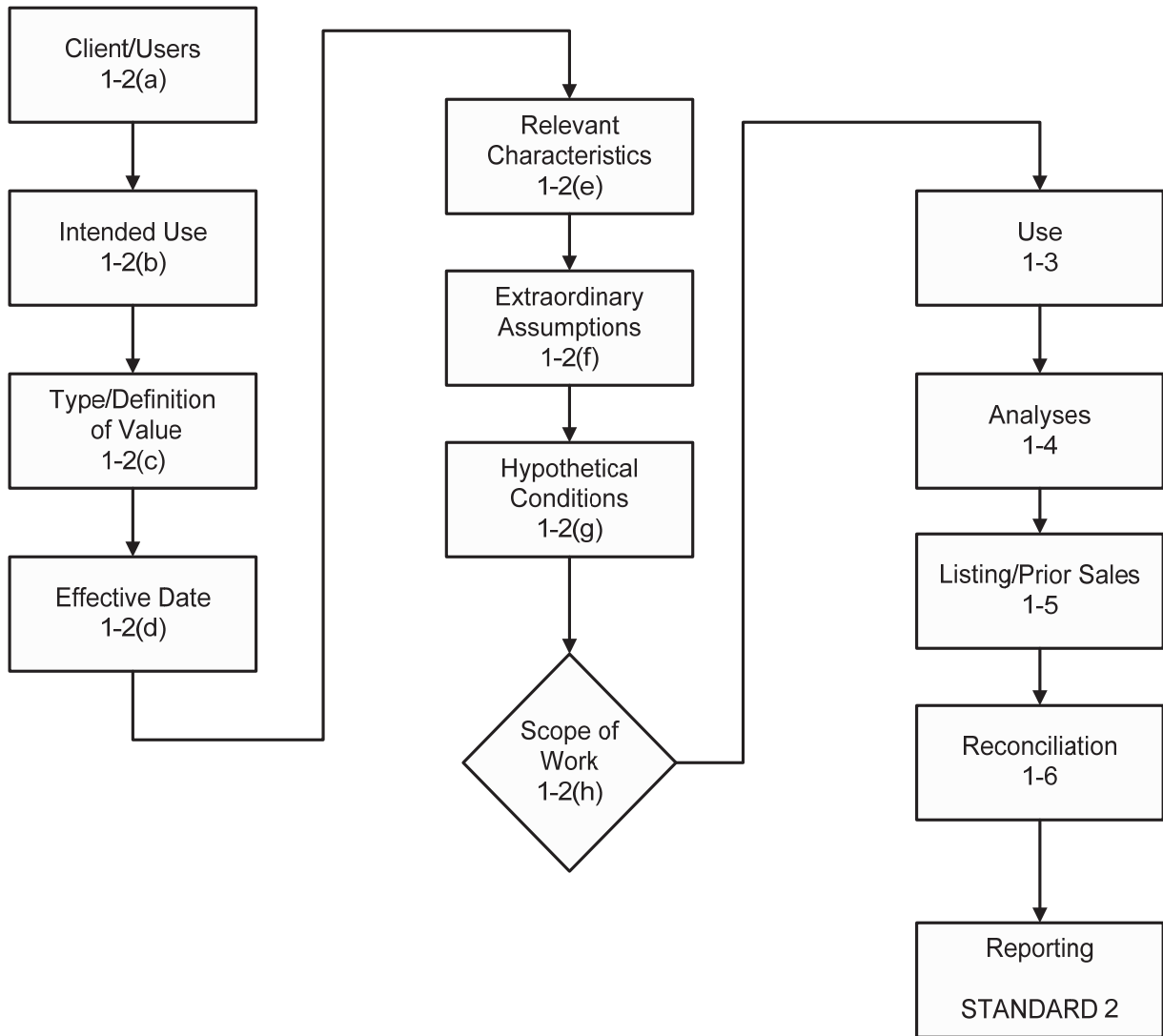

27 It is important to recognize that the action of identifying the client and intended users, the intended use, the type
 28 and definition of value, and the effective date of value (SR 1-2(a)-(d)) affects the appraiser’s decisions as to the
 29 subject’s relevant characteristics, the scope of work, and extraordinary assumptions or hypothetical conditions
 30 (SR 1-2(e)–(h)). The appraiser’s decisions about the last four elements to be identified follow from, and must be
 31 consistent with, factual information identified in the first four elements shown in the table.

32 The sequence illustrated in the table requires the appraiser to begin the decision-making process in the early
 33 stages of an assignment. It also means the appraiser has a burden of proof for conclusions about which property
 34 characteristics are relevant and which are not.

35 **Sequence and Relationship of Action Steps Required by SR 1-2 in a Real Property Appraisal**

36 **Competency and the Scope of Work Decision** - Accomplishing the first four action steps (SR 1-2(a) through
 37 (d)) illustrated in the table provides the basis for deciding which of the property’s characteristics are relevant in

38 the assignment. This information, together with the appraiser's competency (knowledge and expertise) in
39 appraising the specific type of property involved, permits the appraiser to determine whether any extraordinary
40 assumptions or hypothetical conditions are necessary to complete the assignment and to make a reasonable and
41 supportable scope of work decision.

42 It is important to note here that the appraiser's competency in performing similar assignments is a key factor in
43 the scope of work decision. Without competency, the appraiser is not prepared to correctly interpret the
44 information gathered in response to SR 1-2(a)–(e) or to make well reasoned decisions based on that information
45 in response to the requirements set forth in SR 1-2(f)–(h). Moreover, without competency, the appraiser is not
46 aware of or capable of understanding how the information gathered in compliance with SR 1-2(a)–(e) and the
47 conclusions formed in compliance with SR 1-2(f) and (g) affect the decision about which of the analyses steps
48 set forth in Standards Rules 1-3 and 1-4 are necessary in an assignment.

49 Understanding which analyses, methods and techniques are necessary and what data are necessary to correctly
50 complete the analyses is an integral part of the scope of work decision. This decision cannot be made
51 competently without understanding how the "conditions" in a market value definition work together with the
52 other factors identified in compliance with Standards Rule 1-2 to determine what kind of data are relevant and
53 which types of analyses are applicable and necessary in the assignment.

54 General Comment on Market Value Definitions

55 Market value appraisals are distinct from appraisals using other types of value because market value appraisals
56 are based on a market perspective and on a normal or typical premise. These criteria are illustrated in the
57 following definition of *Market Value**, provided here only as an example.

58 **"Market value** means the most probable price which a property should bring in a competitive
59 and open market under all conditions requisite to a fair sale, the buyer and seller each acting
60 prudently and knowledgeably, and assuming the price is not affected by undue stimulus. Implicit
61 in this definition is the consummation of a sale as of a specified date and the passing of title from
62 seller to buyer under conditions whereby:

- 63 1. buyer and seller are typically motivated;
- 64 2. both parties are well informed or well advised and acting in what they consider their own best
65 interests;
- 66 3. a reasonable time is allowed for exposure in the open market;
- 67 4. payment is made in terms of cash in U.S. dollars or in terms of financial arrangements
68 comparable thereto; and
- 69 5. the price represents the normal consideration for the property sold unaffected by special or
70 creative financing or sales concessions granted by anyone associated with the sale."

71 * This example definition is from regulations published by federal regulatory agencies pursuant to Title
72 XI of the Financial Institutions Reform, Recovery, and Enforcement Act (FIRREA) of 1989 between
73 July 5, 1990, and August 24, 1990, by the Federal Reserve System (FRS), National Credit Union
74 Administration (NCUA), Federal Deposit Insurance Corporation (FDIC), the Office of Thrift
75 Supervision (OTS), and the Office of Comptroller of the Currency (OCC). This definition is also
76 referenced in regulations jointly published by the OCC, OTS, FRS, and FDIC on June 7, 1994, and in the
77 *Interagency Appraisal and Evaluation Guidelines*, dated October 27, 1994.

78 The market perspective replaces a user's (e.g., buyer, seller, lender, agent, etc.) perspective that might apply in
79 other appraisals, such as for investment value or insurable value. This market perspective directly affects the
80 scope of work necessary to develop credible opinions and conclusions in market value appraisals. The public's
81 expectation that a market value appraisal reflects only the perspective of the marketplace, and is not affected by
82 such other criteria as an intended user's objectives, is important. Meeting this expectation serves to foster and

83 promote public trust in professional appraisal practice, a fundamental purpose of the *Uniform Standards of*
84 *Professional Appraisal Practice* and one that applies to all work performed under USPAP.

85 A market value appraisal is also based on whatever the “normal” or “typical” conditions are in the marketplace
86 for the property appraised in a time frame that is consistent with the date of value in the appraisal. If the
87 definition of value used in an appraisal contains criteria that are different from those that are “normal” or
88 “typical,” the use of the term “Market Value,” alone, to characterize the assignment result is not appropriate.
89 For example, a value opinion developed to reflect the most probable price in a sale under forced conditions is a
90 forced-sale value and not consistent with the “normal” or “typical” premise to be reflected in a market value
91 appraisal.

92 **Importance of Identifying the Specific Definition of Market Value**—The definition of the value to be
93 developed in an appraisal establishes specific conditions. These conditions impose parameters on the appraisal
94 assignment that are necessary to ensure that the results of the assignment are meaningful in the context of that
95 definition of value.

96 There are many definitions of value, some of which are market value definitions. Other definitions of value
97 appear to be related to market value but are not called market value. For example, it is common practice in
98 appraisals for intended use in employee relocation assignments to use a value definition based on “anticipated
99 sales price” rather than “market value.” The “anticipated sales price” definition contains very specific
100 marketing, property condition, and terms of sale requirements that replace normal or typical market conditions.
101 Thus, while the development process under the specific conditions may appear similar to market value
102 assignments, the result is a value to the property user—the relocation company—under that client’s specific
103 criteria and is not market value.

104 **Importance of Identifying the Source of a Market Value Definition**—Definitions of market value from
105 different sources contain different conditions. Those differences can directly affect the scope of work that is
106 necessary to develop credible assignment results. Each definition is unique, with authority only in a specific
107 jurisdiction or to a specific client group. Therefore, identification of the source for the definition of value to be
108 applied in an assignment is essential.

109 The source must be consistent with the jurisdiction having authority over the transaction in which the appraisal
110 is to be used. For example, using a definition of market value other than the definition specified in regulations
111 published pursuant to Title XI of the Financial Institutions Reform, Recovery, and Enforcement Act of 1989
112 (FIRREA) may invalidate that appraisal for use in a federally related transaction. Likewise, if an appraisal is
113 prepared for use in litigation, using a definition of value other than the definition specified by the court having
114 jurisdiction over the matter being litigated may disqualify that appraisal for use in that court.

115 **How the “Conditions” in a Market Value Definition Affect the Scope of Work Decision**

116 *Market Value* is defined in USPAP as a general concept. But in an appraisal assignment, *Market Value* is
117 defined by a specific jurisdiction (e.g., a court, a regulatory body or public agency with legal authority), or by a
118 client group (e.g., Fannie Mae or Freddie Mac).

119 In a market value appraisal, the appraiser’s conclusions about how best to analyze the market and what data are
120 necessary for the development of credible results must be consistent with the conditions set forth in the specific
121 definition of market value applicable in the assignment. The definition of *market value* included in this
122 Advisory Opinion as an example illustrates the type of conditions that might be part of a specific market value
123 definition used in an assignment.

124 Market value always presumes the transfer of a property as of a certain date, under specific conditions. The
125 “Conditions” stated in market value definitions generally fall into three categories:

- 126 1. the relationship, knowledge, and motivation of the parties (i.e., seller and buyer);

- 127 2. the terms of sale (e.g., cash, cash equivalent, or other terms); and
128 3. the conditions of sale (e.g., exposure in a competitive market for a reasonable time prior to sale).

129 Market value appraisals focus on understanding how buyers and sellers are most likely to respond to a subject
130 property under the conditions stated in a specific value definition. Not all market value definitions contain the
131 same conditions, though most contain a common subset of elements. Experienced appraisers understand the
132 nuances in the various definitions and develop their assignments using data and analyses that match the
133 conditions required by the specific definition used in an appraisal.

134 The “knowledge” referred to in a market value definition is knowledge about the property appraised, about the
135 market for that property, and about alternatives available in the marketplace that the appraiser concludes are
136 reasonable competition for the property appraised.¹

137 An appraiser is expected to be at least as knowledgeable as the typical market participant is about the market for
138 the type of property to be appraised. By completing research and verification steps while performing the
139 assignment, the appraiser is expected to become as knowledgeable about the subject property and its
140 comparables as the typical market participants.

141 **Knowledge of the Subject Property**—Of the three areas typical market participants are presumed to be
142 knowledgeable about (subject, market, and competition), the first area that the appraiser must address is
143 knowledge of the subject property, which is accomplished by gathering and verifying information about the
144 subject property. This action step may or may not require a personal inspection.

145 In a market value assignment, the relevant characteristics (SR 1-2(e)) are those that have a significant impact on
146 the property’s marketability. These features include legal, economic and physical characteristics. The decision
147 as to which characteristics are relevant cannot be made without knowledge of the market in which the property
148 is sold. This is why competency in appraising a specific type of property and knowledge of the subject
149 property’s market are essential in an assignment.

150 Knowing the property’s relevant characteristics also provides the basis for deciding the applicability of an
151 approach to value.

152 **Knowledge of the Market**—The scope of work necessary to ensure an adequate knowledge of the market for
153 the subject property may range from very little (in addition to what the appraiser already knows) to extensive
154 new research. If the subject property is of a type frequently appraised and in a locality where the appraiser
155 regularly provides services, there may be little need for extensive market research beyond confirmation that the
156 data available for analysis is current, adequate, relevant, and credible.

157 However, if the property involved is not of a type regularly appraised by the appraiser or if the market area is
158 not familiar to the appraiser, the extent of research needs to be sufficient for the appraiser to acquire
159 competency. As stated in the COMPETENCY RULE, this can be achieved in several ways (self-study,
160 association with a locally knowledgeable and competent appraiser, etc.).

161 The critically important aspect of this factor in the scope of work decision is to recognize when additional
162 research is necessary. A competent, professional appraiser will not assume knowledge merely for the sake of
163 convenience. Even though the appraiser might be actively involved in appraising a particular type of property in
164 a given locality, self-imposed professional discipline will prompt that individual to ensure that the scope of
165 work includes verification that the market data used in the analyses is credible, relevant, appropriate, adequate,
166 and as current as possible.

¹ See Statement on Appraisal Standards No. 6, *Reasonable Exposure Time in Real Property and Personal Property Opinions of Value*.

167 This is consistent with the requirement stated in SR 1-1(b), which is designed to ensure that the scope of work
168 completed in an appraisal is sufficient to produce credible opinions and conclusions, given the intended use of
169 the appraisal.

170 **Knowledge of Alternatives**—An understanding of market behavior requires a scope of work that includes
171 research and analyses that is sufficient to ensure competent knowledge of the supply and demand relationships
172 that are relevant to the time frame and the type of property involved in the appraisal. In a market value
173 appraisal, this means gathering, verifying, and evaluating data about sales, listings, and failed efforts to sell
174 “competitive” property, as well as more generalized market data.

175 **Conditions of Sale**—A market value appraisal requires research and analysis of market data sufficient to
176 develop a reasonable opinion of exposure time (see the Comment to SR 1-2(c) and Statement on Appraisal
177 Standards No. 6 with the property marketed in whatever manner is typical for that type of property in its
178 locality. An appraiser working in different market areas should guard against presuming that a marketing
179 process common in one area is typical in all areas. For example, in some markets, property is customarily sold
180 through an auction arrangement, while in others professional brokerage is the norm, and in still others so called
181 “for sale by owner” is the typical process. Each process, in a given time period and locality for the type of
182 property involved, can be “normal.” The identification of the marketing process and exposure time requires an
183 understanding of the subject’s market.

184 Market value definitions imply a sale of the property wherein the buyer and seller are “typically motivated.”
185 This condition requires that the level of research in a market value assignment is sufficient to understand the
186 motivations of the buyers and sellers for the sales used in the approaches to value. The motivations that lead to a
187 sale play a critical role in establishing the relevancy or irrelevancy of a sale as a comparable one in an
188 assignment.

189 Analysis of sales data can yield numeric results, but the numbers lack real meaning without an understanding of
190 the market conditions that generated the sales involved. Without an understanding of what the market
191 conditions were at the time of a sale, as well as the conditions of a particular sale, an appraiser cannot
192 reasonably conclude that the sale price, or any element of comparison based on that price, is a reliable indicator
193 of market value.

194 **Subject’s Marketing and Sale History, and Reconciliation**

195 The appraiser’s scope of work decision in a market value appraisal needs to recognize the research and analyses
196 steps that are necessary to comply with the requirements stated in SR 1-5 and SR 1-6. Those requirements have
197 two objectives, both of which are especially important in a market value appraisal.

198 The first is to ensure that the appraiser makes the effort to obtain relevant information about current and recent
199 market activity involving the subject property (SR 1-5(a) and (b)). This due diligence effort is consistent with
200 the requirement stated in Standards Rule 1-1(b). It also serves as a safeguard against confusing the price in a
201 contract (agreement of sale or option) or an offering with market value and as a safeguard against the appraiser
202 being inadvertently involved in an effort to conceal the facts in regard to one or more recent sale transactions.

203 The second is to ensure that the appraiser reconciles the indications of value resulting from the various
204 approaches utilized to arrive at the value conclusion (SR 1-6).

205 **SUMMARY**

206 The scope of work decision is a critical step in any appraisal. That decision must result in a match between the
207 extent of the research and analyses completed in an assignment with the conditions specified in the definition of
208 value used in that assignment.

ADVISORY OPINION 22

209 In a market value appraisal, the appraiser’s scope of work decision carries a burden of proof to support the
210 appraiser’s conclusion about how he or she addresses each “condition” in the market value definition used in
211 the appraisal. The definition includes conditions that often require a high degree of knowledge, competency,
212 and judgment, which are necessary to effectively develop the appraisal process. An appraiser cannot meet his or
213 her obligations in a market value assignment without having competently identified and then completed a scope
214 of work that enables development of credible opinions and conclusions.

1 **ADVISORY OPINION 23 (AO-23)**

2 *This communication by the Appraisal Standards Board (ASB) does not establish new standards or interpret*
 3 *existing standards. Advisory Opinions are issued to illustrate the applicability of appraisal standards in specific*
 4 *situations and to offer advice from the ASB for the resolution of appraisal issues and problems.*

5 **SUBJECT: Identifying the Relevant Characteristics of the Subject Property of a Real Property Appraisal**
 6 **Assignment**

7 **APPLICATION: Real Property**8 **THE ISSUE:**

9 How does an appraiser determine which characteristics of a real property are relevant to its appraisal?

10 **ADVICE FROM THE ASB ON THE ISSUE:**11 **Relevant USPAP & Advisory References**

- 12 • DEFINITIONS, specifically the definitions of
 13 Appraisal: (noun) the act or process of developing an opinion of value; an opinion of value.
 14 ...
 15 Comment: An appraisal must be numerically expressed as a specific amount, as a range
 16 of numbers, or as a relationship (e.g., not more than, not less than) to a previous value
 17 opinion or numerical benchmark (e.g., assessed value, collateral value).
 18
 19 Assignment: 1) an agreement between an appraiser and a client to provide a valuation service;
 20 2) the valuation service that is provided as a consequence of such an agreement.
 21 Real Estate: an identified parcel or tract of land, including improvements if any.
 22 Real Property: the interests, benefits, and rights inherent in the ownership of real estate.
 23 Value: the monetary relationship between properties and those who buy, sell, or use those
 24 properties.
 25
 26 Comment: Value expresses an economic concept. As such, it is never a fact but always
 27 an opinion of the worth of a property at a given time in accordance with a specific
 28 definition of value. In appraisal practice, value must always be qualified for example,
 29 market value, liquidation value, investment value.
 30
 31 • Standards Rule 1-2(e): An appraiser must identify the characteristics of the property that are
 32 relevant to the type and definition of value and intended use of the appraisal, including:
 33 (i) its location and physical, legal, and economic attributes;
 34 (ii) the real property interest to be valued;
 35 (iii) any personal property, trade fixtures, or intangible items that are not real property but are
 36 included in the appraisal;
 37 (iv) any known easements, restrictions, encumbrances, leases, reservations, covenants, contracts,
 38 declarations, special assessments, ordinances, or other items of a similar nature; and
 39 (v) whether the subject property is a fractional interest, physical segment, or partial holding.

40 **The Subject of a Real Property Appraisal Assignment**

41 The subject of a real property appraisal has both physical and legal characteristics. In combination, these
42 characteristics define the subject property and, together with the type and definition of value and intended use of
43 the assignment results, provide the basis for deciding what data and analyses should be included in the scope of
44 work.

45 Appraisers and property owners often discuss a subject property in physical terms, such as *my home, the*
46 *residence, my land, or the building*. However, a physical object, alone, is not what is being appraised.

47 Taken together, the definitions of *real property* and *real estate* provided in USPAP require that the subject of a
48 real property appraisal is a specific ownership of a right (or rights) in identified real estate.

49 The right or rights might be owned in part, as a fractional interest, or in full. Further, real estate can take many
50 forms, such as land, land and improvements, improvements without the underlying land, or an infinite variety
51 that involve one or more of the physical aspects of real estate. Alternatively, a type of property, such as Class A
52 Office Space, does not signify specific ownership rights in identifiable real estate. Consequently, surveys or
53 studies relating to a class of property do not constitute the “subject” of a real property appraisal under
54 STANDARD 1. In such situations, the service provided by completing the survey or study is not an appraisal
55 assignment because there is no “subject property.”

56 Understanding these different characteristics is essential for correct identification of the subject of a real
57 property appraisal and for determining which characteristics of the property are relevant in the assignment.

58 **How the Characteristics of the Subject Affect the Scope of Work Decision**

59 As discussed above, real property can have many different characteristics, each of which can significantly affect
60 the scope of work in an assignment. Consider the following illustrations:

61 1. The subject is the fee simple interest owned in a single-family residence situated on an improved site.
62 These components (the land, the improvements, and the ownership) are, together, the subject property of
63 the appraisal assignment. In this assignment the appraiser is developing and reporting a market value
64 opinion.

65 The scope of work in this assignment should include gathering data about the characteristics of the subject
66 that are significant in the market for this type of property under its highest and best use. Given the
67 characteristics of the subject property, the analysis should include sales of other properties held in fee
68 simple ownership situated in the subject’s market area that are similar to the subject in as many other
69 respects as possible.

70 2. If all of the same characteristics of the property in Illustration No. 1 apply, except that the land is a leased
71 site, the subject property becomes:

- 72 • leasehold interest, if the intended user needs to know the value of the rights in the real estate
73 owned by the lessee in the lease, or
- 74 • leased fee interest, if the intended user needs to know the value of the rights in the real estate
75 owned by the lessor in the lease.

76 Note that the subject real estate (physical asset) was the same, but the ownership interest of the subject
77 changed. The impact of this change on the scope of work and on the relevant data in each assignment is
78 significant. For example, in a market value appraisal:

- 79 • If the subject property is the leasehold interest, the relevant analysis should include sales of
80 leasehold interest properties that are as similar to the subject as possible, both physically and in
81 terms of its lease (cash flow) characteristics.
82 • If the subject is the leased fee interest, the relevant data should include sales of leased fee interest
83 properties with similar physical and cash flow characteristics. The subject lease terms determine
84 whether the improvements' characteristics are significant in this type of assignment. If the lease
85 ends before the improvements reach the end of their economic life, the improvements'
86 characteristics can be important to the appraisal problem. If the tenant must remove the
87 improvements upon termination of the lease, the improvements' characteristics likely have little
88 significance in the assignment.

- 89 3. Next, assume the same subject property characteristics as in Illustration No. 1 but change the ownership to
90 an undivided one-third interest in the fee simple title. The scope of work in this Illustration is significantly
91 different than that in either Illustration No. 1 or No. 2. (See the Comment to Standards Rule 1-4(e)).

92 If available, the most relevant analysis would be of sales of similar fractional interests in similar real estate.
93 In the absence of such sales, the research might extend to secondary sources or other less direct analyses to
94 develop, test, and support the fractional interest value conclusion.

- 95 4. A prospective client is considering a loan secured by a portfolio of properties owned in fee simple by a loan
96 applicant. The real property offered as loan security is an ownership, held by one party, of several nearly
97 identical properties in different locations.

98 In this situation, the appraiser must pay particular attention to the intended use of the assignment results
99 and how that use affects the property configuration that will be relevant in the analyses. This is essential
100 because assignment results must be meaningful to the client and analyses of the market for the subject must
101 reflect the intended use.

102 If the client intends to use the appraisal to secure a single loan secured with all of the properties held by the
103 client's loan applicant, the subject property is the entire holding (i.e., the portfolio). In this situation, the
104 appraiser must include research and analyses to address the impact of all of the subject's individual parts
105 appearing in the market at the same time, to be sold by one owner to one buyer. The intended use drives
106 this configuration of the subject's characteristics.

107 Alternatively, if the same client intended to use the appraisal to secure one loan under loan conditions that
108 would allow each property in the holding to be released (sold) on its own, the assignment is actually for
109 several appraisals communicated in one report or possibly in several reports. In this configuration, each
110 individual property is a subject property to be sold by one seller in the same time frame to (potentially)
111 different buyers. The analyses must still address the potential impact, if any, of having all of the properties
112 in the loan applicant's portfolio on the market at one time but without the necessity of selling to one buyer
113 in one transaction.

114 The intended use of the assignment results alters the characteristics of the subject that are relevant to the
115 appraisal and clearly alters the appropriate scope of work. In the first instance, the relevant data about the
116 subject and about its market must reflect the subject's characteristics as a property portfolio rather than as
117 an individual property within a community. In the latter case, the relevant data must address the relevant
118 characteristics and market conditions for each individual property. Analyzing a portfolio of properties as if
119 each property were a separate element or increment of value when the subject of the assignment is the
120 portfolio fails to recognize distinct differences between the markets for individual properties and portfolios.
121 Specifically, the value of the subject, as a portfolio, is not necessarily the sum of the values for each of the
122 properties in that portfolio; it could be less or it could be more.

- 123 5. A prospective client finances real estate development projects and requests an appraisal for use in a single-
124 family residential tract development financing package. The client needs an opinion of value for the project

125 and values for each of four individual floor plans as if each was a finished property on a typical or so-called
126 “base” lot within the development. The project involves acquisition of finished sites and the construction
127 and sale of finished homes in phases over a period of years. All of the values are to be market value and the
128 effective date of value is to be a current date, all for the intended use of securing the development loan and
129 the take-out loan commitment.

130 It is important to recognize that in this illustration the assignment actually involves five properties: the
131 entire project plus each of the four floor plans. In this case, the subject that is the project includes the land
132 and the entitlements that allow development of the residential tract on the land. Each of the four floor plans
133 becomes a subject under the hypothetical condition that the finished home on the typical or base lot actually
134 exists as a finished property as of a current date of value. The appraiser must then develop and report five
135 appraisals of five different subject properties.

136 For the development loan, the subject’s relevant characteristics are those of the project, not the homes, and
137 the scope of work to analyze the market for the project must address the entire project’s characteristics.

138 For each take-out loan, the relevant subject property is an individual finished home, not the project, and the
139 summation of the value for those individual homes is not meaningful in terms of the value of the project.
140 Indeed, summation of the value of the individual homes to indicate the market value of the project is
141 incorrect development, and reporting such a summation as market value of the project is misleading.

142 The scope of work necessary to analyze the market for an individual home as a subject property is
143 significantly different from that necessary to analyze the market for the project as a subject property.

144 **SUMMARY**

145 Identifying the relevant subject property characteristics, together with the other information gathered in
146 response to Standards Rule 1-2, enables an appraiser to make a sound scope of work decision.

147 Accepting a prospective assignment on the basis of incomplete information can result in a significant mismatch
148 between the scope of work and the valuation problem to be solved in the appraisal assignment. The lack of clear
149 communication with the client before deciding to accept or forego an assignment can lead to an excessive or
150 deficient scope of work. When the scope of work is excessive, appraisers might unnecessarily forego valuation
151 service opportunities. When the scope of work is inadequate or the subject property characteristics are not
152 appropriately analyzed given the intended use of the assignment results, the results are not likely to be credible
153 or meaningful.

154 An appraiser should, by communicating with a prospective client, gather information about the type and
155 definition of value, the intended use, and the effective date of the appraisal, as well as characteristics of the
156 subject of a real property appraisal assignment, before deciding which characteristics are relevant and the
157 appropriate scope of work.

ADVISORY OPINION 24 (AO-24)

This communication by the Appraisal Standards Board (ASB) does not establish new standards or interpret existing standards. Advisory Opinions are issued to illustrate the applicability of appraisal standards in specific situations and to offer advice from the ASB for the resolution of appraisal issues and problems.

SUBJECT: Normal Course of Business

APPLICATION: Real Property, Personal Property

THE ISSUE:

Standards Rules 1-5 and 7-5 require an appraiser to analyze certain information about the subject property if the information is *available to the appraiser in the normal course of business*. How does one determine the “normal course of business” for a given assignment?

BACKGROUND:

The analysis that is required in SR 1-5 and SR 7-5 promotes a certain degree of due diligence on the part of the appraiser. Appropriate due diligence increases public trust in the appraisal profession. The intent is to ensure that the research of past sales and current listings, options, or agreements of sale of the subject property is sufficient to promote public trust, without creating undue hardship on the appraiser.

The availability of the data necessary to comply with the requirements in SR 1-5 and SR 7-5 varies greatly. In some situations, this data is available from multiple sources. In other instances, sales and listing data is not readily available.

The “normal course of business” is controlled to a large degree by the scope of work in a specific assignment. Differences in intended use, intended users, the type and definition of value, or other factors can dramatically alter the scope of work. Therefore, the “normal course of business” for one assignment might not be the “normal course of business” for a seemingly similar assignment.

ADVICE FROM THE ASB ON THE ISSUE:**Relevant USPAP & Advisory References**

- The following USPAP references are applicable when ascertaining the “normal course of business” in an assignment:
 - Standards Rules 1-2(h) and 7-2(h)
 - Standards Rules 1-5 and 7-5
- For additional advice, refer to Advisory Opinion 1, *Sales History*

General Comments

The “normal course of business” is determined by the actions of an appraiser’s peers and by the expectations of parties who are regularly intended users for similar assignments; it is not any one appraiser’s practices or any one appraisal firm’s policies.

To fully understand this concept one must examine the definitions of “Scope of Work” and “Appraiser’s Peers.”

“Scope of Work” is addressed in the SCOPE OF WORK RULE, Standards Rules 1-2(h) and 7-2(h), and is defined in USPAP as:

the type and extent of research and analyses in an assignment

ADVISORY OPINION 24

38 Researching the subject's sales history is an aspect of the scope of work. The Comment to the Scope of Work
39 Acceptability section in the SCOPE OF WORK RULE states:

40 *The scope of work is acceptable when it meets or exceeds:*

- 41 • *the expectations of parties who are regularly intended users for similar assignments; and*
- 42 • *what an appraiser's peers' actions would be in performing the same or a similar assignment.*

43 Therefore, it is not the work habits of an individual appraiser that define the "normal course of business" in an
44 assignment. Rather, it is the requirements of the Standards Rules measured against the actions of the appraiser's
45 peers and the expectations of parties who are regularly intended users for similar assignments.

46 "Appraisers Peers" is defined as:

47 *other appraisers who have expertise and competency in a similar type of assignment.*

48 In addition to the concept of "normal course of business" in an assignment, an appraiser has the obligation to
49 perform research and analysis appropriate to the intended use of the assignment. Standards Rules 1-1(b) and 7-
50 1(b) state:

51 *In developing a[n] ...appraisal, an appraiser must:*

52 *not commit a substantial error of omission or commission that significantly affects an appraisal...*

53 The Comments to these Standards Rules state, in part:

54 *Diligence is required to identify and analyze the factors, conditions, data, and other information that*
55 *would have a significant effect on the credibility of the assignment results.*

56 Illustrations

57 1. A reviewer noted that a real property appraisal report did not include an analysis of a sale of the
58 subject real property that had occurred six months prior to the effective date of the appraisal. The sale
59 was reported in the local Multiple Listing Service (MLS), which is available to appraisers in the area
60 and to which most area appraisers subscribe. When contacted about the matter, the appraiser stated that
61 he did not subscribe to the MLS, and checking that data source was not within his normal course of
62 business. Is this an appropriate response?

63 Answer: No. The fact that the individual appraiser does not subscribe to this data source does not
64 excuse the lack of analysis. Since most appraisers in the market area do subscribe, and informed
65 market participants would be aware of this and expect this level of diligence, the appraiser's lack
66 of research and analysis did not reflect the normal course of business in *this* market.

67 2. A real property appraiser is engaged to appraise a property that is located in a rural area. Sales prices
68 are a matter of public record, but the records are not computerized, and personal analysis of the public
69 records requires a trip to the municipal building and a great deal of time searching records. Local
70 officials will not provide this information over the telephone. Most appraisers in the area analyze sales
71 data by using information provided by a local on-line data provider and quarterly sales reports that are
72 mailed out by the local jurisdiction. In this situation, what action is necessary by the appraiser to
73 comply with the requirement to analyze the subject's sales history?

74 Answer: In this case, the normal course of business is to use the information from the local data
75 provider and the quarterly sales reports. If a trip to the municipal building does not reflect the
76 typical actions of most other appraisers in this market for this property type, or the expectations of

77 clients for this specific type of assignment, then it is not required as part of the research and
78 analysis in this assignment.

79 3. A personal property appraiser is engaged to appraise a painting by a well-known artist for estate tax
80 purposes. Neither the heirs nor the executor of the estate could locate the documentation for the
81 purchase by the decedent, even though the painting had been bought less than six months before the
82 appraisal was ordered. However, the sale was widely reported, both in newspapers and trade
83 publications, since the painting had been purchased at public auction and at a price that set a new high
84 for that artist's work. The appraiser used sales of other paintings by the same artist to support the final
85 opinion of value, but not the recent sale of the subject property, stating in the report that the
86 documentation was not available. Does this comply with the sales history requirements of Standards
87 Rule 7-5?

88 Answer: No. This would not comply with the requirements of Standards Rule 7-5. Competent
89 fine art appraisers would research relevant sections of newspapers and trade magazines and likely
90 keep files or create databases of significant transactions. Therefore, this appraiser should have
91 known at least the details of the sale that had been made public in the press.

92 4. During an appraisal assignment, the appraiser was informed by the owner that the subject property was
93 listed for sale on a prominent Internet site. The appraiser did no additional research, and in the
94 appraisal report indicated only that the property was listed for sale. Does this comply with the
95 requirements of USPAP?

96 Answer: No. The appraiser must analyze the current listing and report the findings within the
97 appraisal report. Since the listing was placed on the Internet, where it would be available to the
98 general public, it would be available to the appraiser in the normal course of business.

ADVISORY OPINION 25

1 **ADVISORY OPINION 25 (AO-25)**

2 *This communication by the Appraisal Standards Board (ASB) does not establish new standards or interpret*
3 *existing standards. Advisory Opinions are issued to illustrate the applicability of appraisal standards in specific*
4 *situations and to offer advice from the ASB for the resolution of appraisal issues and problems.*

5 **SUBJECT: Clarification of the Client in a Federally Related Transaction**

6 **APPLICATION: Real Property**

7 **THE ISSUE:**

8 The appraisal rules adopted by the Federal Financial Institutions Regulatory Agencies in August 1990 to
9 comply with Title XI of the Financial Institutions Reform, Recovery, and Enforcement Act of 1989 (FIRREA)
10 impose a requirement on regulated institutions that “if an appraisal is prepared by a fee appraiser, the appraiser
11 shall be directly engaged by the regulated institution or its agent.....”¹

12 In some cases, however, a property owner might directly engage the services of an appraiser for one intended
13 use, but later desire to use the appraisal report in a federally related loan transaction. This and other similar
14 scenarios lead to the question: “Does an appraiser have an obligation to ensure that his or her services are
15 directly engaged by a federally regulated financial institution?”

16 **ADVICE FROM THE ASB ON THE ISSUE:**

17 **Relevant USPAP & Advisory References**

- 18 • DEFINITIONS, specifically those of “client,” “intended user,” and “intended use.”
- 19 • The ETHICS RULE.
- 20 • SCOPE OF WORK RULE, which requires an appraiser to determine an appropriate scope of work
21 to produce credible assignment results including all assignment conditions.
- 22 • Standards Rules 1-2(a) and 1-2(b), which require an appraiser to identify the client, intended user,
23 and intended use.
- 24 • Standards Rule 2-1(a), which requires an appraiser to clearly and accurately set forth the appraisal
25 in a manner that is not misleading.
- 26 • Statement on Appraisal Standards No. 9, which addresses intended use and intended users in an
27 assignment.
- 28 • Advisory Opinion 26 which covers readdressing (transferring) a report to another party.
- 29 • Advisory Opinion 27 which addresses appraising the same property for a new client.
- 30 • Advisory Opinion 30, *Appraisals for Use by a Federally Regulated Financial Institution*

¹ National Credit Union Administration – 2 CFR 722.5(b)
Federal Reserve System – 12 CFR 225.65(b)
Federal Deposit Insurance Corporation – 12 CFR 323.5(b)
Office of the Comptroller of the Currency – 12 CFR 34.45(b)
Office of Thrift Supervision – 12 CFR 564.5(b)

31 **Comments**

32 USPAP requires an appraiser to identify the intended use and intended users in an appraisal assignment. USPAP
 33 also requires that an appraiser not be misleading in the marketing of their services (see Management section of
 34 the ETHICS RULE). Advisory Opinion 30 provides guidance on the applicability of federal regulations and
 35 USPAP obligations when performing appraisals for use by a federally regulated financial institution.

36 In order to not be misleading when contacted by a prospective client the appraiser's obligation is one of proper
 37 disclosure. Before an appraiser accepts an assignment knowing the intended use of the appraisal is, or may be,
 38 for a federally related transaction by a federally regulated financial institution, it is that appraiser's
 39 responsibility to disclose to the prospective client that the lender or its agent is required to directly engage the
 40 appraiser. The appraiser should also disclose to the prospective client that it is unethical for the appraiser to later
 41 "readdress" or otherwise change the report to indicate a federally regulated financial institution was the client
 42 when the appraisal was performed for another party (see AO-26 titled *Readdressing [Transferring] a Report to*
 43 *Another Party* and AO-27, titled *Appraising the Same Property for Another Client* for related advice on this
 44 issue).

45 If the client still wishes to proceed with the appraisal after the appraiser has properly fulfilled these disclosure
 46 obligations the appraiser can accept the assignment. It would be prudent to recite disclosures in the engagement
 47 letter and in the report. (Also refer to SMT-9 for additional information relating to intended use and intended
 48 users).

49 **Illustrations:**

50 1. Homeowner Susan Daly contacts appraiser John Hunt to perform an appraisal of her residence. She is
 51 considering refinancing and wants to determine the amount of equity in the residence before completing a
 52 loan application. Assuming the refinancing would be a federally related transaction at a federally regulated
 53 financial institution, what is John's responsibility to this potential client?

54 Answer: Before John accepts this assignment, it is his responsibility to disclose to Susan that a lender
 55 or its agent is required to directly engage the services of an appraiser in a federally related transaction
 56 and should not accept his appraisal report. If Susan still wants to engage John, his disclosure allows
 57 him to accept the assignment.

58 2. A buyer of a commercial building contacts appraiser Jane Johnson about appraising the property for
 59 financing. The buyer explains that he will likely be providing the report to an insurance company that is
 60 interested in financing the property. The insurance company has no problem with the buyer being the
 61 client, as long as the insurance company is identified as an intended user in this assignment. However, the
 62 buyer says that he may also make application to his local bank, a federally regulated financial institution.
 63 Can Jane accept this assignment? If so, does she have any disclosure obligations?

64 Answer: Jane has an obligation to disclose to the buyer that the federally regulated financial institution
 65 should not accept her appraisal report because a lender or its agent is required to directly engage the
 66 services of an appraiser in a federally related transaction. If the buyer still wants to engage Jane, her
 67 disclosure allows her to accept the assignment.

ADVISORY OPINION 26

1 **ADVISORY OPINION 26 (AO-26)**

2 *This communication by the Appraisal Standards Board (ASB) does not establish new standards or interpret*
3 *existing standards. Advisory Opinions are issued to illustrate the applicability of appraisal standards in specific*
4 *situations and to offer advice from the ASB for the resolution of appraisal issues and problems.*

5 **SUBJECT: Readdressing (Transferring) a Report to Another Party**

6 **APPLICATION: Real Property, Personal Property, and Intangible Property**

7 **THE ISSUE:**

8 After an assignment has been completed and the report has been delivered, an appraiser may be asked to
9 “readdress” (transfer) the report to another party. Does USPAP allow an appraiser to “readdress” (transfer) a
10 report by altering it to indicate a new recipient as the client or additional intended user when the original report
11 was completed for another party?

12 **ADVICE FROM THE ASB ON THE ISSUE:**

13 **Relevant USPAP & Advisory References**

- 14 • The Confidentiality and Conduct sections of the ETHICS RULE.
- 15 • Standards Rules such as 1-2(a) and 1-2(b); 7-2(a) and 7-2(b); and 9-2(a), which require an
16 appraiser to identify the client, intended users, and intended use.
- 17 • Standards Rules such as 2-1(a), 8-1(a), 10-1(a), which require an appraiser to clearly and
18 accurately set forth the appraisal in a manner that is not misleading.
- 19 • SCOPE OF WORK RULE, which requires an appraiser to ascertain whether other laws or
20 regulations apply to the assignment in addition to USPAP.
- 21 • Statement on Appraisal Standards No. 9, which requires the appraiser to identify and disclose the
22 client and intended users and the intended use in an appraisal, appraisal review, or appraisal
23 consulting assignment.
- 24 • Statement on Appraisal Standards No. 10, which describes applicability of USPAP in federally
25 related transactions.
- 26 • Advisory Opinion 25, which covers clarification of the client in a federally related transaction.
- 27 • Advisory Opinion 27, which addresses appraising the same property for a new client.

28 **Comments**

29 No. Once a report has been prepared for a named client(s) and any other identified intended users and for an
30 identified intended use, the appraiser cannot “readdress” (transfer) the report to another party.

31 USPAP defines the Client as:

32 *the party or parties who engage, by employment or contract, an appraiser **in a specific assignment***
33 *(bold added for emphasis).*

34 *Comment: The client may be an individual, group, or entity, and may engage and*
35 *communicate with the appraiser directly or through an agent.*

36 Assignment is defined as:

37 *1) an agreement between an appraiser and a client to provide a valuation service; 2) the valuation*
38 *service that is provided as **a consequence of such an agreement.** (bold added for emphasis).*

39 Intended Use is defined as:

40 *the use or uses of an appraiser's reported appraisal, appraisal review, or appraisal consulting*
41 *assignment opinions and conclusions, as identified by the appraiser based on communication with the*
42 *client **at the time of the assignment** (bold added for emphasis).*

43 Intended User is defined as:

44 *the client and any other party as identified, by name or type, as users of the appraisal, appraisal*
45 *review, or appraisal consulting report by the appraiser on the basis of communication with the client **at***
46 ***the time of the assignment** (bold added for emphasis).*

47 Identification of the client, any other intended users, and the intended use are key elements in all assignments.
48 Because these identifications drive the appraiser's scope of work decision, as well as other elements of the
49 assignment, they must be determined **at the time of the assignment**. They cannot be modified after an
50 assignment has been completed. See Statement on Appraisal Standards No. 9 for further clarification.

51 **Illustrations:**

52 Question #1

53 An appraiser was engaged by Client A to appraise a property. The appraiser delivered the appraisal report to
54 Client A. The client has decided not to pursue the transaction that generated the need for the appraisal report.
55 The appraiser is contacted by Client B. Client B requests that the original report be readdressed (transferred) by
56 replacing Client A's name with Client B's name in the report. Is this acceptable?

57 Answer: No. Simply changing the client name on the report cannot change or replace the original
58 appraiser-client relationship that was established with Client A. Therefore, this action is misleading.

59 Question #2

60 How can this circumstance be handled according to Standards?

61 Answer: The appraiser can consider Client B's request as a new assignment. In so doing, the appraiser may
62 establish a new appraiser-client relationship with Client B and appraise the property for this new client.
63 Important considerations, i.e., confidential information and other factors are further addressed in AO-27 –
64 "Appraising the Same Property for a New Client".

65 Question #3

66 Why might Client B want their name on the report that was completed for Client A?

67 Answer: Client B may want to establish an appraiser-client relationship because it provides all the rights,
68 obligations and liabilities such a relationship places on the appraiser.

69 A prudent method to establish an appraiser-client relationship is to have a written engagement letter or
70 contract with any client at the time of the assignment.

ADVISORY OPINION 27

1 **ADVISORY OPINION 27 (AO-27)**

2 *This communication by the Appraisal Standards Board (ASB) does not establish new standards or interpret*
3 *existing standards. Advisory Opinions are issued to illustrate the applicability of appraisal standards in specific*
4 *situations and to offer advice from the ASB for the resolution of appraisal issues and problems.*

5 **SUBJECT: Appraising the Same Property for a New Client**

6 **APPLICATION: Real Property, Personal Property, and Intangible Property**

7 **THE ISSUE:**

8 Situations often arise in which appraisers who have previously appraised a property are asked by a different
9 party to appraise the same property. In some instances this request arises very soon after the first appraisal; in
10 others, it may be months or years later. Under what circumstances can an appraiser accept an assignment to
11 appraise a property for a prospective client when that appraiser has previously completed an appraisal of the
12 same property for another client?

13 **ADVICE FROM THE ASB ON THE ISSUE:**

14 **Relevant USPAP & Advisory References:**

- 15 • Conduct section of the ETHICS RULE
- 16 • Confidentiality section of the ETHICS RULE.
- 17 • Statement on Appraisal Standards No. 9, which addresses intended use and intended users in an
18 assignment.
- 19 • Advisory Opinion 25 which covers clarification of the client in a federally related transaction.
- 20 • Advisory Opinion 26 which addresses reappraising/transferring a report to another party.

21 **Comments:**

22 Accepting the assignment from the subsequent prospective client is not prohibited by USPAP, assuming
23 appropriate disclosure is made to the client before being engaged and any existing confidential information is
24 handled properly.

25 The part of the Conduct section of the ETHICS RULE that is pertinent to this matter includes the following:

26 ***If known prior to accepting an assignment, and/or if discovered at any time during the assignment, an appraiser***
27 ***must disclose to the client, and in the subsequent report certification:***

28 *any services regarding the subject property performed by the appraiser within the three year*
29 *period immediately preceding acceptance of the assignment, as an appraiser or in any other*
30 *capacity.*

31 *Comment:* *Disclosing the fact that the appraiser has previously appraised the property is*
32 *permitted except in the case when an appraiser has agreed with the client to keep the mere*
33 *occurrence of a prior assignment confidential. If an appraiser has agreed with a client not to*
34 *disclose that he or she has appraised a property, the appraiser must decline all subsequent*
35 *assignments that fall within the three year period.*

36 Several parts of the Confidentiality section of the ETHICS RULE are pertinent to this matter.

37 *An appraiser must not disclose: (1) confidential information or (2) assignment result: to anyone other than*
38 *the client;*

39 An appraiser cannot disclose the results of a particular assignment, performed for a particular client, to anyone
 40 other than those designated by that client. However, an understanding of the definitions of *assignment*,
 41 *assignment results*, and *client* are key to a complete understanding of this requirement.

42 *Assignment – 1) an agreement between an appraiser and a client to provide a valuation service; 2) the*
 43 *valuation service that is provided as a consequence of such an agreement.*

44 *Client – the party or parties who engage, by employment or contract, an appraiser in a specific*
 45 *assignment.*

46 *Comment: The client may be an individual, group, or entity, and may engage and*
 47 *communicate with the appraiser directly or through an agent.*

48 *Assignment Results – an appraiser’s opinions and conclusions developed specific to an assignment*

49 As can be seen in the definitions, both the client and the assignment results are specific to an assignment. If
 50 there is a new potential client, valuation services performed for that new client would constitute a new
 51 assignment and the assignment results would be specific to that new assignment. Therefore, acceptance and
 52 performance of the new assignment to appraise the same property would not be considered revealing the first
 53 client’s assignment results to the second client, even if the value conclusions were the same. It should be noted
 54 that the value conclusion could easily be different if the effective date or the scope of work changed in any
 55 manner. It should also be noted that USPAP requires the appraiser to provide an unbiased opinion of value to
 56 each client.

57 **Obtaining a Release:**

58 As a matter of business practice, some appraisers request a release from a prior client before accepting an
 59 assignment to appraise the same property for a new client or to disclose the assignment for the second client to
 60 the first client. However, USPAP does not require this. Also, appraisers should be aware that, in some cases,
 61 informing a client about the existence of another client and the fact that the property was appraised for that
 62 other client may not be compliant with the portion of the Confidentiality section of the ETHICS RULE, which
 63 states:

64 *An appraiser must protect the confidential nature of the appraiser-client relationship.*

65 **Confidential Information:**

66 In all assignments the appraiser must comply with the Confidentiality section of the ETHICS RULE with
 67 respect to the handling of confidential information. Confidential information is defined in USPAP as:

68 *information that is either*

- 69 • *identified by the client as confidential when providing it to an appraiser and that is not available*
- 70 *from any other source; or*
- 71 • *classified as confidential or private by applicable law or regulation*

72 The Confidentiality section of the ETHICS RULE states:

73 *An appraiser must be aware of, and comply with, all confidentiality and privacy laws and*
 74 *regulations applicable in an assignment.*

75 *An appraiser must not disclose: (1) confidential information; or (2) assignment results to anyone other*
 76 *than the client, persons specifically authorized by the client, state appraiser regulatory agencies, third*
 77 *parties as may be authorized by due process of law, and a duly authorized professional peer review*
 78 *committee except when such disclosure to a committee would violate applicable law or regulation.*

79 If a prior assignment included any confidential information, its disclosure to a different client or intended user
80 would violate the ETHICS RULE if the information were still classified as confidential information. This
81 includes the requirement to comply with all confidentiality and privacy laws and regulations.

82 **Client Expectations:**

83 At times, an appraiser's client may believe that his or her legitimate business intent could be harmed by that
84 appraiser providing an appraisal of the subject property of that assignment to another client. In such cases, the
85 client and the appraiser may stipulate in their service agreement the conditions under which the appraiser may
86 or may not appraise the same subject property. A client involved in litigation may stipulate that the appraiser
87 cannot appraise a subject property for the opposing party in that litigation. As another example, if an appraiser
88 is providing the value of a property to a client who is planning to sell that property in an auction, the appraiser
89 and client may agree that the appraiser will not appraise the same property for a party planning to participate in
90 the bidding process.

91 **Illustrations:**

92 **Example A – Litigation**

93 An appraiser performs an appraisal for a client involved in litigation and then is requested to appraise the same
94 property for the opposing party. Is accepting the assignment for the second client prohibited by USPAP?

95 No, assuming appropriate disclosure is made to the client and confidential information is handled
96 correctly. However, there are common business practices in such circumstances. Often, the opposing
97 parties each hire an appraiser to appraise the subject property. If the opposing parties do not plan to
98 hire one appraiser jointly, each party could make it a part of the agreement between the appraiser and
99 the client (the engagement letter or contract) that the appraiser is not to appraise the property for
100 anyone representing the opposing side of the legal action.

101 In the absence of such an agreement between the client and the appraiser, the appraiser should make
102 appropriate disclosure to the client and consider the presence of confidential information. The
103 knowledge of confidential information may prevent the appraiser from accepting the second
104 assignment. The appraiser must decline the second assignment if:

- 105 1) the appraiser used confidential information in performing the first assignment;
106 2) that information would not be available from any other source; and
107 3) credible results cannot be derived without the use of this confidential information.

108 However, the appraiser may accept the second assignment, making sure to not disclose any
109 confidential information from the original assignment to the second client, if

- 110 1) the information is available from another source (meaning it is not *confidential information*, as
111 defined); or
112 2) the *confidential information* is not material to deriving credible assignment results, and
113 3) the client agrees to engage the appraiser after the appraiser makes the appropriate disclosure.

114 However, the appraiser must ensure that confidential information is not disclosed, even if it has no
115 impact on the assignment results (such as the litigation strategy of attorneys representing the first
116 client).

117 **Example B – Competing Banks**

118 If an appraiser has appraised a property for Bank A and then is approached by Bank B to appraise the same
119 property, does USPAP prohibit acceptance of the second assignment?

120 No, assuming disclosure is made to the client and confidential information is handled correctly. This
121 constitutes a second assignment, a new client and a new agreement between a client and an appraiser.

1 **ADVISORY OPINION 28 (AO-28)**

2 *This communication by the Appraisal Standards Board (ASB) does not establish new standards or interpret*
3 *existing standards. Advisory Opinions are issued to illustrate the applicability of appraisal standards in specific*
4 *situations and to offer advice from the ASB for the resolution of appraisal issues and problems.*

5 **SUBJECT: Scope of Work Decision, Performance, and Disclosure**

6 **APPLICATION: Real Property, Personal Property, Intangible Property**

7 **THE ISSUE:**

8 The SCOPE OF WORK RULE states:

9 *For each appraisal, appraisal review, and appraisal consulting assignment, an appraiser must:*

- 10 1. *identify the problem to be solved;*
11 2. *determine and perform the scope of work necessary to develop credible assignment results;*
12 *and*
13 3. *disclose the scope of work in the report.*

14 How are the requirements in the SCOPE OF WORK RULE incorporated into the process of developing and
15 reporting assignment results?

16 **ADVICE FROM THE ASB ON THE ISSUE**

17 **Problem Identification**

18 Problem identification is the beginning point of every assignment. The appraiser must gather and analyze the
19 information needed to properly recognize the appraisal, appraisal review, or appraisal consulting problem to be
20 solved. The information necessary for problem identification is presented in each Standard that addresses the
21 development process for an appraisal, appraisal review, or appraisal consulting assignment. For example,
22 Standards Rules 1-2, 6-2, 7-2 and 9-2 provide the assignment elements that must be defined and analyzed in
23 order to identify the problem to be solved in an appraisal assignment. These assignment elements include the:

- 24 • client and any other intended users;
25 • intended use of the appraiser's opinions and conclusions;
26 • type and definition of value;
27 • effective date of the appraiser's opinions and conclusions;
28 • subject of the assignment and its relevant characteristics; and
29 • assignment conditions.

30 Identifying the problem to be solved is required in order to make critical judgments in determining the
31 appropriate scope of work. Therefore, the assignment elements necessary for problem identification in an
32 appraisal, appraisal review, or appraisal consulting assignment also serve as reference points in determining
33 whether the scope of work performed was appropriate to provide credible assignment results.¹

34 Additionally, proper identification of the problem to be solved is required for compliance with the
35 COMPETENCY RULE, which states:

36 *The appraiser must determine, prior to accepting an assignment, that he or she can perform the*
37 *assignment competently. Competency requires (1) the ability to properly identify the problem to be*

¹ See Advisory Opinion 29, *An Acceptable Scope of Work*.

38 *addressed; (2) the knowledge and experience to complete the assignment competently; and (3)*
39 *recognition of, and compliance with, laws and regulations that apply to the appraiser or to the*
40 *assignment.*

41 One of the assignment elements that affects the scope of work is assignment conditions. Some assignment
42 conditions are not a matter of choice, such as an inability to inspect a property because it has been destroyed.
43 Other assignment conditions are a matter of choice, such as a client's request to perform a desktop appraisal of
44 machinery and equipment to reduce fees.

45 **Determining and Performing the Scope of Work**

46 USPAP recognizes that the appropriate scope of work may differ significantly for different assignments; the
47 SCOPE OF WORK RULE provides flexibility in determining the scope of work. The competency necessary to
48 determine an appropriate scope of work within the allowed flexibility resides with the appraiser. Therefore,
49 while it is common and reasonable for the client to provide input to the appraiser regarding a desired scope of
50 work, the responsibility for determining the appropriate scope of work resides with the appraiser.

51 The flexibility and responsibility are linked in the SCOPE OF WORK RULE when it states:

52 *Appraisers have broad flexibility and significant responsibility in determining the appropriate scope of*
53 *work for an appraisal, appraisal review, and appraisal consulting assignment.*

54 This responsibility is described when the SCOPE OF WORK RULE states:

55 *The appraiser must be prepared to demonstrate that the scope of work is sufficient to produce credible*
56 *assignment results.*

57 The client, for example, might request that the appraiser include, or exclude, specific inspections, data
58 collection, or analysis in the scope of work. The appraiser may accept an assignment with these types of
59 assignment conditions provided that the assignment results are credible in the context of the intended use. The
60 SCOPE OF WORK RULE addresses this issue in the Scope of Work Acceptability section:

61 *An appraiser must not allow assignment conditions to limit the scope of work to such a degree that the*
62 *assignment results are not credible in the context of the intended use.*

63 *An appraiser must not allow the intended use of an assignment or a client's objectives to cause the*
64 *assignment results to be biased.*

65 Determining the appropriate scope of work requires judgment. This judgment rests on the appraiser's
66 identification of the assignment elements and understanding of what is required to solve the identified problem.
67 In many assignments, experienced appraisers are able to make this judgment about the appropriate scope of
68 work quickly because they have performed many assignments addressing a similar problem to be solved
69 (assignment with similar assignment elements). In other assignments, the determination of the appropriate scope
70 of work may require more analysis by the appraiser because the problem to be solved has certain unusual
71 characteristics. In yet other assignments, the appraiser may begin with a planned scope of work but in the
72 course of the assignment find that the planned scope of work must be modified in order to produce credible
73 assignment results.

74 The SCOPE OF WORK RULE recognizes that the scope of work actually performed may differ from the scope
75 of work initially planned, when it states:

76 *Determining the scope of work is an ongoing process in an assignment. Information or conditions*
77 *discovered during the course of an assignment might cause the appraiser to reconsider the scope of*
78 *work.*

79 **Disclosing the Scope of Work Performed**

80 The SCOPE OF WORK RULE explains that proper disclosure of the scope of work:

81 *...is required because clients and other intended users rely on the assignment results.*

82 The Rule also states that:

83 *The report must contain sufficient information to allow intended users to understand the scope of work*
84 *performed.*

85 An appraiser must disclose research and analyses not performed when such disclosure is necessary for intended
86 users to understand the report properly and not be misled.

87 These disclosure requirements apply to the scope of work performed, rather than the scope of work initially
88 planned by the appraiser. The appraiser must disclose the type and extent of research and analyses that were
89 actually completed in the development process. Additionally, the information required to allow intended users
90 to understand the scope of work may include disclosure of research and analyses not performed. There is no
91 requirement for the scope of work description to be in a particular or separate section of the report.

92 **Illustrations:**

93 1. A real property appraiser is engaged to appraise the market value of a twelve-unit apartment building. The
94 appraiser initially decided that the scope of work should include the inspection of two of each of the three
95 unit types (studio, one- and two-bedroom). In the course of conducting the inspection, the property
96 manager had a key for only one of the two-bedroom units; thus the appraiser was not able to inspect one of
97 the two-bedroom units as planned.

98 The scope of work, which includes the degree of inspection, was affected in this assignment because of
99 lack of access. If the appraiser decides that she has sufficient information to produce credible assignment
100 results, the appraiser can complete the appraisal based on the inspection completed. The report would
101 include a description of the scope of work performed, stating that five units had been inspected.

102 2. A personal property appraiser was engaged to appraise four sets of china. The intended use of the report
103 was for litigation regarding an estate. The client requested that all pieces of each set of china be inspected,
104 since one cause of action claimed that several pieces were damaged.

105 When the appraiser contacted the estate's administrator to arrange for inspection, he was told that one set of
106 china was in storage and could not be retrieved until after the Court's deadline for the submission of expert
107 reports.

108 In this case, assignment conditions have changed the appraiser's scope of work. The appraiser may not
109 have sufficient information to produce credible assignment results in the context of the intended use. The
110 appraiser should consult with the client on the proper course of action. The appraiser may alter the scope of
111 work to include the appraisal of only the three sets of china available for inspection or use an extraordinary
112 assumption regarding the condition of the fourth set.

113 3. A business appraiser is appraising a closely held business enterprise with real property and personal
114 property assets. In the course of the assignment, the appraiser's research indicates that the market for the
115 company's product is declining and management's projections are not supported. Therefore, the appraiser
116 believes the company might be worth more in liquidation than as a going concern, which would make
117 performance of the work addressed in Standards Rule 9-3 necessary for credible assignment results.

118 The scope of work must be modified because of what the appraiser learned in the course of performing
 119 research and analyses.

120 4. A real property appraiser is contacted by a potential client to appraise an occupied manufacturing facility.
 121 The client requests that the occupants not be disturbed by a property inspection. Additionally, the client
 122 requests that the cost approach be performed in the appraisal of the building. These requests are
 123 assignment conditions and will be part of the appraiser’s identification of the problem to be solved and
 124 determination of the appropriate scope of work.

125 Accepting and completing this assignment requires the appraiser to:

- 126 • Determine that the client’s assignment conditions do not limit the scope of work to such a degree
 127 that assignment results are not credible in the context of the intended use;
- 128 • Gather information on relevant characteristics by means other than inspection and/or use
 129 extraordinary assumptions;
- 130 • Include a cost approach in the scope of work, even if this approach is not otherwise necessary for
 131 credible assignment results; and
- 132 • Properly reconcile the applicability or suitability of the cost approach in arriving at the value
 133 conclusion.

134 5. A real property appraiser accepted an assignment to appraise a three-unit residential property. The intended
 135 use of the appraisal was for mortgage financing. The client requested that the appraiser not verify the legal
 136 status (e.g., compliance with zoning, building codes, use permits) of the three units with municipal
 137 officials.

138 The appraiser withdrew from the assignment because she concluded that the client’s assignment condition
 139 limited the scope of work to such a degree that assignment results are not credible in the context of the
 140 intended use. The use of an extraordinary assumption about the legal use of the property would not produce
 141 credible assignment results in the context of the mortgage financing use.

142 6. An appraiser was engaged to appraise a one-unit residence. Based on the appraiser’s identification of the
 143 appraisal problem, the appropriate scope of work was determined to include development of the sales
 144 comparison approach and cost approach. However, at the time of the inspection the appraiser discovered
 145 that the property was not a one-unit, but instead a three-unit property.

146 Based on this new information, the appraiser re-considered the appraisal problem and the appropriate scope
 147 of work. The change in relevant property characteristics for the subject property significantly changes the
 148 appropriate scope of work; the initially planned scope of work is no longer suitable and would not produce
 149 credible assignment results. The type of data to be researched and the type of analysis to be applied
 150 changed when the property type changed from a single-unit to a three-unit.

151 A new appraisal problem requires reexamination of the scope of work. The appropriate scope of work for
 152 the new appraisal problem includes an income approach, and the cost approach is not necessary for credible
 153 assignment results.

154 The appraiser should consult with the client since the appraisal problem has changed.

1 **ADVISORY OPINION 29 (AO-29)**

2 *This communication by the Appraisal Standards Board (ASB) does not establish new standards or interpret*
3 *existing standards. Advisory Opinions are issued to illustrate the applicability of appraisal standards in specific*
4 *situations and to offer advice from the ASB for the resolution of appraisal issues and problems.*

5 **SUBJECT: An Acceptable Scope of Work**

6 **APPLICATION: Real Property, Personal Property, Intangible Property**

7 **THE ISSUE:**

8 The SCOPE OF WORK RULE states that an appraiser's scope of work is acceptable when it meets or exceeds:

- 9 • *the expectations of parties who are regularly intended users for similar assignments; and*
10 • *what an appraiser's peers' actions would be in performing the same or a similar assignment.*

11 What makes an assignment similar?

12 Who are an appraiser's peers?

13 Must an acceptable scope of work satisfy both benchmarks?

14 **ADVICE FROM THE ASB ON THE ISSUE**

15 **Similar Assignments**

16 Assignment elements define and characterize the problem to be solved in appraisal, appraisal review, and
17 appraisal consulting assignments. The assignment elements necessary for proper identification of the appraisal
18 problem are addressed in the applicable Standards Rules (i.e., SR 1-2, SR 3-2, SR 4-2, SR 6-2, SR 7-2 and SR
19 9-2). The applicability of Standards Rules depends on the type of asset being appraised (real property, tangible
20 personal property, or intangible property including business interests) and the type of assignment (appraisal,
21 appraisal review, real property appraisal consulting).

22 Assignments are similar when the assignment elements used to identify the appraisal problem are comparable.
23 Assignment elements include such things as the intended use, intended users, type and definition of value,
24 effective date, relevant characteristics of the subject property, and assignment conditions.

25 The information gathered about the assignment elements is used by the appraiser to identify the problem to be
26 solved and determine an acceptable scope of work. The greater the commonality among assignment elements,
27 the more similarity there is between assignments.

28 **An Appraiser's Peers**

29 USPAP defines Appraiser's Peers as:

30 *other appraisers who have expertise and competency in a similar type of assignment.*

31 To be an appraiser's peer for a particular assignment, one must have the competency to address the appraisal
32 problem presented in that assignment. This includes the knowledge and experience to:

- 33 • properly identify the appraisal, appraisal review, or appraisal consulting problem to be solved;
34 • determine the type and extent of research and analyses to include in the development process; and
35 • perform the required research and analyses properly.

36 Because assignments can require different types of expertise and competency, it is possible to be considered an
 37 appraiser's peer for some assignments, but not for others. Identifying an appraiser's peer is always done in the
 38 context of a particular assignment.

39 Within appraisal practice there are three disciplines (real property, tangible personal property, and intangible
 40 property including business interests), and within those disciplines there are many areas of specific expertise.
 41 An appraiser can have a focused area of expertise and competency or a wide variety of expertise and
 42 competency. Merely holding the same type or level of credential does not make one an appraiser's peer.

43 Determining if an individual is an appraiser's peer requires examining the individual's expertise regarding each
 44 of the elements that define the assignment. For example, solely having expertise in appraising the same type of
 45 property is not sufficient to make someone an appraiser's peer.

46 **Application**

47 The scope of work is acceptable when it leads to credible assignment results. The SCOPE OF WORK RULE
 48 establishes two benchmarks for measuring the acceptability of the scope of work, both of which need to be met.
 49 The scope of work is acceptable when it meets or exceeds **both** (1) the expectations of parties who are regularly
 50 intended users for similar assignments; and (2) what an appraiser's peers' actions would be in performing the
 51 same or a similar assignment. An acceptable scope of work must satisfy both benchmarks.

52 **Illustrations:**

53 1. An appraiser has been engaged to perform an "exterior only" appraisal of a single-family home for a
 54 potential home equity loan. Another appraiser has been asked to appraise a single-family home in the same
 55 development for an FHA loan. Since the subject properties are similar, would the assignments require the
 56 same scope of work?

57 No. The subject of the assignment and its relevant characteristics is just one of several assignment
 58 elements that define an appraisal problem. Because of critical differences in the intended use and the
 59 appraisal problem to be solved, the scope of work that is acceptable for the first assignment would not
 60 be acceptable for the second assignment. For example, an appraisal performed for an FHA loan is
 61 subject to additional inspection requirements.

62 2. A state certified general appraiser is appraising a highly specialized industrial facility, and is concerned that
 63 the assignment is so complex that many appraisers who are knowledgeable about industrial property would
 64 not be qualified to judge whether or not the scope of work was appropriate. Who would be considered the
 65 appraiser's peers in this assignment?

66 The appraiser's peers for this assignment would be other appraisers competent to complete a similar
 67 assignment. If special expertise is required, other state certified general appraisers without the required
 68 expertise and knowledge would not be the appraiser's peers for this assignment. Identifying appraisers
 69 with expertise and competency in appraising similar complex property types or unusual intended uses
 70 may require seeking appraisers from other geographic areas.

71 3. A business appraiser is engaged to value a 25% minority interest in the equity of a small privately held
 72 company for estate tax reporting purposes. The standard of value is fair market value as defined in the tax
 73 regulations. The engagement requires that a second appraiser, meeting the definition of an appraiser's peer,
 74 be retained to review the work and to opine on the value of the subject interest. Another appraiser is
 75 experienced in valuing companies in the same industry, but typically appraises them for purposes of sale,
 76 valuing 100% of the equity and has never performed appraisals of minority interests for estate tax reporting
 77 purposes. Is this other appraiser an appraiser's peer for this assignment?

ADVISORY OPINION 29

78 No. Part of problem identification for a business appraisal includes identification of the extent to which
79 the subject interest contains elements of ownership control. Part of the appraisal process includes
80 analyzing the effect on value, if any, of the extent to which the interest appraised contains elements of
81 ownership control. Individuals who meet the definition of appraiser's peers would need to have
82 expertise and competency in valuing minority interests. Additionally, the fact that the second appraiser
83 has not performed appraisals for the same intended use could also render him or her to not be a peer in
84 this assignment.

85 4. An appraiser has agreed to complete an assignment in the next two days. While conducting research, the
86 appraiser discovers that the primary data source for the assignment, a regional computer database, is off-
87 line and will not be available for three days. What is the appropriate course of action?

88 If an appraiser is unable to perform research that the appraiser's peers would conduct and intended
89 users would expect, the appraiser must modify the assignment to allow time for the research to be
90 conducted, or withdraw from the assignment.

ADVISORY OPINION 30 (AO-30)

This communication by the Appraisal Standards Board (ASB) does not establish new standards or interpret existing standards. Advisory Opinions are issued to illustrate the applicability of appraisal standards in specific situations and to offer advice from the ASB for the resolution of appraisal issues and problems.

SUBJECT: Appraisals for Use by a Federally Regulated Financial Institution**APPLICATION: Real Property****THE ISSUE:**

In order to comply with Title XI of the Financial Institutions Reform, Recovery, and Enforcement Act of 1989 (FIRREA), the federal financial institutions regulatory agencies (“agencies”)¹ of the United States have adopted appraisal regulations and guidelines. These laws, regulations and guidelines are established to protect federally insured depository institutions and include the requirement that appraisals be prepared in compliance with the *Uniform Standards of Professional Appraisal Practice* (USPAP).

What are an appraiser’s obligations when performing a real property appraisal for use by a federally regulated financial institution?

ADVICE FROM THE ASB ON THE ISSUE**Recognition of Assignment Conditions**

USPAP creates an obligation for appraisers to recognize and adhere to applicable assignment conditions. The appraiser’s identification of the intended use and intended users drives the applicable assignment conditions. The relevant laws and agencies’ appraisal regulations and guidelines are assignment conditions for real property appraisals for use by a federally regulated financial institution. These assignment conditions include, but are not limited to, the following:

- Laws, principally Title XI of the Financial Institutions Reform, Recovery, and Enforcement Act of 1989 (FIRREA);
- Regulations, primarily the following agency appraisal regulations:
 - Office of the Comptroller of the Currency (OCC) 12 CFR 34, Subpart C;
 - Federal Reserve Board (FRB) 12 CFR 225, Subpart G;
 - Federal Deposit Insurance Corporation (FDIC) 12 CFR 323;
 - Office of Thrift Supervision (OTS) 12 CFR 564; and
 - National Credit Union Administration (NCUA) 12 CFR 722.
- Guidelines provided in the agencies’ bulletins and issuances, including documents such as:
 - *Interagency Appraisal and Evaluation Guidelines*;
 - *Independent Appraisal And Evaluation Function*;
 - *Frequently Asked Questions on Residential Tract Development Lending*;
 - *The 2006 Revisions to Uniform Standards of Professional Appraisal Practice*; and
 - *Frequently Asked Questions on the Appraisal Regulations and the Interagency Statement on Independent Appraisal and Evaluation Functions*.

¹ Office of the Comptroller of the Currency (OCC), Federal Reserve Board (FRB), Federal Deposit Insurance Corporation (FDIC), Office of Thrift Supervision (OTS), and the National Credit Union Administration (NCUA)

ADVISORY OPINION 30

37 The guidelines identified in this Advisory Opinion are subject to change. Appraisers are cautioned to
38 communicate with their client on the current guidance that is applicable in a given assignment. Reference can be
39 made to the website of the applicable federal financial institutions regulatory agency for these documents and
40 more information on current bulletins and applicable issuances.

41 USPAP Applicability

42 A client that is a federally regulated financial institution expects compliance with the applicable regulations and
43 guidelines. An appraiser's obligations are established in the course of considering and accepting an assignment.
44 Appraisers must recognize and adhere to assignment conditions that apply in an assignment to satisfy the
45 following USPAP requirements:

- 46 1. The PREAMBLE requires that appraisers develop and communicate assignment results in a manner that is
47 meaningful and not misleading.
- 48 2. The ETHICS RULE requires that appraisers perform assignments ethically and competently..
- 49 3. The COMPETENCY RULE requires appraisers to provide competent service, including the specific
50 requirement to recognize and comply with applicable laws and regulations.
- 51 4. In developing assignment results, the SCOPE OF WORK RULE requires appraisers to determine, perform,
52 and disclose the scope of work necessary to produce credible assignment results. Determining the
53 appropriate scope of work requires identification of the problem to be solved, which includes identification
54 of assignment conditions.

55 The scope of work is acceptable when it meets or exceeds the expectations of parties who are regularly
56 intended users for similar assignments. Upon accepting an assignment, an appraiser is obligated to
57 competently satisfy the applicable assignment conditions.

- 58 5. Standards Rule 1-1(a) is an extension of the COMPETENCY RULE that specifically requires that *the*
59 *appraiser be aware of, understand, and correctly employ those recognized methods and techniques that are*
60 *necessary to produce a credible appraisal.*
- 61 6. Standards Rules 2-1(a) and 2-1(b) require that each written appraisal report (a) *clearly and accurately set*
62 *forth the appraisal in a manner that will not be misleading;* and (b) *contain sufficient information to enable*
63 *intended users of the appraisal to understand the report properly.*
- 64 7. STANDARD 2 also requires that report content be consistent with the intended use of the appraisal.

65 Use of the JURISDICTIONAL EXCEPTION RULE is not appropriate because none of the requirements in the
66 agencies' appraisal laws and regulations preclude compliance with USPAP.

67 Appraisers must identify and consider the intended use and intended users in an assignment to understand their
68 USPAP development and reporting obligations. The agencies' appraisal regulations and guidelines contain
69 assignment conditions that are part of competent performance when they apply in an assignment. Therefore,
70 compliance with USPAP requirements for proper development and reporting require adherence to those
71 assignment conditions that apply in an assignment.

72 **Failure to Adhere to Assignment Conditions**

73 Failure to recognize and adhere to applicable assignment conditions violates one or more of the USPAP
74 requirements previously identified.

- 75 • An appraiser who represents that an assignment is or will be completed in compliance with applicable
76 assignment conditions and who then knowingly fails to comply with those assignment conditions
77 violates the ETHICS RULE.
- 78 • An appraiser who unintentionally fails to comply with or fails to recognize those assignment
79 conditions violates the COMPETENCY RULE.
- 80 • An appraiser who fails to develop assignment results in accordance with the assignment conditions
81 necessary for credible assignment results violates the SCOPE OF WORK RULE and STANDARD 1.
- 82 • An appraiser who fails to report assignment results in accordance with the assignment conditions that
83 are necessary to enable intended users to understand the report properly violates STANDARD 2.

84 **Obligations for Appraisers Performing Appraisals for Use by a Federally Regulated Financial Institution**

85 Note: All quotations in this section are from the agencies’ appraisal regulations.² The quoted text is only a
86 portion of the complete regulations, and the applicable regulations should be reviewed in their entirety.

87 **Appraiser Independence**

88 The agencies’ appraisal regulations state, in part:

89 “If an appraisal is prepared by a staff appraiser, that appraiser must be independent of the lending,
90 investment, and collection functions and not involved, except as an appraiser, in the federally related
91 transaction, and have no direct or indirect interest, financial or otherwise, in the property. If the only
92 qualified persons available to perform an appraisal are involved in the lending, investment, or
93 collection functions of the regulated institution, the regulated institution shall take appropriate steps to
94 ensure that the appraisers exercise independent judgment. Such steps include, but are not limited to,
95 prohibiting an individual from performing an appraisal in connection with federally related
96 transactions in which the appraiser is otherwise involved and prohibiting directors and officers from
97 participating in any vote or approval involving assets on which they performed an appraisal.”

98 “If an appraisal is prepared by a fee appraiser, the appraiser shall be engaged directly by the regulated
99 institution or its agent, and have no direct or indirect interest, financial or otherwise, in the property or
100 the transaction.”

101 “A regulated institution also may accept an appraisal that was prepared by an appraiser engaged
102 directly by another financial services institution, if:

- 103 (i) The appraiser has no direct or indirect interest, financial or otherwise, in the property or the
104 transaction; and
- 105 (ii) The regulated institution determines that the appraisal conforms to the requirements of this subpart
106 and is otherwise acceptable.”

² Office of the Comptroller of the Currency – 12 CFR 34.45(b), Federal Reserve Board – 12 CFR 225.65(b), Federal Deposit Insurance Corporation – 12 CFR 323.5(b), Office of Thrift Supervision – 12 CFR 564.5(b), National Credit Union Administration - 12 CFR 722.5(b)

ADVISORY OPINION 30

107 For more information on these requirements and related USPAP obligations see Advisory Opinion 25,
108 *Clarification of the Client in a Federally Related Transaction* and Advisory Opinion 26, *Readdressing*
109 *(Transferring) a Report to Another Party*.

110 **Appraisal Development and Reporting**

111 The agencies' appraisal regulations state, in part:

112 "For federally related transactions, all appraisals shall, at a minimum:

- 113 (a) Conform to generally accepted appraisal standards as evidenced by the Uniform Standards of
114 Professional Appraisal Practice (USPAP) promulgated by the Appraisal Standards Board of the
115 Appraisal Foundation (1155 15th Street, Suite 1111, NW., Washington, DC 20005), unless
116 principles of safe and sound banking require compliance with stricter standards;
- 117 (b) Be written and contain sufficient information and analysis to support the institution's decision to
118 engage in the transaction;
- 119 (c) Analyze and report appropriate deductions and discounts for proposed construction or renovation,
120 partially leased buildings, nonmarket lease terms, and tract developments with unsold units;
- 121 (d) Be based upon the definition of market value as set forth in this subpart; and
- 122 (e) Be performed by State licensed or certified appraisers in accordance with requirements set forth in
123 this subpart."

124 **Market Value Definition**

125 The agencies' appraisal regulations state, in part:

126 "*Market value* means the most probable price which a property should bring in a competitive and open
127 market under all conditions requisite to a fair sale, the buyer and seller each acting prudently and
128 knowledgeably, and assuming the price is not affected by undue stimulus. Implicit in this definition is
129 the consummation of a sale as of a specified date and the passing of title from seller to buyer under
130 conditions whereby:

- 131 (1) Buyer and seller are typically motivated;
- 132 (2) Both parties are well informed or well advised, and acting in what they consider their own best
133 interests;
- 134 (3) A reasonable time is allowed for exposure in the open market;
- 135 (4) Payment is made in terms of cash in U.S. dollars or in terms of financial arrangements comparable
136 thereto; and
- 137 (5) The price represents the normal consideration for the property sold unaffected by special or
138 creative financing or sales concessions granted by anyone associated with the sale."

139 **Commonly Asked Questions**

140 1. How do the assignment conditions that apply to appraisals for use by a federally regulated financial
141 institution affect the appraiser's scope of work and report content?

142 An appraiser accepting an assignment to be performed under the agencies' appraisal regulations and
143 guidelines is obligated to complete that assignment in a manner that adheres to the applicable appraisal
144 regulations and guidelines.

145 2. What is a "real estate-related financial transaction"?

146 The term is defined in Title XI of FIRREA and the agencies' appraisal regulations as "any transaction
147 involving —

148 (1) The sale, lease, purchase, investment in or exchange of real property, including interests in
149 property, or the financing thereof; or

150 (2) The refinancing of real property or interests in real property; or

151 (3) The use of real property or interests in property as security for a loan or investment, including
152 mortgage-backed securities."

153 3. What is a "federally related transaction"?

154 The term is defined in Title XI of FIRREA as "any real estate-related financial transaction which —

155 (A) a federal financial institutions regulatory agency or the Resolution Trust Corporation engages
156 in, contracts for, or regulates; and

157 (B) requires the services of an appraiser."

158 The agencies' appraisal regulations define when the services of an appraiser are required. The
159 agencies' appraisal regulations also list specific categories of transactions that do not require the
160 services of an appraiser.

161 4. Do the agencies' appraisal regulations apply to FHA, VA, Fannie Mae, Freddie Mac, Farmer Mac, or Sallie
162 Mae?

163 FHA, VA, Fannie Mae, Freddie Mac, Farmer Mac and Sallie Mae are not under the supervision of the
164 federal financial institutions regulatory agencies and therefore are not subject to their appraisal
165 regulations.

ADVISORY OPINION 31

1 **ADVISORY OPINION 31 (AO-31)**

2 *This communication by the Appraisal Standards Board (ASB) does not establish new standards or interpret*
3 *existing standards. Advisory Opinions are issued to illustrate the applicability of appraisal standards in specific*
4 *situations and to offer advice from the ASB for the resolution of appraisal issues and problems.*

5 **SUBJECT: Assignments Involving More than One Appraiser**

6 **APPLICATION: Real Property, Personal Property, Intangible Property**

7 **THE ISSUE:**

8 What are the specific USPAP obligations when an appraisal, appraisal review or appraisal consulting
9 assignment involves more than one appraiser?

10 **BACKGROUND:**

11 Many appraisal assignments involve participation by more than one appraiser. Typical scenarios include, but
12 are not limited to:

- 13 • Two appraisers working together as equals on an assignment.
- 14 • A staff appraiser whose work is reviewed and/or directed by a more senior appraiser.
- 15 • A person who is being trained as an appraiser (“trainee”) and requires supervision and direction by an
16 appraiser already fully qualified to complete the assignment.
- 17 • An independent appraiser/contractor performing work for an appraisal firm.
- 18 • Two or more appraisers from different appraisal disciplines working on an assignment.

19 When assignments involve more than one appraiser there are often questions about the proper way to deal with
20 USPAP requirements relating to record keeping, signatures and certifications.

21 It is important to realize that USPAP does not define an “appraiser” in terms of state licensing or certification
22 requirements. USPAP defines an appraiser as one who is expected to perform valuation services competently
23 and in a manner that is independent, impartial, and objective. Expectation is the crucial element in determining
24 when one is acting as an appraiser. As a result, one could be a trainee by state licensing requirements and also
25 identified as an appraiser by USPAP definition. Reference to applicable state law should be made to clarify the
26 specific definition of appraiser and trainee in a jurisdiction.

27 **ADVICE FROM THE ASB ON THE ISSUE**

28 **Relevant USPAP References**

- 29 • SCOPE OF WORK RULE, which requires that the appraiser disclose the scope of work performed.
- 30 • RECORD KEEPING RULE.
- 31 • Standards Rules 2-2(a)(vii), 2-2(b)(vii), 2-2(c)(vii), 3-2(c), 5-2(f), 6-8(j), 8-2(a)(vii), 8-2(vii) (b), 8-
32 2(c)(vii), 10-2(a)(viii) and 10-2(b)(viii), which specify the reporting requirements when any portion of
33 the work involves significant assistance.

- 34 • Standards Rules 2-3, 3-6, 5-3, 6-9, 8-3 and 10-3, which identify the requirements for an appraiser who
35 is signing the certification and also for instances when appraisers provide significant assistance but do
36 not sign the certification.

37 **Record Keeping Requirements**

38 The RECORD KEEPING RULE requires:

39 *An appraiser must prepare a workfile for each appraisal, appraisal review, or appraisal consulting*
40 *assignment. A workfile must be in existence prior to the issuance of any report.*
41

42 The Rule also mandates that workfiles be retained for a specified time, and states,

43 *An appraiser must have custody of the workfile, or make appropriate workfile retention, access and*
44 *retrieval arrangements with the party having custody of the workfile.*

45 *An appraiser having custody of a workfiles must allow other appraisers with workfile obligations related*
46 *to an assignment appropriate access and retrieval for the purpose of:*

- 47 • *submission to state appraiser regulatory agencies;*
48 • *compliance with due process of law;*
49 • *submission to a duly authorized professional peer review committee; or*
50 • *compliance with retrieval arrangements.*

51 When an assignment is performed by more than one appraiser, each appraiser is subject to the same obligations
52 regarding the workfile for the assignment, whether or not the appraiser signs the certification. These obligations
53 may be met by creating a copy of the workfile for every appraiser involved in the assignment. Alternatively,
54 the appraisers might agree in writing to an access arrangement whereby the workfile is stored in a single
55 location but access is provided to all appraisers involved. In whatever manner this USPAP requirement is met,
56 all appraisers involved with the assignment must meet it.

57 **Certifications/Signatures**

58 A signed certification is required for all appraisal, appraisal review and appraisal consulting reports. An
59 appraiser who signs any part of a report, including a letter of transmittal, must also sign the certification.

60 A signed certification provides important disclosures about aspects of the assignment. It provides evidence that
61 the appraiser is aware of the ethical obligations of acting as an appraiser. In single-discipline appraisals, the
62 certification also attests that the analyses, opinions, and conclusions expressed are those of the signatory. The
63 certification is also where significant appraisal assistance from others not signing the certification must be
64 acknowledged. Any appraiser who provides significant appraisal, appraisal review, or appraisal consulting
65 assistance to the assignment must sign the certification or be identified in the certification. When more than one
66 appraiser is involved in an assignment, USPAP allows for certification in a variety of ways, including:

- 67 • all appraisers could sign a certification accepting responsibility for the entirety of the analyses and the
68 report if they are all competent to do so; or
69 • one appraiser could sign a certification and provide the name of each individual who provided
70 significant appraisal, appraisal review, or appraisal consulting assistance. In such a case, the exact
71 nature of the assistance must be reported, but this need not be in the certification; or

- 72 • for assignments involving multiple disciplines (e.g., real property appraisal and personal property
73 appraisal), an appraiser could sign a certification accepting responsibility only for the elements of the
74 certification, assignment results and report contents applicable to the appraiser’s discipline.

75 **Illustrations**

76 *Workfile Obligations When Trainee Signs the Report*

- 77 1. Jennifer is currently being trained as an appraiser (a trainee) working toward her state license as a real
78 property appraiser. Her work includes completing and co-signing appraisal reports with her
79 supervising appraiser. Must she keep a copy of the workfile for every assignment she works on?

80 If Jennifer acted as an appraiser in the assignment, USPAP provides two options: 1) she can
81 maintain custody of the workfile, either the original or a copy; or 2) she can make appropriate
82 access arrangements for the retention period, for example, with her employer or supervising
83 appraiser.

84 Some common scenarios in such an assignment may include the trainee appraiser and the
85 supervising appraiser each keeping a copy of the workfile. Or, the supervising appraiser may
86 retain custody of the workfile and provide for access by the trainee appraiser. Both of these
87 arrangements meet the record keeping requirements.

88 *Certification Requirements When Trainee Does Not Sign the Report*

- 89 2. Using the same scenario from Illustration 1 except only the senior appraiser signs the report and **not**
90 the trainee appraiser, what certification requirements must each appraiser meet to comply with
91 USPAP?

92 USPAP states that when a signing appraiser relies on work done by others who do not sign the
93 certification, the signing appraiser is responsible for the decision to rely on the trainee appraiser’s
94 work.

95 The name of the trainee appraiser who provided significant assistance, but does not sign the
96 certification, must be stated in the certification. It is not required that the description of the
97 assistance appear in the certification, but the extent of the assistance must be set forth in the report
98 as required in STANDARDS 2, 3, 5, 6, 8 and 10. The degree of this description is identified by the
99 applicable reporting option for the assignment. For example, in a Summary Appraisal Report the
100 extent of the significant assistance must be “summarized.”

101 *Possession of Workfiles*

- 102 3. An appraiser is an employee of an appraisal firm. The firm has announced that the office is moving to
103 another city. All appraisers not moving to the new location have been asked to turn over their
104 workfiles to the company. The appraiser believes that he is required to keep the workfiles. Who is
105 correct?

106 The RECORD KEEPING RULE does not mandate that an appraiser have possession of
107 assignment workfiles. Employment contracts and other employment arrangements often require
108 appraisers to leave their workfiles with an employer should the appraiser leave that firm, or in
109 other situations. However, if an appraiser must relinquish actual possession of the workfiles, the
110 appraiser must establish appropriate access arrangements for the length of the retention period. In
111 the circumstances described, another solution may be for the appraiser to obtain permission from
112 the employer to make copies of his or her workfiles.

113 4. Jonathan is a trainee appraiser who has been working with the same supervising appraiser for some
 114 time. Recently, his supervising appraiser told him that since he was only a trainee, he had no right to
 115 access workfiles on appraisals where he had provided significant professional assistance. Is the
 116 supervising appraiser correct? Do trainees have any rights regarding access to workfiles?

117 The supervising appraiser is not correct. USPAP places workfile retention requirements on the
 118 **appraiser**. Jonathan, since he is acting as an appraiser, is an appraiser as defined in USPAP. In
 119 assignments where more than one appraiser is involved (e.g. a trainee appraiser and a supervising
 120 appraiser) each appraiser shares responsibility for complying with the RECORD KEEPING
 121 RULE.

122 Supervising appraisers should be aware that all appraisers, including trainee appraisers, must
 123 maintain access to workfiles for a minimum of five years. A supervising appraiser must not
 124 impede a trainee appraiser's ability to access a workfile under the following conditions:

- 125 • submission to state appraiser regulatory agencies;
- 126 • compliance with due process of law;
- 127 • submission to a duly authorized professional peer review committee; or
- 128 • compliance with retrieval arrangements..

129 Denying access to a workfile that the trainee worked on is a violation of the ETHICS RULE.

130 *An individual appraiser employed by a group or organization that conducts itself in a manner*
 131 *that does not conform to these Standards should take steps that are appropriate under the*
 132 *circumstances to ensure compliance with the Standards.*

133 *Acknowledging Significant Appraisal Assistance*

134 5. Matthew, an appraiser, is working with a more senior appraiser on a complex appraisal assignment.
 135 His only task has been to develop the income approach based on information provided by the senior
 136 appraiser. What is the appropriate way to acknowledge Matthew's role in the assignment?

137 Since Matthew's work is limited to part of the assignment, signing a certification accepting
 138 responsibility for the entire assignment would not be appropriate. USPAP requires that Matthew
 139 be named in the certification, and the nature of his significant assistance be reported.

140 6. Margaret is performing a specific portion of a complex appraisal assignment, but is not competent to
 141 complete the entire assignment. As part of her training, she read the report and discussed it with the
 142 senior appraiser. Having now expanded her knowledge of the assignment, she wants to sign the
 143 certification along with the senior appraiser on the project. Is this appropriate?

144 No. By signing the certification, she would be accepting full responsibility for all elements of the
 145 certification, for the assignment results, and for the contents of the appraisal report. Although she
 146 was competent to perform her assigned task, reading the report and discussing it with the senior
 147 appraiser does not confer competence. Therefore, she cannot accept full responsibility for the
 148 assignment results or sign the certification.

ADVISORY OPINION 32

1 **ADVISORY OPINION 32 (AO-32)**

2 *This communication by the Appraisal Standards Board (ASB) does not establish new standards or interpret*
3 *existing standards. Advisory Opinions are issued to illustrate the applicability of appraisal standards in specific*
4 *situations and to offer advice from the ASB for the resolution of appraisal issues and problems.*

5 **SUBJECT: Ad Valorem Property Tax Appraisal and Mass Appraisal Assignments**

6 **APPLICATION: Real Property, Personal Property**

7 **THE ISSUE:**

8 *Ad valorem* is Latin for “according to value.” In ad valorem taxation assignments, the appraisal or mass
9 appraisal is used to establish a value basis for a political subdivision’s tax burden. This guidance is provided to
10 address the application of USPAP to appraisal and mass appraisal assignments for ad valorem taxation.

11 As used in this Advisory Opinion, “appraisal assignments” are those covered by STANDARDS 1 and 2 or
12 STANDARDS 7 and 8. “Mass appraisal assignments” are those covered by STANDARD 6.

13 **ADVICE FROM THE ASB ON THE ISSUE**

14 **Application of Standards**

15 Ad valorem taxation assignments include both appraisal assignments and mass appraisal assignments.

- 16 • STANDARDS 1 & 2 address the requirements for development of an appraisal and reporting
17 of appraisal results for a particular real property interest as of a given date.
- 18 • STANDARD 6 addresses the requirements for development of a mass appraisal and reporting
19 of mass appraisal results for real property and personal property. Mass appraisal is the
20 valuation of a universe of properties (many properties) as of a given date using standard
21 methodology, employing common data, and allowing for statistical testing. Mass appraisal
22 provides for a systematic approach and uniform application of appraisal methods and
23 techniques to obtain estimates of values that allow for statistical review and analysis of
24 results.
- 25 • STANDARDS 7 & 8 address the requirements for development of an appraisal and reporting
26 of appraisal results for a particular personal property interest as of a given date.

27 The keys to distinguishing a mass appraisal are: 1) the subject of the appraisal is a “universe” of properties,
28 meaning more than one property; and 2) the assignment involves standard methodology employing common
29 data that allows for statistical testing. These models may be based on the cost approach, the income approach
30 and/or the sales comparison approach to value.

31 **Identification of Intended Users**

32 In ad valorem taxation assignments, the client is typically the government or taxing authority that engages the
33 appraiser. As defined in USPAP, the intended users include the client. Through communication with the client,
34 the appraiser may identify other intended users. A party receiving a copy of a report in order to satisfy
35 disclosure requirements does not become an intended user of the appraisal or mass appraisal unless the
36 appraiser identifies such party as an intended user as part of the assignment.

37 Scope of Work

38 The determination of an appropriate scope of work in all appraisal and mass appraisal assignments, including ad
39 valorem taxation assignments, is based on problem identification. The assignment elements necessary for
40 problem identification are identified in Standards Rule 1-2 (real property appraisal), Standards Rule 6-2 (real
41 property and personal property mass appraisal) and Standards Rule 7-2 (personal property appraisal). This
42 information provides the appraiser with the basis for determining the scope of work necessary to develop
43 credible assignment results.

44 In ad valorem taxation assignments, applicable laws and regulations of an assessing jurisdiction may define the
45 assignment elements needed for problem identification. For example, the type and definition of value is usually
46 established by statute, as is the effective date of the appraiser's opinions and conclusions (tax year, levy year,
47 valuation date, etc). Whatever the source of the assignment elements needed for problem identification, the
48 appraiser must identify the problem to be solved, and determine and perform the scope of work necessary to
49 develop credible assignment results.

50 In the interests of equity, the scope of work in mass appraisal assignments for ad valorem taxation can include
51 consideration of appraisal level (the overall proximity between appraised values and actual prices) and the
52 uniformity of property values (equity within groups of like properties). Standard Rule 6-1 (a) states:

53 *In developing a mass appraisal, an appraiser must: (a) be aware of, understand, and correctly employ*
54 *those recognized methods and techniques necessary to produce a credible mass appraisal;*

55 The appraiser is responsible for recognizing when the concepts of appraisal level and appraisal uniformity are
56 necessary for credible assignment results in a mass appraisal assignment for ad valorem taxation.

57 Reporting

58 Standards Rules 6-8 and 6-9 address the requirements for reporting mass appraisal results for real property and
59 personal property. The Mass Appraisal Report must clearly communicate the elements, results, opinions, and
60 value conclusions of the mass appraisal. In mass appraisals for ad valorem taxation, local statutes may
61 prescribe additional reporting requirements and procedures for the delivery of the assignment results.

62 In mass appraisal, the value opinion for each property is developed using the standard methods applied in the
63 mass appraisal model for a universe of properties. There may be many mass appraisal models used to value an
64 entire universe of properties. An individual property record or worksheet may describe the valuation of the
65 specific property after the application of the mass appraisal model. A written report of the mass appraisal as
66 described in Standards Rule 6-8 is not provided for each individual property. To understand the individual
67 property result developed in a mass appraisal requires the examination of all the information and analysis
68 required by Standards Rule 6-8.

69 STANDARDS 2 & 8 address the requirements for reporting of appraisal results for real property and personal
70 property (respectively). The written report must be presented in a Self-Contained Appraisal Report, Summary
71 Appraisal Report, or Restricted Use Appraisal Report.

72 An appraiser may be asked to communicate the assignment results for a single property that was appraised as
73 part of a mass appraisal assignment. USPAP does not address this specific circumstance. The reporting
74 requirements of STANDARD 2 apply to appraisal assignments developed under STANDARD 1 and do not
75 apply to mass appraisal assignments prepared under STANDARD 6. However, the second sentence of the
76 PREAMBLE states: *It is essential that appraisers develop and communicate their analyses, opinions, and*
77 *conclusions to intended users of their services in a manner that is meaningful and not misleading.* Additionally,
78 the ETHICS RULE states: *An appraiser must not communicate assignment results with the intent to mislead or*
79 *defraud.* The ETHICS RULE also states: *An appraiser must not use or communicate a report that is known by*

80 *the appraiser to be misleading or fraudulent.* Therefore, if an appraiser communicates mass appraisal results for
81 a single property, the communication must be meaningful and must not be misleading.

82 In assignments for ad valorem taxation, public policy may direct property owner notification of the property
83 values rendered as a result of an appraisal or mass appraisal. Notifications are commonly required within the
84 jurisdiction to meet due process requirements. These property owner notifications are not “reports” as defined
85 in USPAP. Further, a party receiving a notification in order to satisfy disclosure requirements does not become
86 an intended user unless the appraiser identifies such party as an intended user as part of the assignment.

87 **Workfile Requirements**

88 The RECORD KEEPING RULE requirement to prepare a workfile applies to appraisals and mass appraisals
89 performed for ad valorem taxation assignments. An appraiser’s assignment workfile preserves evidence of the
90 appraiser’s compliance with USPAP and other information as may be required to support the appraiser’s
91 opinions and conclusions.

92 For a mass appraisal assignment, compliance with the RECORD KEEPING RULE requires a workfile for the
93 mass appraisal assignment, not a workfile for each property in the mass appraisal. The workfile for a mass
94 appraisal contains the information to support the valuation of all properties in the mass appraisal. This
95 supporting material may be documented in any form of media, including electronic files, and includes such
96 items as property records, market data, sales ratios and other statistical studies, appraisal manuals and
97 documentation, market studies, model building documentation, regulations, statutes, property photos, sketches,
98 aerial imagery, maps, automated mapping and geographic information systems, worksheets, spreadsheets, and
99 analysis reports. USPAP does not dictate the form or format of workfile documentation. There is no
100 requirement that the contents of the workfile be held in a single location.

101 The retention of the workfile in support of an assignment for ad valorem taxation is governed by USPAP and
102 may also be subject to retention schedules in the jurisdictions. The record retention time frames referenced in
103 the RECORD KEEPING RULE are minimums. Retention beyond the USPAP requirements is permitted.
104 Unless compelled by law or regulation, USPAP does not permit appraisers to destroy records prior to five years
105 after preparation **for any reason.** An appraiser citing a jurisdictional exception must comply with the
106 requirements of the JURISDICTIONAL EXCEPTION RULE.

107 **JURISDICTIONAL EXCEPTION RULE**

108 The JURISDICTIONAL EXCEPTION RULE exempts appraisers from the part or parts of USPAP that are
109 precluded by the law or regulation of a particular jurisdiction. If compliance with a part of USPAP is precluded
110 by any applicable federal, state, or local law or regulation, only that part shall be of no force and effect in that
111 assignment. Appraisers using the JURISDICTIONAL EXCEPTION RULE must properly disclose the legal
112 authority justifying the exemption of part or parts of USPAP that are precluded by law.

113 Use of the JURISDICTIONAL EXCEPTION RULE is triggered by a contradiction between the requirements of
114 USPAP and the law or regulations of a jurisdiction, not by client or appraiser discretion.

115 USPAP does not establish who or which assignments must comply. Therefore, the JURISDICTIONAL
116 EXCEPTION RULE cannot be applied to the decision to comply with USPAP.

117 An individual’s identification as an appraiser is the basis for determining who should comply with USPAP.
118 This is because an individual’s public identification as an appraiser establishes an expectation that valuation
119 services will be performed in compliance with USPAP. An individual must comply with USPAP when
120 required by law, regulation, or agreement. Even if the governing authority’s policy does not require USPAP
121 compliance, other applicable law or regulation might require compliance.

122 **Illustrations**

123 1. An appraiser is in the process of developing appraisals for the next year's tax roll. The residential
124 properties, condominiums, and general commercial and major commercial properties will be valued
125 with a mass appraisal model. Which development standards apply?

126 Because the subject of the appraisal is a universe of properties, and because they are being
127 appraised with a mass appraisal model, STANDARD 6 applies.

128 2. An appraiser has completed a mass appraisal for ad valorem taxation using a mass appraisal model.
129 There is a special use property for which it has been determined that the mass appraisal model is not
130 appropriate. This property will be appraised as an individual property. Which development standard
131 applies to the appraisal of the special use property?

132 Even though the special use property is being appraised for ad valorem taxation, STANDARD 1
133 would apply because the subject is an individual property, not a universe of properties.

134 3. An assessment appeal is in process, and an appraisal of an individual property is being conducted as
135 part of that appeal. Which development standards apply?

136 STANDARD 1 or STANDARD 7 would apply because an individual property is being appraised
137 rather than a universe of properties.

138 4. An appraiser is conducting a mass appraisal for ad valorem taxation. A property record card is
139 produced for each property. Is each property record card considered a report under STANDARD 6?

140 No. The property record card is not the mass appraisal report; it is only a portion of the
141 information and analysis supporting the mass appraisal.

USPAP FREQUENTLY ASKED QUESTIONS (FAQ)

2012-2013 EDITION

USPAP FREQUENTLY ASKED QUESTIONS

FREQUENTLY ASKED QUESTIONS

APPRAISAL STANDARDS BOARD



THE APPRAISAL FOUNDATION

*Authorized by Congress as the Source of Appraisal
Standards and Appraiser Qualifications*

USPAP FREQUENTLY ASKED QUESTIONS

2012-2013 EDITION

APPRAISAL STANDARDS BOARD



THE APPRAISAL FOUNDATION

*Authorized by Congress as the Source of Appraisal
Standards and Appraiser Qualifications*

Published in the United States of America.

All rights reserved.

No parts of this publication may be reproduced, stored in a retrieval system, or transmitted in any form or by any means, electronic, mechanical, photocopy, recording or otherwise, without the prior written consent of the publisher.

EFFECTIVE:

**January 1, 2012 through
December 31, 2013**

APPRAISAL STANDARDS BOARD



THE APPRAISAL FOUNDATION

*Authorized by Congress as the Source of Appraisal
Standards and Appraiser Qualifications*

FOREWORD

The Appraisal Standards Board (ASB) of The Appraisal Foundation develops, interprets, and amends the *Uniform Standards of Professional Appraisal Practice* (USPAP) on behalf of appraisers and users of appraisal services. **The 2012-2013 edition of USPAP (2012-2013 USPAP) is effective January 1, 2012 through December 31, 2013.** It is important that individuals understand and adhere to changes in each edition of USPAP. State and federal authorities enforce the content of the current or applicable edition of USPAP.

USPAP Frequently Asked Questions (USPAP FAQ) is a form of guidance issued by the ASB to respond to questions raised by appraisers, enforcement officials, users of appraisal services and the public to illustrate the applicability of USPAP in specific situations and to offer advice from the ASB for the resolution of appraisal issues and problems. The advice presented may not represent the only possible solution to the issues discussed and the advice provided may not be applied equally to seemingly similar situations. USPAP FAQ does not establish new standards or interpret existing standards. USPAP FAQ is not part of USPAP and is approved by the ASB without public exposure and comment.

The ASB periodically issues the USPAP Q&A, which is posted on The Appraisal Foundation website (www.appraisalfoundation.org). The USPAP Q&A is issued to inform appraisers, enforcement officials, and users of appraisal services of the ASB responses to questions received by the Board.

The ASB compiles the USPAP Q&A into the USPAP FAQ for publication with each edition of USPAP. For this 2012-2013 edition of USPAP, Q&As through January 2010 have been included. In addition to incorporating the most recent questions and responses issued by the ASB, the USPAP FAQ is reviewed and updated to ensure that it represents the most recent guidance from the ASB.

Contacting the Appraisal Standards Board

The ASB invites questions about USPAP, commentary on USPAP, and proposed changes to USPAP from all interested parties, including appraisers, state enforcement agencies, users of appraisal services, and the public.

If you have any comments, questions, or suggestions regarding USPAP, please contact the ASB.

Appraisal Standards Board
The Appraisal Foundation
1155 15th Street, NW, Suite 1111
Washington, DC 20005
Phone: 202-347-7722
Fax: 202-347-7727
E-Mail: info@appraisalfoundation.org
www.appraisalfoundation.org

TABLE OF CONTENTS

TABLE OF CONTENTS

USPAP FREQUENTLY ASKED QUESTIONS

Throughout *USPAP Frequently Asked Questions*, titles of questions and responses that are new for this 2012-2013 edition are identified with the word “New” at the end of the title.

USPAP Composition Structure and Compliance.....	F-1
1. Advisory Opinions Not Part of USPAP.....	F-1
2. Valuation Service Defined.....	F-1
3. Retiring a Portion of USPAP.....	F-1
4. The Primary Purpose of USPAP.....	F-2
5. Complying With USPAP by Choice.....	F-2
6. Compliance With USPAP: Personal Property, Business Valuation and Intangible Asset Appraisers ...	F-3
7. USPAP Applicability in Valuation for Financial Reporting.....	F-3
8. Assignment Involving Analysis of Leases.....	F-4
9. USPAP Compliance as an Instructor.....	F-4
10. Personal Property Appraisal Requirements.....	F-5
11. USPAP Compliance With Other Valuation Standards.....	F-5
ETHICS RULE - CONDUCT.....	F-6
12. Don't Accept Unless you Can Appraise for \$XXX,000.....	F-6
13. Appraiser Coercion.....	F-6
14. Plagiarism.....	F-7
15. Use of Qualitative Terms.....	F-7
16. Conflicts of Interest.....	F-7
17. Disclosing Prior Appraisal of a Property (NEW).....	F-8
18. Disclosure Requirements When an Appraiser Has NOT Performed Services Regarding a Property in the Prior Three Years (NEW).....	F-8
19. Disclosure of any prior services regarding the subject property, when an appraiser has appraised the property multiple times (NEW).....	F-9
20. Disclosing Additional Information Regarding a Prior Appraisal (NEW).....	F-9
21. Client Requirement to Maintain Confidentiality (NEW).....	F-9
22. Disclosure of Any Prior Services Regarding the Subject Property Before Accepting an Assignment, When the Client Had Previously Required an Appraiser to Sign a Confidentiality Agreement (NEW).....	F-10
23. Disclosure of Any Prior Services Regarding the Subject Property Before Accepting an Assignment, When the Appraiser Only Works for One Client (NEW).....	F-10
24. Disclosure of Any Prior Services Regarding the Subject Property, When an Appraiser Has Performed Services Other than Appraisal Practice (NEW).....	F-11
25. Disclosing Prior Services More Than Three Years Ago (NEW).....	F-11
26. Disclosing Prior Services Provided By My Company (NEW).....	F-11
27. Disclosing Prospective Interest In a Property (NEW).....	F-11

TABLE OF CONTENTS

28.	Disclosing Prior Services On Pre-printed Form Reports (NEW)	F-12
29.	Is There a Specified Format for Disclosing Prior Services at the Time of Assignment? (NEW)).....	F-12
30.	Value Opinions That Equal Contract Prices	F-12
31.	Property Flipping.....	F-13
32.	Are Condition And Marketability Reports Covered by USPAP.....	F-14
33.	Supported And Unsupported Conclusions.....	F-15
34.	Unacceptable Assignment Conditions – Nondisclosure of Facts	F-15
ETHICS RULE - MANAGEMENT.....		F-16
35.	Fees Paid for Procurement of an Assignment.....	F-16
36.	Coupons for Price Discounts	F-16
37.	Payment of Fees to Be Included on Approved Appraisers List.....	F-16
38.	Conducting Drawings to Procure Appraisal Assignments.....	F-17
39.	Reducing Appraisal Fees When Transactions Fail to Close	F-17
40.	Appraisal Fees as Percentages of Value Conclusions.....	F-18
41.	Appraisal Fee Is Contingent on the Appraised Value.....	F-18
42.	Appraiser’s Fees Based on Pending Sale Price.....	F-19
43.	Discounted Appraisal Fees	F-19
44.	Disclosure of Referral Fee Amounts	F-19
45.	Reciprocal Business Arrangements	F-19
46.	Does USPAP Apply if There Is No Assignment Fee?.....	F-20
47.	Can Appraisers Perform Comp Check Assignments for Free?.....	F-20
48.	Is Disclosure of a Free Comp Check Assignment Required?.....	F-21
49.	Appraisal Fee Paid at Close of Financing Transaction.....	F-21
50.	Collecting Fee on Behalf of an AMC (NEW)	F-22
ETHICS RULE – CONFIDENTIALITY		F-23
51.	Reporting of Adverse Conditions	F-23
52.	Due Process of Law (NEW)	F-23
53.	Disclosing Results of Appraisal Assignments	F-23
54.	Appraisal Report Received by Others	F-24
55.	Disclosure of a Prior Assignment	F-24
56.	Disclosure of the Client in a Prior Assignment	F-25
57.	Can an Appraiser Disclose the Identity of Past Clients in an Appraisal Report?	F-25
58.	Sample Appraisals And the Ethics Rule.....	F-26
59.	Providing Sample Appraisal Reports.....	F-26
60.	Confidentiality And Sample Appraisal Reports	F-27
61.	Delivering a Report by Email to a Client	F-28
62.	Confidentiality And Intended Users	F-28
63.	Confidentiality and Review Appraisers.....	F-28
64.	Disclosure of Assignment Results to State Appraiser Regulatory Agency	F-29
65.	Due Process Under Confidentiality	F-29

TABLE OF CONTENTS

66.	Communicating Confidential Information to a Sworn Peace Officer.....	F-30
67.	Confidentiality And Peer Review Committees.....	F-30
68.	Confidentiality And Privacy Regulations.....	F-31
69.	When does Appraiser-Client Confidentiality End?.....	F-31
70.	Copyrighting an Appraisal Report.....	F-32
71.	Selling an Appraisal Firm And Ethical Obligations.....	F-32
72.	Purchasing an Appraisal Firm And Ethical Obligations.....	F-33
	RECORD KEEPING RULE.....	F-34
73.	Contents of a Workfile.....	F-34
74.	Time Period to Retain Workfiles.....	F-34
75.	Disposal of Workfiles (NEW).....	F-35
76.	Photocopies of Appraisal Reports in Workfiles.....	F-35
77.	Workfiles for Appraisal Review Assignments.....	F-35
78.	Purging Workfiles at a Client’s Request.....	F-36
79.	Workfile Retention With More Than One Appraiser.....	F-36
80.	Responsibility for Workfile Retention.....	F-37
81.	Trainee Access to Workfiles.....	F-38
82.	Appropriate Workfile Retention And Access Arrangements.....	F-38
83.	May Access to a Workfile Be Denied?.....	F-39
84.	Access and Retrieval of Workfiles (NEW).....	F-39
85.	Signed Certification in True Copies.....	F-39
86.	Creating a Workfile After Report Delivery.....	F-40
87.	Is a Transcript Required for Oral Report And Testimony?.....	F-40
88.	Is a Transcript Required if a Written Appraisal Report Was Prepared?.....	F-40
89.	Record Keeping Requirements for Oral Reports And Testimony.....	F-40
90.	Is a Separate Certification Required if a Written Appraisal Report Was Prepared?.....	F-41
91.	Is a Transcript of the Entire Proceeding Required?.....	F-41
92.	Electronic Workfile Storage.....	F-41
93.	Paper Copies of Electronically Transmitted Reports.....	F-42
94.	Adequacy of Workfile Documentation.....	F-42
95.	Jurisdictional Exception And Workfile Retention.....	F-42
96.	Minimum Workfile Retention.....	F-43
	COMPETENCY RULE.....	F-44
97.	Acquiring Knowledge And Experience to Comply With the Competency Rule.....	F-44
98.	Assignment Conditions, Scope of Work Acceptability, and Geographic Competency (NEW).....	F-44
99.	Continuing Education Courses.....	F-45
100.	Competency Statement in the Report.....	F-46
101.	Errors and Omissions Insurance.....	F-46
	JURISDICTIONAL EXCEPTION RULE.....	F-47
102.	Application of the Jurisdictional Exception Rule.....	F-47
103.	USPAP Compliance and Jurisdictional Exception.....	F-47

TABLE OF CONTENTS

104.	When Compliance with USPAP Is Precluded by Law Or Regulation.....	F-48
105.	Probate Court Statute Basing the Appraisal Fee on the Appraised Value	F-48
106.	Appropriate Sources for Jurisdictional Exception	F-48
107.	Valuation Methods And Jurisdictional Exception Rule.....	F-49
108.	Client Requirement to Disregard Market Value Changes Prior to Effective Date (NEW).....	F-50
109.	Client Requirement to Disregard the Influence on Market Value of Public Improvements (NEW)	F-50
110.	Is a “Waiver Valuation” a Jurisdictional Exception? (NEW).....	F-51
111.	Client Requirement to Assume No Contamination Exists (NEW)	F-51
112.	Jurisdictional Exception And Confidentiality.....	F-52
APPRAISAL DEVELOPMENT – CLIENT ISSUES		F-53
113.	Identification of the Client.....	F-53
114.	Payment by a Party Other Than the Client	F-53
115.	Difference Between Clients And Intended Users	F-53
116.	Appraisal Management Company as Authorized Agent for a Client	F-54
117.	Can an Appraisal Management Company be the Client? (NEW).....	F-54
118.	Client Cannot Be Identified.....	F-54
119.	Subsequent User Requests a Reliance Letter.....	F-55
120.	Readdress or Transfer.....	F-55
121.	Readdressing With Lender Release	F-56
122.	Identification of Intended Users	F-56
123.	Addressees, Clients, And Intended Users.....	F-57
124.	Appraising Without Knowing the Intended Use Or Intended User	F-58
125.	Are Borrowers Intended Users?.....	F-58
126.	Identifying Intended Users by Type	F-58
127.	Engaged Directly by the Homeowner.....	F-59
128.	Client Approval for Future Assignments.....	F-59
129.	Request to Modify a Completed Appraisal Report (NEW)	F-59
APPRAISAL DEVELOPMENT – APPRAISAL DATES.....		F-61
130.	Effective Date of the Appraisal	F-61
131.	Date of Appraisal.....	F-61
132.	Date of Value.....	F-61
133.	Citation of Effective Date.....	F-61
134.	Changing the Effective Date.....	F-62
135.	Does Changing the Sale Price Result in a New Assignment?	F-62
136.	Current Value Opinions for Proposed ImprovementS.....	F-63
137.	Proposed Improvements – Current And Prospective Value Opinions.....	F-63
138.	Effective Date and Date of the Report (NEW).....	F-63
139.	Competency As Of Effective Date of the Appraisal.....	F-64
140.	Current And Retrospective Value Opinions Within One Report.....	F-64
141.	Post-Value Date Information in Retrospective Appraisals	F-65

TABLE OF CONTENTS

142.	Appraisal Based on Current And Prospective Dates of Value.....	F-65
143.	USPAP Compliance in Retrospective Appraisals.....	F-66
144.	Retrospective Appraisal Assignments	F-66
APPRAISAL DEVELOPMENT – SCOPE OF WORK ISSUES		F-68
145.	What Is Scope of Work?.....	F-68
146.	Applicability of Scope of Work Rule	F-68
147.	Responsibility for the Scope of Work Decision	F-68
148.	Client Specifies Scope of Work.....	F-68
149.	Client Request to Limit Scope of Work to New Client Name (NEW)	F-69
150.	The Impact of Different Clients on Assignment Results with Otherwise Identical Assignment Elements and Scope of Work	F-69
151.	Obligation to Analyze Withdrawn Or Expired Listings	F-71
152.	How Credible Assignment Results Are Measured	F-71
153.	Errors of Commission and Omission.....	F-71
154.	Making a Series of Errors.....	F-72
155.	Changing the Scope of Work after the Report has been Submitted.....	F-72
156.	Judging The Actions of AN Appraiser’s Peers.....	F-72
157.	Type And Definition of Value, And Citation of Source	F-73
158.	Market Rent Opinion	F-73
159.	Using the Definition of Value Provided	F-74
160.	Sales Or Financing Concessions.....	F-74
161.	Intentionally Deflating Opinions of Value	F-75
162.	Measuring Single Family Residences Using the ANSI Standard	F-75
163.	Exposure Time And Marketing Time.....	F-75
164.	Checking Stable vs. Declining Property Values	F-76
165.	Range of Value	F-76
166.	More Than One Intended Use.....	F-76
167.	Value in Use Request From Federally Regulated Lender.....	F-77
168.	Drive-by and Desktop Appraisals.....	F-77
169.	Inspection of Subject Property.....	F-77
170.	Does Inspection of Subject Property Mean a Physical Inspection?	F-78
171.	Is it Permissible to Use MLS Photos for Comparable Sales?	F-78
172.	Is it Permissible to Use MLS Photos for Active Listings?	F-79
173.	Cost Approach Not Necessary for Appraisal of Vacant Land	F-79
174.	Cost Approach And Fannie Mae Form 1004/Freddie Mac Form 70	F-80
175.	Appraising Improved Land.....	F-80
176.	Improvement Only Appraisal	F-80
177.	Appraising Only the Underlying Land of an Improved Property	F-81
178.	Appraising Physical Segments (5-Acre Portion)	F-81
179.	Income And Expense Analyses	F-82
180.	Proposed Improvements – Plans And Specifications Required.....	F-82

TABLE OF CONTENTS

181.	Is an AVM An Appraisal?	F-82
182.	Appraiser’s USPAP Obligations When Using an AVM.....	F-83
183.	Uniform Act And Scope of Work.....	F-83
184.	Appraising Large Groups of Similar Or Like Items	F-84
185.	Blockage Discount And Standard 6.....	F-84
186.	Calculating Blockage Discount	F-84
187.	Business Valuation Using Asset-Based (Cost) Approach	F-85
188.	Allocation of Value Opinions.....	F-85
189.	Leased Fee Interest When Intangible Assets Exist	F-87
190.	Purchase Contract Is Not Provided to the Appraiser	F-88
191.	Availability of Current Agreement of Sale.....	F-89
192.	Reconciliation of the Approaches to Value	F-89
193.	Adjustments in Sales Comparison Approach	F-89
194.	Updating a Prior Assignment with a Different Scope of Work	F-90
195.	Appraisal Update With No Change In Value	F-90
196.	Update of an Appraisal Completed by Another Appraiser	F-90
197.	Does A New Assignment Require Starting Over?.....	F-91
198.	Recertification of Value.....	F-91
199.	Recertification of Value And Appraisal Update.....	F-91
200.	Appraisers Providing Comps.....	F-92
201.	Can Appraisers Perform Comp Check Assignments?	F-92
202.	Sudden Market Changes Related to Catastrophic Events.....	F-93
203.	Citing the Source of the Value Definition And Fannie Mae Form 1004/Freddie Mac Form 70	F-93
APPRAISAL DEVELOPMENT – EXTRAORDINARY ASSUMPTIONS AND HYPOTHETICAL CONDITIONS		F-95
204.	Extraordinary Assumptions Compared to Hypothetical Conditions.....	F-95
205.	Hypothetical Conditions Described.....	F-96
206.	When a Hypothetical Condition May Be Used.....	F-97
207.	Before Acquisition Value And Standards Rule 1-4(f).....	F-97
208.	Reporting Use of Extraordinary Assumptions And Hypothetical Conditions	F-98
209.	Must a Hypothetical Condition or Extraordinary Assumption be Labeled?.....	F-99
210.	Value as if Completed	F-99
211.	Appraising a Property Not In As-Is Condition	F-100
212.	Analyzing the Lease When Appraising Fee Simple Interest	F-100
213.	Definition of Extraordinary Assumption	F-101
APPRAISAL DEVELOPMENT – SUBJECT PROPERTY SALES HISTORY		F-102
214.	Multiple Sales Or Transfers of the Subject Property	F-102
215.	Offers to Purchase Subject Property	F-103
216.	Current Sales Contract Is Not Provided.....	F-103
217.	Pending Sales as Comparables	F-104
218.	Subject Property Sales History and Property Flipping	F-104

TABLE OF CONTENTS

219.	Subject Property as a Comparable Sale	F-105
220.	Five-Year Sales History as an Assignment Condition.....	F-105
221.	Analysis of Subject Property Sales History.....	F-106
222.	Sales History for New Construction.....	F-106
223.	Appraisal Without Knowing Sale Price.....	F-107
224.	Analysis of Sales History for Comparable Sales.....	F-107
225.	Sales History Analysis for Deed in Lieu of Foreclosure	F-107
226.	Obligation to Analyze Prior Listings of Subject Property	F-108
227.	Proper Analysis of Agreement of Sale	F-108
228.	Obligation to Analyze Withdrawn Or Expired Listings	F-108
229.	Sales History Analysis in a Retrospective Appraisal.....	F-109
230.	Sales History Analysis for Condition And Marketability Reports.....	F-109
APPRAISAL REPORTING – CERTIFICATION AND SIGNATURES.....		F-111
231.	Reason for Signed Certification.....	F-111
232.	Changing the Certification.....	F-112
233.	Requirement for Signing Reports	F-112
234.	Signature on Letter of Transmittal.....	F-112
235.	Multiple Signatures on Appraisal Reports.....	F-113
236.	Signature Authorization.....	F-113
237.	Authorizing the Use of Your Digital Signature	F-114
238.	Providing Signature to Create a Signature File	F-114
239.	Losing Control of a Digital Signature	F-114
240.	Responsibility of an Appraiser Signing as a Supervisor.....	F-115
241.	Signing Digital (Electronic) Reports	F-115
242.	Business Entity Signing an Appraisal Report	F-115
243.	Significant Appraisal Assistance	F-115
244.	Significant Professional Assistance (NEW)	F-116
245.	Does USPAP Define Supervisory Appraiser?.....	F-117
246.	Reporting Significant Real Property Appraisal Assistance	F-118
247.	Relying on the Reports of Others (NEW).....	F-118
248.	Disagree With Supervisor on Value Conclusion	F-119
249.	Does the Certification on the Uniform Residential Appraisal Report (URAR) Form Also Extend to the Market Conditions Addendum?	F-119
250.	Multi-Discipline Certification – Real Property Appraiser.....	F120
251.	Relying on the Reports of Others	F-121
252.	Multi-Discipline Certification – Personal Property Appraiser	F-122
APPRAISAL REPORTING – USE AND FORMAT ISSUES		F-123
253.	Required Level of Detail in a Self-Contained Appraisal Report.....	F-123
254.	Ownership of Appraisal Reports	F-124
255.	Electronic Report Delivery.....	F-125

TABLE OF CONTENTS

256.	Identification of Report Option Used	F-125
257.	Appraisal Report Labeling Confusion	F-126
258.	Label Different from Reporting Options	F-126
259.	Is a Letter of Transmittal Part of an Appraisal Report?	F-127
260.	Copy of License in Appraisal Report	F-127
261.	Does USPAP Require Identifying Appraisal Credentials?	F-127
262.	Restricted Use Appraisal Report and Third Parties	F-127
263.	Appraisal Update Reporting Format.....	F-128
264.	Are Instant Messages or Text Messages Appraisal Reports?	F-128
265.	Reporting Appraisal Updates.....	F-128
266.	Fannie Mae Update Report Form 1004D/Freddie Mac Form 442.....	F-129
267.	Appraisal Report Content and Property Flipping	F-129
268.	Legal Description	F-130
269.	Property Address	F-130
270.	Why Report Scope of Work	F-131
271.	Reporting Work Not Done in an Assignment.....	F-131
272.	Separate Scope of Work Section in the Report?.....	F-132
273.	Identification of Intended Users in Appraisal Reports	F-132
274.	Identification of the Client in Appraisal Reports.....	F-132
275.	Disclosure of the Intended User in a Report.....	F-133
276.	Disclosure of the Intended Use in a Report	F-133
277.	Multiple Intended Uses in the Same Appraisal Report (NEW)	F-134
278.	Oral Reports And Record Keeping.....	F-134
279.	Communicating Assignment Results Without a Written Report.....	F-135
280.	Oral Appraisal Reporting Requirements.....	F-135
281.	Workfile Contents for an Oral Report	F-136
282.	Appraisal Report Form Software.....	F-136
283.	Paper Copies of Electronically Transmitted Reports.....	F-137
284.	Appraisal Report Forms Compliance With USPAP	F-137
285.	Fannie Mae/Freddie Mac Appraisal Report Forms And USPAP Compliance	F-137
286.	Standards, Standards Rules, And Reporting an Appraisal.....	F-140
287.	Application of Appraisal Reporting Requirements (NEW).....	F-140
288.	Discounted Cash Flow (DCF)	F-141
289.	Content of Restricted Use Appraisal Reports	F-141
290.	Appraiser Qualifications in Report.....	F-141
291.	Providing a Draft of a Report	F-142
292.	Developing an Unnecessary Valuation Approach	F-142
	APPRAISAL REVIEW	F-144
293.	When DOES Standard 3 Apply?	F-144
294.	Geographic Competency in Appraisal Reviews	F-144

TABLE OF CONTENTS

295.	Post-Valuation Date Information in Appraisal Reviews	F-145
296.	Reviewer Disagrees With Value Conclusion.....	F-145
297.	Reviewer Concurs With Value Conclusion.....	F-146
298.	Appraisal Review and State Appraiser Boards.....	F-147
299.	Reading Appraisal Reports.....	F-147
300.	Reviewing Two Appraisals on the Same Property	F-148
301.	Must a Review Appraiser Be Licensed Or Certified in the State Jurisdiction Where the Subject Property Is Located?.....	F-148
302.	Review Report on Multiple Appraisal Reports.....	F-149
303.	Appraisal Review for a State Appraiser Board.....	F-149
304.	Reviewing an Appraisal Review Report.....	F-149
305.	Scope of Work in Appraisal Review Reports.....	F-150
306.	Reviewing a Portion of an Appraisal Report.....	F-150
307.	Changing the Value Opinion Without the Appraiser’s Consent.....	F-150
308.	Reviewer’s Own Opinion of Value And Scope of Work.....	F-151
309.	Discrediting the Original Appraiser’s Work.....	F-151
310.	Reviewer Citation of USPAP Non-Compliance	F-152
311.	Review Appraiser Bias	F-152
312.	Is Compliance with Standard 3 Required When Submitting a Complaint?.....	F-152
313.	Uniform Act And the Review of Low Value Acquisition Appraisal Reports	F-153
314.	Effective Date That Differs From the Work Under Review	F-154
315.	Additional Certification in an Appraisal Review Report.....	F-154
OTHER SERVICES		F-156
316.	Value Opinion in an Appraisal Consulting Assignment.....	F-156
317.	Valuation Service Involving Advocacy.....	F-156
318.	Purpose of an Appraisal Consulting Assignment	F-157
319.	Feasibility Studies And Appraisal Practice	F-157
320.	Appraisal Versus Appraisal Consulting Assignment.....	F-158
321.	Which USPAP Standards Apply to Personal Property Appraisal Consulting?	F-159

USPAP Composition Structure and Compliance

1. ADVISORY OPINIONS NOT PART OF USPAP

Question: Is it true that the Advisory Opinions are not part of USPAP?

Response: Yes. The Advisory Opinions, which are distributed in the same publication as the Rules, Standards, and Statements, are identified as a form of **other communications** issued by the Appraisal Standards Board (ASB). Just like Frequently Asked Questions, Advisory Opinions are published to illustrate the applicability of appraisal standards in specific situations and to offer advice from the ASB for the resolution of appraisal issues and problems.

2. VALUATION SERVICE DEFINED

Question: What is a valuation service?

Response: Valuation services pertain to all aspects of property value and include services performed by both appraisers and by others. Valuation services can be performed by appraisers and any number of other professionals such as attorneys, accountants, insurance estimators, auctioneers, or brokers.

See Advisory Opinion 21, *USPAP Compliance* for further details.

3. RETIRING A PORTION OF USPAP

Question: What does it mean when the ASB retires a portion of USPAP?

Response: To retire a portion of USPAP means to withdraw it so it is no longer of force. The ASB is responsible for promulgating, developing, interpreting, and amending the *Uniform Standards of Professional Appraisal Practice*, as such, it can decide to retire any portion of USPAP if it does not reflect current practice, is no longer necessary or applicable, or is otherwise deficient.

It should be noted that the acronym USPAP is used by many to refer to a publication of The Appraisal Foundation, which includes more than the *Uniform Standards of Professional Appraisal Practice*. The Advisory Opinions and Frequently Asked Questions sections are not actually part of *the Uniform Standards of Professional Appraisal Practice*, even though they are bound within the same publication.

Since not all portions of the USPAP publication constitute appraisal standards or have the weight of an appraisal standard, not all parts of the document are subject to the same process of retirement. Retirement of those portions of USPAP that constitute appraisal standards (or that have the same weight as standards) must be exposed for a minimum of 30 days prior to any action by the ASB. This includes the DEFINITIONS, the PREAMBLE, RULES, Standards Rules, and Statements. The Advisory Opinions and Frequently Asked Questions can be adopted, removed, or modified by the ASB without prior notice.

4. THE PRIMARY PURPOSE OF USPAP

Question: What is the primary purpose of USPAP

Response: The purpose of USPAP is to promote and maintain a high level of public trust in professional appraisal practice. This concept is emphasized at the very beginning of the PREAMBLE:

*The purpose of the Uniform Standards of Professional Appraisal Practice (USPAP) is to **promote and maintain a high level of public trust** in appraisal practice by establishing requirements for appraisers. (Bold added for emphasis)*

The development of trust between the general public and the professional appraiser is not unique to the appraisal profession – it is also inherent in other professions such as medical practice and accountancy.

Contained within this notion of trust is a relationship that requires the professional to provide more than their skill or expertise. There is a distinct ethical obligation to act in the behalf of the public's interest, not out of self-interest. Because of the public interest aspect of the service the public must be able to trust that a professional will act in an ethical and competent manner.

Although the main purpose is not to protect appraisers, appraisers do receive significant benefits and protection from USPAP. It establishes requirements for impartiality, independence, objectivity, and competent performance. Because of these standards, appraisers who comply with USPAP are viewed as unbiased professionals whose work is worthy of public trust.

5. COMPLYING WITH USPAP BY CHOICE

Question: A client has asked me to develop an appraisal. I am not under any obligation by law, regulation, or by agreement with the client, to comply with USPAP for this particular assignment, but I would like to do so. Is this possible?

Response: Yes; you can voluntarily choose to perform an assignment under USPAP. The PREAMBLE states:

*Compliance with USPAP is required when either the service or the appraiser is obligated to comply by law or regulation, or by agreement with the client or intended users. When not obligated, individuals may still **choose** to comply. (Bold added for emphasis)*

Refer to Advisory Opinion 21, *USPAP Compliance* for further guidance.

6. COMPLIANCE WITH USPAP: PERSONAL PROPERTY, BUSINESS VALUATION AND INTANGIBLE ASSET APPRAISERS

Question: Are personal property, business valuation and intangible asset appraisers required to comply with USPAP?

Response: The PREAMBLE describes the obligation of all appraisers to act ethically:

The appraiser's responsibility is to protect the overall public trust and it is the importance of the role of the appraiser that places ethical obligations on those who serve in this capacity. USPAP reflects the current standards of the appraisal profession.

The PREAMBLE further states:

*USPAP does not establish who or which assignments must comply...Compliance with USPAP is required when either the service or the appraiser is obligated to comply by law or regulation, or by agreement with the client or intended users. **When not obligated, individuals may still choose to comply.** (Bold added for emphasis)*

A personal property, business valuation, or intangible asset appraiser's decision to comply may be prompted by choice, affiliation with a professional appraisal organization, or agreement with the client.

7. USPAP APPLICABILITY IN VALUATION FOR FINANCIAL REPORTING

Question: I am an appraiser in a firm that performs valuations of business interests and assets (both tangible and intangible) for financial reporting purposes in accordance with Financial Accounting Standards Board (FASB) standards. Does USPAP apply to valuations for financial reporting purposes?

Response: USPAP does not establish who or what assignments must comply with USPAP. Such requirements are established by law, regulation, or agreement with the client. Additionally certain professional organizations require that their members comply with USPAP.

Therefore, regarding *who* must comply: Individuals providing appraisals (defined in USPAP as an opinion of value) who fall under one of the above requirements must comply with USPAP in valuations for financial reporting.

And, regarding *what assignments* must comply: Appraisals that are required by law to comply with USPAP must comply regardless of whether the individual performing the appraisal would otherwise be required to comply. In some states, it is mandatory for real estate appraisals (an opinion of value of real estate) to comply with USPAP, no matter what the intended use.

Additionally, regardless of the intended use of the appraisal, individuals who hold themselves out as appraisers should comply.

It is important to note that, Fair Value assignments performed in compliance with Accounting Standards Codification (ASC) 805, *Business Combinations* (formerly Statement of Financial Accounting Standards No. 141R) issued by the Financial Accounting Standards Board, are often referred to as allocations. However, the asset values determined in these assignments are appraisals as defined in USPAP, as they are opinions of value. Therefore, these allocations must comply when the appraiser, or the assignment, is required by law, regulation, agreement of the

client, or when the appraiser belongs to a professional organization that requires compliance. In addition, any individuals holding themselves out to be appraisers should comply, even when not required to do so.

8. ASSIGNMENT INVOLVING ANALYSIS OF LEASES

Question: An investment firm hired an appraiser to abstract leases, input the data into a lease-by-lease analysis software program, estimate market rents and expenses, estimate the discount rate, run ten discounted cash flows, and provide a value using the Income Capitalization Approach. The appraiser completed the assignment, including providing a conclusion of market value, and delivered the electronic lease-by-lease analysis file to the client. Should this service comply with USPAP?

Response: Yes. This service is an appraisal. In order to be in compliance with USPAP, the appraiser must observe the development and reporting requirements applicable to a real property appraisal (STANDARDS 1 and 2). It is not possible to determine from the information provided whether the appraiser properly developed his or her assignment results. However, it does appear that the reporting of the assignment results fails to comply with STANDARD 2. USPAP prescribes the minimum content requirements for three real property appraisal reporting options: Self-Contained Appraisal Report, Summary Appraisal Report, and Restricted Use Appraisal Report. The communication of solely a lease-by-lease analysis file does not satisfy the reporting requirements of USPAP.

9. USPAP COMPLIANCE AS AN INSTRUCTOR

Question: In addition to my job as an appraiser, I spend a significant amount of my professional time as an instructor of appraisal courses and seminars. One of the prerequisites for my teaching position is that I must also be a practicing appraiser. Am I subject to USPAP when I am teaching appraisal courses?

Response: Yes. Since you are acting in the role of an appraiser in these teaching assignments, you are engaged in appraisal practice, which is defined in USPAP as:

*Valuation services performed by an individual acting as an appraiser, including, **but not limited to**, appraisal, appraisal review, or appraisal consulting.* (Bold added for emphasis)

While USPAP does not include Standards Rules for teaching assignments, you must observe applicable requirements in the PREAMBLE, the ETHICS RULE, the COMPETENCY RULE and the JURISDICTIONAL EXCEPTION RULE.

See Advisory Opinion 21, *USPAP Compliance* for discussion of the application of USPAP in valuation services.

10. PERSONAL PROPERTY APPRAISAL REQUIREMENTS

Question: I'm a personal property appraiser and I've been asked to donate my professional services to help raise funds for a charitable organization. The charity wants to hold an event where individuals can bring in their personal property items and, for a nominal fee that is paid to the charity, receive an oral report of my opinion as to the value of their item(s). This appears to be similar to television shows where people bring in their personal items to be valued. If I decide to participate, would my opinions be considered appraisals and if so, how could I comply with USPAP in performing these assignments?

Response: USPAP defines appraisal as:

the act or process of developing an opinion of value; an opinion of value.

Therefore, the opinions you describe would be appraisals.

To comply with USPAP, a personal property appraiser would have to comply with the requirements of STANDARD 7 and STANDARD 8, in addition to the applicable rules (e.g., the ETHICS RULE, the COMPETENCY RULE, the SCOPE OF WORK RULE). This means the appraiser would have to perform the level of research and analyses required to produce credible assignment results (given the intended use). Since the appraiser would be communicating the appraisal as an oral report, the report must address (to the extent that it is both possible and appropriate) the substantive matters of a Summary Appraisal Report. In addition, the appraiser would have to prepare a workfile as required by the RECORD KEEPING RULE.

These television shows may make it appear that the appraiser is providing his or her appraisal off the cuff and not in compliance with USPAP. However, it is more likely the appraiser has been provided with the personal property item to be appraised prior to the actual taping of the show. The appraiser may also be providing the property owner with a written appraisal report; although it may not be discussed during the television show. Therefore, it is possible the appraiser is rendering a USPAP-compliant appraisal and report, even if it does not appear that way during the airing of the show.

See Advisory Opinion 21, *USPAP Compliance* for further guidance.

11. USPAP COMPLIANCE WITH OTHER VALUATION STANDARDS

Question: I have been asked to perform an appraisal that complies with USPAP and with valuation standards from an international appraisal organization. If my appraisal complies with USPAP, will it automatically comply with other valuation standards as well?

Response: No. Although there are similarities between all major appraisal standards, it is impossible to say that compliance with USPAP ensures compliance with any other standards. It would be necessary to review the actual content of the valuation standards in question to determine whether different actions would be necessary to comply with those standards.

ETHICS RULE CONDUCT

12. DON'T ACCEPT UNLESS YOU CAN APPRAISE FOR \$XXX,000

Question: I received an appraisal order that says: “If you can't appraise the property for \$XXX,000, you must not accept the appraisal assignment.” How should I respond to this appraisal order?

Response: Accepting such an assignment would violate the Management section of the ETHICS RULE, which states, in part:

An appraiser must not accept an assignment, or have a compensation arrangement for an assignment, that is contingent on any of the following:

- 1. **the reporting of a predetermined result (e.g., opinion of value);***
- 2. a direction in assignment results that favors the cause of the client;*
- 3. the amount of a value opinion;*
- 4. the attainment of a stipulated result (e.g., that the loan closes or taxes are reduced); or*
- 5. the occurrence of a subsequent event directly related to the appraiser's opinions and specific to the assignment's purpose. (Bold added for emphasis)*

You could respond to this request with the following statement: “I cannot accept the assignment with this condition because it violates professional ethics. You should be aware that I must develop the appraisal before I will know the results. I can only accept the assignment if you remove the predetermined value requirement.”

Please refer to Advisory Opinion 19, *Unacceptable Assignment Conditions in Real Property Appraisal Assignments* for additional guidance on appraisal requests with conditions.

13. APPRAISER COERCION

Question: Does USPAP require an appraiser to certify in the appraisal report that he or she has not been coerced to provide predetermined results?

Response: No. However, such a statement would be consistent with the requirements of USPAP. Standards Rule 2-3 essentially requires the appraiser to certify that he or she has not been coerced, without specifically using that term. SR 2-3 requires the appraiser to certify, among other things, that:

my engagement in this assignment was not contingent upon developing or reporting predetermined results.

An appraiser would be unethical to affirm this statement in the certification if the appraiser had been coerced into providing predetermined assignment results.

14. PLAGIARISM**Question:** Is plagiarism considered unethical or improper?**Response:** Yes. Plagiarism is unethical. The Conduct section of the ETHICS RULE states that an appraiser must not use or communicate a misleading or fraudulent appraisal report. Presenting an appraisal report as yours when all or part is the work of someone else is clearly misleading.**15. USE OF QUALITATIVE TERMS****Question:** Does USPAP permit appraisers to use terms that reflect a scale, such as high, low, good, or the like?**Response:** Yes. USPAP does not prohibit the use of such qualitative terms in an appraisal report. However, the Conduct section of the ETHICS RULE states:

An appraiser must not use or rely on unsupported conclusions relating to characteristics such as race, color, religion, national origin, gender, marital status, familial status, age, receipt of public assistance income, handicap, or an unsupported conclusion that homogeneity of such characteristics is necessary to maximize value.

Appraisers should exercise care to avoid comments in a report that may be perceived as biased or illegally discriminatory. Factual descriptions and qualitative terms allow the user of a report to draw his or her own conclusions. The use of terms that reflect a scale such as high, low, good, fair, poor, strong, weak, rapid, slow, average or the like should also provide contextual information that properly explains the frame of reference and relative position of the subject property on the scale.

For example, if absorption is stated as rapid, the context of the rating should also be cited (rapid relative to what?). Additional guidance is provided in Advisory Opinion 16, *Fair Housing Laws and Appraisal Report Content*.

16. CONFLICTS OF INTEREST**Question:** The principals of a local mortgage company propose to acquire an appraisal firm and have the appraisal firm complete assignments for the mortgage company. Is this a conflict of interest for the appraisers completing assignments for the mortgage company?**Response:** An appraiser should review the ETHICS RULE and Standards Rule 2-3 when completing appraisal assignments in situations where the appraisal company that engages (by employment or contract) the appraiser is owned by the client.

It is important to note that USPAP does not prohibit the acceptance of an assignment in this specific situation. In an appraisal assignment developed under STANDARD 1 and reported under STANDARD 2, an appraiser must specify the particulars in a situation where he or she has any present or prospective interest with respect to the parties involved in the property that is the subject of the report.

The engagement of an appraiser by an appraisal company that is owned by the client or by owners of the client does not, in and of itself, mean that the appraiser has an interest or bias with respect to the property or parties involved. If the appraiser has an interest but could provide the service in an

ethical, unbiased manner, then the appraiser could accept the assignment as long as the appraiser was competent and properly disclosed the interest in accordance with Standards Rule 2-3.

If the appraiser's interest in the property or the parties involved in the assignment prevented the appraiser from providing an unbiased service, then the appraiser should not accept the assignment because it would be in violation of the ETHICS RULE and parts of the appraiser's certification in Standards Rule 2-3.

17. DISCLOSING PRIOR APPRAISAL OF A PROPERTY (NEW)

Question: I occasionally receive requests to appraise a property that I have appraised in the past. Since the ETHICS RULE requires me to disclose any assignments that I performed within the three years prior to the date of acceptance of the assignment, isn't such a disclosure a violation of an appraiser's responsibility under the Confidentiality section of the ETHICS RULE?

Response: Generally, no. The Confidentiality section of the ETHICS RULE prohibits, with some exceptions, the disclosure of "confidential information or assignment results prepared for a client." The mere fact that an appraiser appraised a property is not confidential information as defined in USPAP. However, the appraiser must be careful not to disclose confidential information from a previous assignment in the new assignment.

18. DISCLOSURE REQUIREMENTS WHEN AN APPRAISER HAS NOT PERFORMED SERVICES REGARDING A PROPERTY IN THE PRIOR THREE YEARS (NEW)

Question: I am aware of the disclosure requirements in the Conduct section of the ETHICS RULE that requires me to disclose any services I performed regarding the subject property within the prior three years. If I have not performed any such services, am I required to make that disclosure as well?

Response: Yes. Standards Rules 2-3, 5-3, 6-9, 8-3, and 10-3 require the signed certification to include a statement, similar in content to the following, with each report:

I have performed no (or the specified) services, as an appraiser or in any other capacity, regarding the property that is the subject of this report within the three-year period immediately preceding acceptance of this assignment.

In addition, Standards Rule 3-6 requires the signed certification to include a statement similar in content to the following, with each appraisal review report:

I have performed no (or the specified) other services, as an appraiser or in any other capacity, regarding the property that is the subject of the work under review within the three-year period immediately preceding acceptance of this assignment.

Therefore, each assignment must include a disclosure regarding prior services performed within the past three years, whether any services were provided or not.

19. DISCLOSURE OF ANY PRIOR SERVICES REGARDING THE SUBJECT PROPERTY, WHEN AN APPRAISER HAS APPRAISED THE PROPERTY MULTIPLE TIMES (NEW)

Question: If I have appraised a property multiple times within the previous three years, do I have to disclose the *number* of appraisal services? (e.g., “I have appraised the subject property three times during the previous three years.”)

Response: Yes. Each prior service must be disclosed to the client and included in the report certification. This disclosure is similar to when an appraiser has any current or prospective interest in the subject property or the parties involved, which requires that each interest be specified. Therefore, each service must be disclosed to the client and appear in the certification. (See lines 231-241 in the 2012-13 edition of USPAP)

20. DISCLOSING ADDITIONAL INFORMATION REGARDING A PRIOR APPRAISAL (NEW)

Question: I am concerned that when I tell a prospective client that I have previously provided a service related to a property, it will lead to questions that I cannot answer without violating the Confidentiality section of the ETHICS RULE. I am sure the new client will want to know when I appraised it, and what my value conclusion had been. How can I address these questions and comply with USPAP?

Response: It is possible that some potential clients will ask such questions. However, without authorization from the original client, the appraiser cannot disclose the results of the previous appraisal or any other confidential information. One way to address this problem would be to explain that as an appraiser, you are subject to confidentiality requirements and cannot disclose that information. You could go on to explain that the confidentiality requirements are in place to protect clients, including the one who is engaging you for the new assignment.

21. CLIENT REQUIREMENT TO MAINTAIN CONFIDENTIALITY (NEW)

Question: Some of my best clients require me to keep all information regarding any assignments that I perform for them confidential. The Comment in the Conduct section of the ETHICS RULE states, in part, “If an appraiser has agreed with a client not to disclose that he or she has appraised a property, the appraiser must decline all subsequent assignments that fall within the three-year period.” Will this prevent me from appraising a property for a *different* client during that three-year period?

Response: Perhaps. The requirement states, in part, “...an appraiser must disclose...any services...performed by the appraiser...” The appraiser is not required to disclose specific details beyond noting the *type* of service. For example, the disclosure, both prior to accepting the assignment and in the report’s certification, could include a statement similar to one of the following:

“I have performed (*note type of services(s)*) regarding the subject property within the three years prior to this assignment”; or

“I have previously appraised this property in the three years prior to this assignment.”

If an appraiser cannot make such a statement without violating an agreement with a previous client, the appraiser must not accept the new assignment. Appraisers should review their client agreements to specifically determine what information they have agreed to keep confidential

22. DISCLOSURE OF ANY PRIOR SERVICES REGARDING THE SUBJECT PROPERTY BEFORE ACCEPTING AN ASSIGNMENT, WHEN THE CLIENT HAD PREVIOUSLY REQUIRED AN APPRAISER TO SIGN A CONFIDENTIALITY AGREEMENT (NEW)

Question: The Comment to the Conduct section of the ETHICS RULE states, in part, “If an appraiser has agreed with a client not to disclose that he or she has appraised a property, the appraiser must decline all subsequent assignments that fall within the three-year period.” Does this really mean that the appraiser could not be engaged by this same client, on this property, within the three-year period?

Response: Yes. The agreement not to disclose that he or she has appraised the property is between an appraiser and the client. It is possible that a qualified legal opinion might conclude that a confidentiality agreement between an appraiser and a client does not preclude disclosure between the same parties. However, the ASB is not qualified to make such a determination. Without such a legal opinion, the requirement precludes an appraiser from disclosing the prior service and from appraising the property again during this three-year disclosure period.

However, there is nothing that prohibits a client and an appraiser from modifying the prior agreement to allow disclosure. If the confidentiality agreement is amended, the disclosure could be made and an appraisal could be completed for the same client or another client. It must be made clear that if a client releases an appraiser from such a confidentiality agreement, services performed within the previous three-year period *must be disclosed* in the certification of the subsequent report, even if the client is the same for both assignments.

23. DISCLOSURE OF ANY PRIOR SERVICES REGARDING THE SUBJECT PROPERTY BEFORE ACCEPTING AN ASSIGNMENT, WHEN THE APPRAISER ONLY WORKS FOR ONE CLIENT (NEW)

Question: I am a staff appraiser for a company and only complete appraisals for my employer’s (the company’s) internal use. Am I required to inform the company that I have previously completed an appraisal within the three-year period when the company is already aware of it?

Response: If you consistently correspond with the same person in the company when completing subsequent assignments regarding the same property, the risk of misleading that person is probably minimal. However, your prior services must still be disclosed. When you are working with the same person and they understand your professional responsibilities, it is unlikely this will be a problem.

It is also possible that the specific person you deal with from one instance to the next may change. In this case, the new contact must certainly be informed if you have performed services regarding the subject property within the last three years.

While it is not included in your question, there is also the possibility that you may have performed services regarding that property for a different client within the three-year period, or performed another type of service.

24. DISCLOSURE OF ANY PRIOR SERVICES REGARDING THE SUBJECT PROPERTY, WHEN AN APPRAISER HAS PERFORMED SERVICES OTHER THAN APPRAISAL PRACTICE (NEW)

Question: If I have performed a service other than appraisal practice, such as acting as a general contractor within the prior three years, do I have to describe the specific service or merely state a service was performed?

Response: You must disclose to the client the type of prior service you performed regarding the property and this must be included in the report certification. This disclosure is not limited to services provided as part of appraisal practice. Therefore, each service must be disclosed to the client and appear in the certification.

25. DISCLOSING PRIOR SERVICES MORE THAN THREE YEARS AGO (NEW)

Question: The Conduct section of the ETHICS RULE requires that I disclose prior services regarding the subject property provided within the three years prior to acceptance of an assignment. I am appraising a residential property on which I acted as the general contractor when it was built four years ago. Since this service was more than three years ago, am I correct in not disclosing that to a new client?

Response: USPAP establishes a minimum standard of three years, and that is what you are required to disclose. However, an appraiser should disclose previous services that occurred prior to the three years when the appraiser believes it may be relevant.

26. DISCLOSING PRIOR SERVICES PROVIDED BY MY COMPANY (NEW)

Question: If the firm that employs me as an appraiser has provided leasing or property management services in the past three years for the subject property, must this be disclosed?

Response: Not necessarily. The ETHICS RULE requires disclosure of services “provided by the appraiser.” However, if an appraiser believes that the provision of a service by the appraiser’s firm or other related entity may be relevant, he or she should disclose that information to a potential client.

27. DISCLOSING PROSPECTIVE INTEREST IN A PROPERTY (NEW)

Question: If I will be conducting an auction of the subject property after the appraisal, does this have to be disclosed?

Response: Yes. This is an example of a “current or prospective interest in the subject property.” USPAP requires that such an interest be disclosed in the certification and prior to acceptance of an assignment or upon discovery during the assignment.

28. DISCLOSING PRIOR SERVICES ON PRE-PRINTED FORM REPORTS (NEW)

Question: Most of my assignments are completed using common residential appraisal report forms. I am concerned that my clients do not allow changes to the certification on the report forms. The Conduct section of the ETHICS RULE requires that I disclose whether or not prior services were performed regarding the subject property at the time of engagement, and in the certification of the report. Does this mean that I will not be allowed to appraise a property for these clients if I had performed a service regarding that property in the previous three years?

Response: USPAP compliance is the appraiser's responsibility and adding this information to the certification was required as of January 1, 2010. While deletion or modification of client-imposed certifications may not always be allowed, most clients allow additional certifications that do not constitute material alterations to the appraisal report. It is not uncommon for appraisers to add supplemental certifications and this will be necessary unless and until such forms are revised to comply with the requirements of Standards Rule 2-3.

29. IS THERE A SPECIFIED FORMAT FOR DISCLOSING PRIOR SERVICES AT THE TIME OF ASSIGNMENT? (NEW)

Question: May the disclosure that must be made at the time of acceptance be oral? May it be made in an email to the client?

Response: USPAP does not specify how the disclosure upon acceptance or discovery must be made. It may be appropriate in some cases to provide an initial oral disclosure. If the client decides to proceed, it may be appropriate that the appraiser's disclosure be restated in writing. One way to accomplish this is by including it in a letter of engagement. In other cases an email would be appropriate.

The RECORD KEEPING RULE requires that the appraiser's workfile include "all data, information, and documentation necessary to...show compliance with this Rule..." So, the disclosure prior to acceptance or upon discovery must be documented in the appraiser's workfile.

30. VALUE OPINIONS THAT EQUAL CONTRACT PRICES

Question: I know appraisers who consistently conclude that the market value of any property they appraise is equal to the contract sales price. In doing so, they facilitate sales and financing of sales, which is apparently what keeps their clients happy. Is this a violation of USPAP?

Response: A contract sale price can be a good indicator of a property's market value, and it may be logical and reasonable for the appraiser to conclude that they are the same. However, this is not always the case. In some situations, a contract price will exceed what is typical in a market. In other situations, a contract price will be less than what is typical. A contract sale price, while a significant piece of market data, must not become a target in an appraisal assignment. Rather, competent analysis of relevant and credible market data must be the appraiser's basis for a market value conclusion.

If an appraiser consistently concludes that the contract sale price of any property they appraise equals market value, particularly when a competent analysis of credible market data indicates otherwise, the appraiser's impartiality, objectivity and independence appear to have been

compromised. The ETHICS RULE clearly prohibits such a practice. The Conduct section of the ETHICS RULE includes the following statements:

An appraiser must perform assignments with impartiality, objectivity, and independence, and without accommodation of personal interests.

An appraiser must not perform an assignment with bias.

An appraiser must not advocate the cause or interest of any party or issue.

An appraiser must not accept an assignment that includes the reporting of predetermined opinions and conclusions.

An appraiser must not use or communicate a report that is known by the appraiser to be misleading or fraudulent.

An appraiser must not knowingly permit an employee or other person to communicate a misleading or fraudulent report.

The Management section of the ETHICS RULE also states that:

An appraiser must not accept an assignment, or have a compensation arrangement for an assignment, that is contingent on any of the following:

1. ***the reporting of a predetermined result (e.g., opinion of value);***
2. ***a direction in assignment results that favors the cause of the client;***
3. *the amount of a value opinion;*
4. *the attainment of a stipulated result (e.g., that the loan closes or taxes are reduced); or*
5. *the occurrence of a subsequent event directly related to the appraiser's opinions and specific to the assignment's purpose. (Bold added for emphasis)*

An appraiser must develop an opinion of market value impartially and objectively. An appraiser who selects only data that complements a contract sale price or analyzes data in a manner to purposefully support a contract sale price violates the ETHICS RULE.

31. PROPERTY FLIPPING

Question: What is property flipping?

Response: The terms property flipping or flip are commonly used to describe the transfer of property where fraud is used to obtain inflated prices and loans.

It is important to note that property flipping is distinctly different from the usual activity of buying and selling property at a profit. The market for real estate is imperfect. Knowledgeable and honest parties seek opportunities to acquire a given property at a favorable price with the objective of reselling that property at a profit. Such activity does not constitute flipping as there is no intent to mislead or defraud.

USPAP does not describe property flipping itself, but it does prohibit appraisers from communicating assignment results in a fraudulent or misleading manner. The ETHICS RULE is explicit about any kind of activity designed to mislead or defraud, as specified in the Conduct section of the ETHICS RULE:

An appraiser must perform assignments with impartiality, objectivity, and independence, and without accommodation of personal interests.

An appraiser must not perform an assignment with bias.

An appraiser must not advocate the cause or interest of any party or issue.

An appraiser must not accept an assignment that includes the reporting of predetermined opinions and conclusions.

An appraiser must not use or communicate a report that is known by the appraiser to be misleading or fraudulent.

An appraiser must not knowingly permit an employee or other person to communicate a misleading or fraudulent report.

The Management section of the **ETHICS RULE** also states that:

An appraiser must not accept an assignment, or have a compensation arrangement for an assignment, that is contingent on any of the following:

- 1. **the reporting of a predetermined result (e.g., opinion of value);***
- 2. **a direction in assignment results that favors the cause of the client;***
- 3. **the amount of a value opinion;***
- 4. **the attainment of a stipulated result (e.g., that the loan closes or taxes are reduced); or***
- 5. **the occurrence of a subsequent event directly related to the appraiser's opinions and specific to the assignment's purpose.** (Bold added for emphasis)*

32. ARE CONDITION AND MARKETABILITY REPORTS COVERED BY USPAP?

Question: I am a state certified appraiser and was recently asked by a client to perform a condition and marketability report. A value conclusion is not requested as part of the assignment; however, I must sign the report as an appraiser. Is this assignment covered by USPAP?

Response: Yes. Since the condition and marketability of a property directly pertains to its value, this is a valuation service. Furthermore, because you are being asked to perform the service as an appraiser, the assignment involves appraisal practice. USPAP defines appraisal practice as:

*valuation services performed by an individual acting **as an appraiser**, including but not limited to appraisal, appraisal review, or appraisal consulting.*

Comment: Appraisal practice is provided only by appraisers, while valuation services are provided by a variety of professionals and others. The terms appraisal, appraisal review, and appraisal consulting are intentionally generic and are not mutually exclusive. For example, an opinion of value may be required as part of an appraisal review and is required as a component of the analysis in an appraisal consulting assignment. The use of other nomenclature for an appraisal, appraisal review, or appraisal consulting assignment (e.g., analysis, counseling, evaluation, study, submission, or valuation) does not exempt an appraiser from adherence to the Uniform Standards of Professional Appraisal Practice. (Bold added for emphasis)

Appraisers who provide appraisal practice services for which there are no specific performance standards must comply with the portions of USPAP that still apply generally to appraisal practice. These include the PREAMBLE, the ETHICS RULE, the COMPETENCY RULE, and the JURISDICTIONAL EXCEPTION RULE (See Advisory Opinion 21, *USPAP Compliance* for further advice.)

33. SUPPORTED AND UNSUPPORTED CONCLUSIONS

Question: The Conduct section of the ETHICS RULE states, in part:

An appraiser must not use or rely on unsupported conclusions relating to characteristics such as race, color, religion, national origin, gender, marital status, familial status, age, receipt of public assistance income, handicap, or an unsupported conclusion that homogeneity of such characteristics is necessary to maximize value.

Does this imply that relying on supported conclusions relating to characteristics such as race, color, religion...is acceptable?

Response: No. One cannot infer by logical extension that using **supported** conclusions relating to characteristics such as race, color, religion, national origin, gender, marital status, age... is appropriate or acceptable. Additionally, USPAP recognizes that there may be laws and/or regulations that apply to this issue. In such cases, Advisory Opinion 16 (AO-16), *Fair Housing Laws and Appraisal Report Content*, makes it clear that an appraiser must be aware of, and must abide by, applicable laws. Specifically, AO-16 states, in part:

In some cases, even supported conclusions in assignments relating to characteristics such as race, color, religion, national origin, gender, marital status, familial status, age, receipt of public assistance income, handicap, or group homogeneity cannot be used because they are precluded by applicable law...

An appraiser must ensure that his or her appraisal, appraisal review, or appraisal consulting opinions and conclusions are impartial and objective and do not illegally discriminate or contribute to illegal discrimination through subjective or stereotypical assumptions.

34. UNACCEPTABLE ASSIGNMENT CONDITIONS – NONDISCLOSURE OF FACTS

Question: I have an assignment that involves a tract of land that is improved with two structures. However, the client has requested that I appraise the underlying land and only one of the two structures, without mentioning the other structure. Is it ethical to not disclose the presence of the second structure?

Response: No. The Conduct section of the ETHICS RULE states:

An appraiser must not use or communicate a report that is known by the appraiser to be misleading or fraudulent.

An appraiser must not knowingly permit an employee or other person to communicate a misleading or fraudulent report.

In the situation described, performing an appraisal without disclosing the existence of both structures in the report would be misleading.

ETHICS RULE MANAGEMENT

35. FEES PAID FOR PROCUREMENT OF AN ASSIGNMENT

Question: It has come to my attention that a local appraiser is paying a home inspection firm a \$25.00 referral fee for each appraisal assignment the home inspector refers to the appraiser. Are appraisers required by USPAP to disclose the payment of cash or other things of value to clients in order to obtain assignments?

Response: Yes. The Management section of the ETHICS RULE states that:

An appraiser must disclose that he or she paid a fee or commission, or gave a thing of value in connection with the procurement of an assignment.

Comment: The disclosure must appear in the certification and in any transmittal letter in which conclusions are stated; however, disclosure of the amount paid is not required. In groups or organizations engaged in appraisal practice, intra-company payments to employees for business development do not require disclosure.

36. COUPONS FOR PRICE DISCOUNTS

Question: Is it a violation of USPAP to offer as a marketing tool for my services a coupon for a 10% discount off the cost of an appraisal to potential clients such as mortgage lenders and the general public?

Response: No. The use of a coupon as a marketing tool would not be a violation of the ETHICS RULE. However, a coupon for a reduced fee would be a thing of value connected to the procurement of an assignment. Therefore, proper disclosure must be made in the certification of the report and in any transmittal letter in which value conclusions are stated.

The Management section of the ETHICS RULE states:

An appraiser must disclose that he or she paid a fee or commission, or gave a thing of value in connection with the procurement of an assignment.

Comment: The disclosure must appear in the certification and in any transmittal letter in which conclusions are stated; however, disclosure of the amount paid is not required. In groups or organizations engaged in appraisal practice, intra-company payments to employees for business development do not require disclosure.

37. PAYMENT OF FEES TO BE INCLUDED ON APPROVED APPRAISERS LIST

Question: Is it ethical for an appraiser to pay a fee to be included on a lender's approved appraiser list?

Response: Yes. It is ethical for appraisers to pay a fee to be included on a lender's approved appraiser list provided the appraiser discloses payment of a fee in his or her appraisal reports.

The Management section of the ETHICS RULE states that:

An appraiser must disclose that he or she paid a fee commission, or gave a thing of value in connection with the procurement of an assignment.

***Comment:** The disclosure must appear in the certification and in any transmittal letter in which conclusions are stated; however, disclosure of the amount paid is not required. In groups or organizations engaged in appraisal practice, intra-company payments to employees for business development do not require disclosure. (Bold added for emphasis)*

38. CONDUCTING DRAWINGS TO PROCURE APPRAISAL ASSIGNMENTS

Question: Is it a violation of USPAP for an appraisal firm to conduct a random drawing with prizes and allow clients a certain number of entries in the drawing that is based on the number of appraisals ordered within a certain period of time?

Response: This is not a violation if proper disclosure is made. The payment of **undisclosed** fees, commissions or things of value in the procurement of appraisal assignments is unethical, as stated in the Management section of the ETHICS RULE:

An appraiser must disclose that he or she paid a fee or commission, or gave a thing of value in connection with the procurement of an assignment.

An entry into a drawing would be considered a thing of value. The Comment further states that:

The disclosure must appear in the certification and in any transmittal letter in which conclusions are stated; however, disclosure of the amount paid is not required.

39. REDUCING APPRAISAL FEES WHEN TRANSACTIONS FAIL TO CLOSE

Question: Is it ethical for an appraiser to offer a client a reduced fee on an appraisal if the client's loan does not close?

Would the result be different if the client agreed to pay extra for other assignments?

Response: Neither practice would be ethical. Offering a client a reduced fee on an appraisal if the client's loan does not close is a violation of the ETHICS RULE. The Management section of the ETHICS RULE states:

An appraiser must not accept an assignment, or have a compensation arrangement for an assignment, that is contingent on any of the following:

1. *the reporting of a predetermined result (e.g., opinion of value);*
2. *a direction in assignment results that favors the cause of the client;*
3. *the amount of a value opinion;*
4. ***the attainment of a stipulated result (e.g., that the loan closes or taxes are reduced); or***
5. ***the occurrence of a subsequent event directly related to the appraiser's opinions and specific to the assignment's purpose. (Bold added for emphasis)***

Standards Rule 2-3, 3-6, 5-3, 6-9, 8-3, or 10-3, as applicable, also requires an appraiser to state that their compensation for completing the assignment is not contingent upon a subsequent event. Being paid an extra amount for other assignments does not change this result.

40. APPRAISAL FEES AS PERCENTAGES OF VALUE CONCLUSIONS

Question: Is it acceptable for an appraisal fee to be based on a percentage of the value conclusion?

Response: No. The Management section of the ETHICS RULE states:

An appraiser must not accept an assignment, or have a compensation arrangement for an assignment, that is contingent on any of the following:

1. *the reporting of a predetermined result (e.g., opinion of value);*
2. *a direction in assignment results that favors the cause of the client;*
3. ***the amount of a value opinion;***
4. *the attainment of a stipulated result (e.g., that the loan closes or taxes are reduced); or*
5. *the occurrence of a subsequent event directly related to the appraiser's opinions and specific to the assignment's purpose. (Bold added for emphasis.)*

This is reiterated in the signed certification (Standards Rule 2-3, 3-6, 5-3, 6-9, 8-3, and 10-3) that must be included in each appraisal, appraisal review, or appraisal consulting report.

41. APPRAISAL FEE IS CONTINGENT ON THE APPRAISED VALUE

Question: A potential client has asked me to complete a form indicating what my appraisal fees would be for different assignments. The form asks me to indicate my appraisal fees according to appraised value, e.g., to list the fee for assignments with appraised values between \$100,000 and \$299,000, \$300,000 to \$499,000, etc. Is it a violation of USPAP to quote fees in this manner?

Response: Yes. This is in violation of USPAP. Completing and submitting such a form to a potential client establishes a compensation arrangement for assignments that is contingent on the amount of the value opinion. This is prohibited by the Management section of the ETHICS RULE, which states, in part:

An appraiser must not accept an assignment, or have a compensation arrangement for an assignment, that is contingent on any of the following:

1. *the reporting of a predetermined result (e.g., opinion of value);*
2. *a direction in assignment results that favors the cause of the client;*
3. ***the amount of a value opinion;***
4. *the attainment of a stipulated result (e.g., that the loan closes or taxes are reduced); or*
5. *the occurrence of a subsequent event directly related to the appraiser's opinions and specific to the assignment's purpose. (Bold added for emphasis.)*

42. APPRAISER'S FEES BASED ON PENDING SALE PRICE

Question: I'm aware that an appraiser's fee cannot be based on the amount of the appraiser's value conclusion. However, does USPAP allow an appraiser's fee to be based on the amount of the owner's estimate or a pending sale price of the subject property?

Response: USPAP does not prohibit an appraiser's fee from being based on an owner's estimate, a pending sale price of the subject property, loan amount, or any other factor outside the appraiser's control.

This is in contrast to a fee based on the amount of the appraiser's opinion of value, which is within the appraiser's control. A fee arrangement based on the appraiser's opinion of value violates the ETHICS RULE.

43. DISCOUNTED APPRAISAL FEES

Question: Is it a violation of USPAP to offer reduced appraisal fees for clients that send me a large volume of business? Could I also offer a discount for the method of payment, such as collecting the fee from the borrower at the time of inspection?

Response: An appraiser may establish his or her fees based on a number of factors, including the amount of business received, business relationships, method of payment, and client-specific requirements. However, appraisers must ensure that they comply with the Management section of the ETHICS RULE.

44. DISCLOSURE OF REFERRAL FEE AMOUNTS

Question: The Management section of the ETHICS RULE requires an appraiser to disclose *...fees, commissions, or a thing of value...* paid in connection with the procurement of an assignment. If a referral fee was paid in conjunction with an assignment, must the amount of the fee be disclosed, or is it sufficient to simply disclose that a fee was paid?

Response: Disclosing the fact that a payment was made in the appraisal certification and any transmittal letter where the conclusions are stated is sufficient to meet the requirement. However, this is a minimum requirement and does not prohibit full disclosure of the amount of the fee.

45. RECIPROCAL BUSINESS ARRANGEMENTS

Question: A new bank client recently sent me a letter acknowledging that my firm is approved to conduct appraisal assignments for their company. It goes on to state that we are now preferred providers and expresses the bank's desire to embark on a mutually beneficial long-term relationship. The letter ends with a solicitation for my firm's banking business as part of this mutually beneficial relationship. I would like to make them happy because they could provide my firm a great deal of business. If I bring my banking business to this company, while I'm engaged as an appraiser, would I be violating USPAP?

Response: The answer to this question depends on whether the bank's approval of your firm as a preferred provider is conditional on you moving your banking business to that bank. The Management section of the ETHICS RULE states:

An appraiser must disclose that he or she paid a fee or commission, or gave a thing of value in connection with the procurement of an assignment.

Comment: The disclosure must appear in the certification and in any transmittal letter in which conclusions are stated; however, disclosure of the amount paid is not required. In groups or organizations engaged in appraisal practice, intra-company payments to employees for business development do not require disclosure.

If the lender has stated that your firm can only have their appraisal business if you bank with them, this relationship must be disclosed as described in the ETHICS RULE.

However, if the client is merely soliciting your business as it would any other potential customer, and you subsequently moved your banking business to that bank, there is no requirement in USPAP to disclose your banking relationship.

46. DOES USPAP APPLY IF THERE IS NO ASSIGNMENT FEE?

Question: I am an appraiser who performs appraisal, appraisal review, and appraisal consulting assignments, and I am required to comply with USPAP. I have been asked to perform one such assignment without charging a fee. Is my requirement to comply with USPAP impacted if I do not charge a fee?

Response: No. The applicability of USPAP is not affected by the amount of the fee, or lack of a fee.

47. CAN APPRAISERS PERFORM COMP CHECK ASSIGNMENTS FOR FREE?

Question: Does USPAP allow appraisers to perform comp check assignments for free?

Response: Yes. However, the appraiser would have to ensure that receiving a full appraisal assignment is not contingent upon the result of the comp check assignment. The Management section of the ETHICS RULE states, in part:

It is unethical for an appraiser to accept an assignment, or to have a compensation arrangement for an assignment, that is contingent on any of the following:

- 1. the reporting of a predetermined result (e.g., opinion of value);*
- 2. a direction in assignment results that favors the cause of the client;*
- 3. the amount of a value opinion;*
- 4. the attainment of a stipulated result (e.g., that the loan closes, or taxes are reduced) ; or*
- 5. the occurrence of a subsequent event directly related to the appraiser's opinions and specific to the assignment's purpose. (Bold added for emphasis.)*

48. IS DISCLOSURE OF A FREE COMP CHECK ASSIGNMENT REQUIRED?

Question: If I perform a free comp check assignment and my client subsequently requests me to perform a full (or traditional) assignment on the same property, do I have to disclose the free comp check assignment as having provided a thing of value to procure the new assignment?

Response: No. The Management section of the ETHICS RULE states, in part:

An appraiser must disclose that he or she paid a fee or commission, or gave a thing of value in connection with the procurement of an assignment.

Since USPAP prohibits the second assignment from being contingent upon the first, the free comp check could not be considered part of procuring the second assignment. Disclosure of the free comp check assignment would not be required as a “thing of value.” However, the Conduct section of the ETHICS RULE requires disclosure of all prior services performed related to the subject property within the prior three years.

An appraiser can provide a free comp check. An appraiser must not provide a free comp check and the pursuant appraisal if the engagement was contingent upon developing or reporting predetermined results.

49. APPRAISAL FEE PAID AT CLOSE OF FINANCING TRANSACTION

Question: I have a potential lending client that wants to arrange for my appraisal fees to be paid at the closing of each financing transaction. Does USPAP permit this fee arrangement?

Response: USPAP does not address the time frame for payment of fees. In the situation described there must be a clear agreement that the fee cannot depend on the closing of the financing transaction. Accepting an assignment where the appraisal fee is paid *only* upon successful closing of the transaction is a violation of the Management section of the ETHICS RULE:

An appraiser must not accept an assignment, or have a compensation arrangement for an assignment, that is contingent on any of the following:

1. the reporting of a predetermined result (e.g., opinion of value);
2. a direction in assignment results that favors the cause of the client;
3. the amount of a value opinion;
4. **the attainment of a stipulated result (e.g., that the loan closes or taxes are reduced); or**
5. **the occurrence of a subsequent event directly related to the appraiser’s opinions and specific to the assignment’s purpose. (Bold added for emphasis.)**

One way appraisers can avoid any ambiguity is by having a written agreement with the client detailing the manner in which the appraisal fee will be paid if the transaction does not close.

50. **COLLECTING FEE ON BEHALF OF AN AMC (NEW)**

Question: I am completing an appraisal assignment in which I was engaged by an Appraisal Management Company (AMC) on behalf of a lender. The AMC has asked me to collect a fee from the prospective borrower. I am to retain my portion of the total amount collected as the fee for my appraisal services, and forward the balance to the AMC. The AMC requires that there is to be no disclosure in the report of the total fee, nor of the manner in which the fee is to be split. Does USPAP permit this type of fee arrangement?

Response: If there was no compensation to procure the assignment, there is no USPAP requirement that the split of the total fee paid for the assignment must be disclosed in the report.

However, in this case, more information must be known in order to make a determination as to whether you are paying a fee to procure the assignment. Consider the following excerpt from the Management section of the ETHICS RULE:

*The payment of **undisclosed** fees, commissions, or things of value in connection with the procurement of an assignment is unethical. (Bold added for emphasis)*

The Comment to the Management section goes on to say:

Disclosure of fees, commissions, or things of value connected to the procurement of an assignment must appear in the certification and in any transmittal letter in which conclusions are stated.

As you can see from this USPAP excerpt, the first step is to determine if you, as the appraiser, paid a fee to procure the assignment. The decision would depend on the specific facts of your appraisal engagement agreement with the client (for which the AMC is acting as agent).

If you did not pay a fee to procure the assignment, then no disclosure is necessary. Simply collecting funds from one party on behalf of another party is not, in and of itself, representative of paying a fee for procurement of the assignment.

Of course, if the specific facts of the appraisal engagement agreement with the client lead you or others to believe a fee was paid for procurement of the assignment, disclosure that a fee was paid is required in the certification and any transmittal letter in which your conclusions are stated.

There may be other laws or regulations that enter into this situation. You should be familiar with any laws and regulations addressing fee arrangements in your particular jurisdiction.

ETHICS RULE – CONFIDENTIALITY

51. REPORTING OF ADVERSE CONDITIONS

Question: I just inspected a property and found an adverse condition. I informed my client (a bank), and was told not to proceed because the client cannot lend on such property. Under USPAP, am I obligated to inform any other party, such as the city or county health department?

Response: No.

52. DUE PROCESS OF LAW (NEW)

Question: I am a personal property appraiser that specializes in the appraisal of coins and currency. I am required, by federal law, to report United States counterfeit coins and currency to the U.S. Secret Service. In reporting these counterfeit coins and currency, I am also required under federal law to provide them with the name and contact information of my client. Would disclosing my client's name under these circumstances be a jurisdictional exception under USPAP?

Response: No, this issue does not constitute a jurisdictional exception. The Confidentiality section of the ETHICS RULE in USPAP prohibits an appraiser from disclosing *confidential information* (as defined in USPAP). However, it is not a violation of USPAP to disclose the name of the appraiser's client. Exceptions would be if the client's name qualified as *confidential information* (as defined in USPAP), or if the appraiser contractually agreed with the client not to disclose the client's name.

Even if the appraiser agreed not to disclose the name of the client, the Confidentiality section of the ETHICS RULE permits the appraiser to disclose the client's name to "such third parties as may be authorized by due process of law." If federal law mandates an appraiser to communicate confidential information, the appraiser must comply with that law.

53. DISCLOSING RESULTS OF APPRAISAL ASSIGNMENTS

Question: I have been asked by my client's business associate for information relating to an appraisal report I prepared for my client. Can I disclose the results of an appraisal assignment to parties other than the client?

Response: You can, but *only* if you receive authorization from the client before sharing assignment results with the client's associate. The Confidentiality section of the ETHICS RULE states, in part:

An appraiser must protect the confidential nature of the appraiser-client relationship.

An appraiser must not disclose: (1) confidential information or (2) assignment results to anyone other than:

- *the client;*
- *persons specifically authorized by the client;*

- *state appraiser regulatory agencies;*
- *third parties as may be authorized by due process of law; and*
- *a duly authorized professional peer review committee except when such disclosure to a committee would violate applicable law or regulation. (Bold added for emphasis.)*

54. APPRAISAL REPORT RECEIVED BY OTHERS

Question: I was recently contacted by a lender regarding an appraisal I had performed for another client. The lender had somehow obtained a copy of my appraisal report and had some questions they wanted me to answer. However, this lender was not my original client and was not named as an intended user. Are there any USPAP prohibitions against discussing my appraisal with this lender?

Response: Yes. USPAP prohibits the appraiser from communicating *assignment results* or *confidential information* (as defined in USPAP) to anyone other than the client and parties specifically authorized by the client (with the exception of those authorized by due process of law, state appraiser regulatory agencies, and a duly authorized professional peer review committee under certain conditions). Even if the lender who had contacted the appraiser was identified as an intended user in the original appraisal report, that lender is not part of the appraiser-client relationship. Therefore, authorization from the client would be needed if that lender wanted to discuss *assignment results* or *confidential information*.

Barring an agreement between the appraiser and the original client prohibiting disclosure of any information pertaining to the assignment, the appraiser may confirm that he or she performed an appraisal on the subject property, and may communicate anything other than *assignment results* (which include the appraiser's opinions and conclusions, in addition to the value conclusion) or *confidential information* (as defined in USPAP).

55. DISCLOSURE OF A PRIOR ASSIGNMENT

Question: As a condition of engagement, a financial institution requires that I disclose any prior appraisals I have completed on the subject property. If I disclose that I have previously appraised the subject property, am I violating USPAP?

Response: Disclosing the fact that you have previously appraised the property is permitted, **and required by USPAP as explained in the following paragraph**, except in the case when an appraiser has agreed to keep the mere occurrence of a prior assignment confidential.

The Conduct section of the ETHICS RULE states, in part:

If known prior to accepting an assignment, and/or if discovered at any time during the assignment, an appraiser must disclose to the client, and in the subsequent report certification:

- *any current or prospective interest in the subject property or parties involved; and*
- *any services regarding the subject property performed by the appraiser within the **three year period immediately preceding acceptance of the assignment**, as an appraiser or in any other capacity. (Bold added for emphasis)*

There are some cases in which the appraiser is asked by the client not to reveal that he or she has appraised that particular property. In such cases, the fact that the appraiser previously appraised the property is confidential information.

If the occurrence of a prior appraisal is confidential, and disclosure of prior appraisals is a condition of a potential new assignment or a requirement of USPAP, the appraiser must decline the new assignment because the appraiser could not make the requested disclosure.

56. DISCLOSURE OF THE CLIENT IN A PRIOR ASSIGNMENT

Question: **As a condition of engagement, I have been asked to disclose the name of the client for any prior appraisals I have completed on the subject property. Is making this disclosure a violation of USPAP?**

Response: A definitive answer cannot be provided. An appraiser must consider the circumstances when forming a response to a request to disclose the name of the client from a prior assignment.

The Confidentiality section of the ETHICS RULE states, in part:

An appraiser must protect the confidential nature of the appraiser-client relationship. There are some situations in which the appraiser cannot disclose the name of a prior client and still protect the confidential nature of the appraiser-client relationship:

A client may tell the appraiser to not disclose the fact that he or she appraised a particular property for that client. In that case, the name of the client becomes confidential information (as defined in USPAP) and it is clear that the appraiser cannot comply with the request for disclosure of the client's name.

There are other cases that simply require judgment on the part of the appraiser to determine whether disclosing the prior client's name would or would not *protect the confidential nature of the appraiser-client relationship*.

An appraiser who is asked to identify the client in a prior assignment may be able to protect the confidential nature of the appraiser-client relationship by identifying the client by type rather than name. Identifying the client by type describes the client with a generalization (for example: financial institution or accountant). However, there may be circumstances in which disclosing the identity of the client by type would actually disclose the name of the client (for example: property owner, trustee). In such a case, naming the client by type would not be a solution.

If disclosure of the client's identity is a condition of a potential new assignment, and the appraiser cannot disclose the client's identity and still protect the confidential nature of the appraiser-client relationship, then the appraiser must decline the new assignment.

57. CAN AN APPRAISER DISCLOSE THE IDENTITY OF PAST CLIENTS IN AN APPRAISAL REPORT?

Question: **I have a client that requires my résumé to be included with each appraisal report I perform for them. Does USPAP permit me to identify past clients in my résumé, since it will be included in the appraisal report?**

Response: There are no prohibitions in USPAP against identifying an appraiser's past clients. An exception might exist if the client told the appraiser not to disclose their identity.

58. SAMPLE APPRAISALS AND THE ETHICS RULE

Question: I am a fee appraiser currently seeking to get on the approved list for a local mortgage company. In order to be considered for approval, this lender requires appraisers to provide sample appraisal reports performed within the past year. Is there a way that I can accomplish this without violating USPAP?

Response: In order to provide this information an appraiser must satisfy the Confidentiality section of the ETHICS RULE. This section states:

An appraiser must protect the confidential nature of the appraiser-client relationship.

An appraiser must act in good faith with regard to the legitimate interests of the client in the use of confidential information and in the communication of assignment results.

An appraiser must be aware of, and comply with, all confidentiality and privacy laws and regulations applicable in an assignment.

An appraiser must not disclose: (1) confidential information or (2) assignment results to anyone other than:

- *the client;*
- *persons specifically authorized by the client;*
- *state appraiser regulatory agencies;*
- *third parties as may be authorized by due process of law; and*
- *a duly authorized professional peer review committee except when such disclosure to a committee would violate applicable law or regulation.*

The Comment further explains that if all essential elements of confidential information are removed through redaction or the process of aggregation, client authorization is not required for the disclosure of the remaining information, as modified.

The appraiser in this case has three options:

1. Decline the request to provide the information, or
2. Obtain authorization from the client of each sample appraisal report, or
3. Provide sample reports, but redact all information that should not be provided to anyone other than the client, such as confidential information or assignment results.

59. PROVIDING SAMPLE APPRAISAL REPORTS

Question: Recently I've heard that some appraisers are using a questionable technique to provide sample appraisal reports for prospective clients. These appraisers will redact all confidential information from the report (as required to comply with the Confidentiality section of the ETHICS RULE in USPAP) and send the redacted sample report to a prospective client, but then will follow-up with an additional e-mail that provides the client with all of the information that had been redacted from the sample report. Is this practice acceptable?

Response: No. Although the confidential information and assignment results are not being communicated simultaneously with the initial submission of the sample report, they are nonetheless being communicated in the subsequent e-mail transmission.

The Confidentiality section of the ETHICS RULE does not permit communicating confidential information and assignment results without the client’s consent, even if that information is provided in a separate communication.

60. CONFIDENTIALITY AND SAMPLE APPRAISAL REPORTS

Question: I have been looking for new clients and found that many request sample appraisals for review, but I’m concerned that I would be in violation of appraiser-client confidentiality by providing them. To alleviate this problem, I’m considering including the following disclaimer in the fine print of my reports:

“The appraiser reserves the right to utilize this report in its entirety as sample work for the purpose of soliciting prospective clients unless written refusal is received from the client.”

Does USPAP allow me to do this?

Response: No. The client, not the appraiser, determines who may receive the appraisal report. The Confidentiality section of the ETHICS RULE states, in part:

An appraiser must protect the confidential nature of the appraiser-client relationship.

An appraiser must act in good faith with regard to the legitimate interests of the client in the use of confidential information and in the communication of assignment results.

An appraiser must be aware of, and comply with, all confidentiality and privacy laws and regulations applicable in an assignment.

An appraiser must not disclose: (1) confidential information or (2) assignment results to anyone other than:

- the client;
- persons specifically authorized by the client;
- state appraiser regulatory agencies;
- third parties as may be authorized by due process of law; and
- a duly authorized professional peer review committee except when such disclosure to a committee would violate applicable law or regulation. (Bold added for emphasis.)

Including a statement indicating that the report may be used as a sample does not constitute client authorization to distribute copies of the report.

One solution is to obtain client authorization to use each report as a work sample. An alternative solution may be to redact all confidential information from the report before providing it as a sample. The Comment to the Rule states:

When all confidential elements of confidential information are removed through redaction or the process of aggregation, client authorization is not required for the disclosure of the remaining information, as modified.

61. DELIVERING A REPORT BY EMAIL TO A CLIENT

Question: I have been told that since email is not secure, delivering reports to my clients by email violates the confidentiality requirements of USPAP. Does emailing a report violate USPAP?

Response: No. It is the opinion of the Appraisal Standards Board that sending reports via email does not violate the confidentiality requirements in USPAP.

In all assignments the appraiser and the client should agree to a delivery method, and should understand any security risks associated with the delivery method. Whether a report is sent by government mail service, private mail service, email, courier or some other mechanism, there is always some risk that the security of the original document may be compromised.

62. CONFIDENTIALITY AND INTENDED USERS

Question: I recently performed an appraisal. Yesterday, an intended user who is not the client contacted me to discuss the appraisal. Do I need the client's authorization to discuss the appraisal with this intended user?

Response: Yes. Although intended users have an important role in the appraiser's decisions about the appropriate scope of work and the content of the report, the appraiser cannot discuss the appraisal with an intended user without the client's authorization. The Confidentiality section of the ETHICS RULE states:

An appraiser must not disclose: (1) confidential information; or (2) assignment results to anyone other than:

- *the client;*
- *persons specifically authorized by the client...* (Bold added for emphasis)

The appraiser-client relationship is distinct from the appraiser's relationship to intended users.

63. CONFIDENTIALITY AND REVIEW APPRAISERS

Question: A few weeks ago I performed an appraisal for a lender client. I was recently contacted by an individual who claims that she is a review appraiser that has been hired by the lender, and wanted to ask me some questions about my appraisal. Can I discuss my appraisal with her?

Response: Yes; but *only* if you receive authorization from the client. The Confidentiality section of the ETHICS RULE states, in part:

An appraiser must protect the confidential nature of the appraiser-client relationship.

An appraiser must not disclose: (1) confidential information; or (2) assignment results to anyone other than:

- *the client;*
- *persons specifically authorized by the client;*

- *state appraiser regulatory agencies;*
- *third parties as may be authorized by due process of law; and*
- *a duly authorized professional peer review committee except when such disclosure to a committee would violate applicable law or regulation.*

64. DISCLOSURE OF ASSIGNMENT RESULTS TO STATE APPRAISER REGULATORY AGENCY

Question: A new state law requires all real estate appraisers in my area to regularly submit a log to the State Appraiser Board reporting the address of properties appraised along with the value opinion. Does this violate the confidentiality requirements in USPAP?

Response: No. This does not violate USPAP.

The Confidentiality section of the ETHICS RULE states, in part:

An appraiser must not disclose: (1) confidential information or (2) assignment results to anyone other than:

- *the client;*
- *persons specifically authorized by the client;*
- ***state appraiser regulatory agencies;***
- *third parties as may be authorized by due process of law; and*
- *a duly authorized professional peer review committee except when such disclosure to a committee would violate applicable law or regulation. (Bold added for emphasis.)*

Disclosure of assignment results to the state board, or to any other entity required by law, is specifically permitted.

65. DUE PROCESS UNDER CONFIDENTIALITY

Question: I received a request from my state attorney general's office to turn over some appraisal reports I had prepared. Can I comply with this simple request or must it be in the form of a subpoena?

Response: The Confidentiality section of the ETHICS RULE states, in part:

An appraiser must not disclose: (1) confidential information or (2) assignment results to anyone other than:

- *the client;*
- *persons specifically authorized by the client;*
- ***state appraiser regulatory agencies;***
- *third parties as may be authorized by due process of law; and*
- *a duly authorized professional peer review committee except when such disclosure to a committee would violate applicable law or regulation. (Bold added for emphasis.)*

USPAP does not identify what constitutes due process of law. While a subpoena or court order might clearly constitute due process, a simple verbal or written request might not. Therefore, for requests of this type, it may be necessary to seek legal counsel to determine what constitutes due process.

66. COMMUNICATING CONFIDENTIAL INFORMATION TO A SWORN PEACE OFFICER

Question: I was contacted by a sworn peace officer who simply requested the workfile of an assignment I had previously completed. The officer made this request without a subpoena or any form of court order. If the workfile contains confidential information, does USPAP allow me to comply with the officer's request?

Response: The answer to the question depends on whether or not the officer's request qualifies as due process of law.

The Confidentiality section of the ETHICS RULE states, in part:

An appraiser must not disclose: (1) confidential information or (2) assignment results to anyone other than:

- the client;
- persons specifically authorized by the client;
- state appraiser regulatory agencies;
- third parties as may be authorized by due process of law; and
- a duly authorized professional peer review committee except when such disclosure to a committee would violate applicable law or regulation.

It is likely that this determination would need to be made by a court or other legal body, since USPAP does not define what due process of law constitutes. You may want to seek legal advice to determine an appropriate response.

It is also important to note that if the officer made the request on behalf of a state enforcement agency, the portion of the Confidentiality section of the ETHICS RULE quoted above allows the appraiser to communicate confidential information.

67. CONFIDENTIALITY AND PEER REVIEW COMMITTEES

Question: Is it ethical to disclose confidential information to a duly authorized professional peer review committee?

Response: Yes. However, the appraiser must be aware of and comply with applicable laws or regulations that would pertain to such disclosure. The Confidentiality section of the ETHICS RULE states, in part:

An appraiser must protect the confidential nature of the appraiser-client relationship.

An appraiser must act in good faith with regard to the legitimate interests of the client in the use of confidential information and in the communication of assignment results.

An appraiser must be aware of, and comply with, all confidentiality and privacy laws and regulations applicable in an assignment.

An appraiser must not disclose: (1) confidential information or (2) assignment results to anyone other than:

- the client;
- persons specifically authorized by the client;
- state appraiser regulatory agencies;

- *third parties as may be authorized by due process of law; and*
- ***a duly authorized professional peer review committee except when such disclosure to a committee would violate applicable law or regulation.*** (Bold added for emphasis.)

Comment: When all confidential elements of confidential information are removed through redaction or the process of aggregation, client authorization is not required for the disclosure of the remaining information, as modified.

68. CONFIDENTIALITY AND PRIVACY REGULATIONS

Question: Does USPAP address the federal privacy laws? And, if it does, where does it address them?

Response: Yes. Due to federal regulatory activity, most notably the Federal Trade Commission’s Final Rule on Privacy of Consumer Financial Information, 16 CFR Part 313, that took effect on July 1, 2001, the ASB edited USPAP to incorporate these laws.

1. The Confidentiality section of the ETHICS RULE illustrates that, *an appraiser must be aware of, and comply with, all confidentiality and privacy laws and regulations applicable in an assignment.*

A footnote regarding the adoption of federal privacy regulations is also included in this section.

2. The definition of confidential information reads:

information that is either:

- *identified by the client as confidential when providing it to an appraiser and that is not available from any other source; or*
- *classified as confidential or private by applicable law or regulation.*

A note regarding the adoption of federal privacy regulations is also included in this definition.

69. WHEN DOES APPRAISER-CLIENT CONFIDENTIALITY END?

Question: I performed an appraisal assignment for a lender client who has subsequently gone out of business. Now the borrower is requesting a copy of the appraisal report from me since the company is defunct and there is no way to contact them. Does my obligation for appraiser-client confidentiality end since the client no longer exists?

Response: No. USPAP has no provision for terminating appraiser-client confidentiality. An appraiser is required to comply with the requirements of the Confidentiality section of the ETHICS RULE, regardless of the status of the client.

70. COPYRIGHTING AN APPRAISAL REPORT

Question: Does registration of a copyright on an appraisal report with the U.S. Copyright Office violate the confidentiality provisions of USPAP?

Response: The ASB is taking no position as to whether an appraisal report is copyrightable, nor does this response constitute a legal opinion of the ASB.

If, however, an appraisal report is copyrightable, and if the process of registration with the U.S. Copyright Office includes public disclosure of the appraisal report, such registration would disclose assignment results and, therefore, result in a breach of the Confidentiality section of the ETHICS RULE of USPAP, unless the appraiser/registrant had the prior approval of the client for such registration.

71. SELLING AN APPRAISAL FIRM AND ETHICAL OBLIGATIONS

Question: I am considering the sale of my appraisal practice. What are my USPAP obligations regarding confidentiality and record keeping?

Response: In the sale of an appraisal practice, the selling appraiser must comply with the Confidentiality section of the ETHICS RULE and the RECORD KEEPING RULE.

The Confidentiality section of the ETHICS RULE states:

An appraiser must protect the confidential nature of the appraiser-client relationship

An appraiser must act in good faith with regard to the legitimate interests of the client in the use of confidential information and in the communication of assignment results.

An appraiser must be aware of, and comply with, all confidentiality and privacy laws and regulations applicable in an assignment.

The RECORD KEEPING RULE states:

An appraiser must have custody of the workfile, or make appropriate workfile retention, access, and retrieval arrangements with the party having custody of the workfile.

The selling appraiser can retain possession of the workfiles to satisfy confidentiality and record keeping obligations. This would also satisfy any client confidentiality agreements and applicable privacy laws and regulations.

The selling appraiser must adhere to the requirement to (1) protect the appraiser-client relationship and (2) not disclose assignment results and confidential information to anyone other than the client and persons specifically authorized by the client. This can be accomplished by seeking client authorization to disclose assignment results and confidential information that would be part of the workfile. Providing the acquiring appraiser with access to the selling appraiser's workfiles without client authorization is a violation of the Confidentiality section of the ETHICS RULE.

With client authorization, the selling appraiser can provide the acquiring appraiser with access to the selling appraiser's workfiles. However, the selling appraiser should also consider the impact of applicable privacy laws and regulations.

To comply with the RECORD KEEPING RULE, the selling appraiser should make appropriate workfile retention, access, and retrieval arrangements as part of the sale terms.

72. PURCHASING AN APPRAISAL FIRM AND ETHICAL OBLIGATIONS

Question: I am considering the purchase of another appraiser’s appraisal practice. What are my USPAP obligations regarding record keeping and confidentiality?

Response: The acquiring appraiser has general USPAP obligations to protect public trust in appraisal practice. The PREAMBLE states:

The appraiser’s responsibility is to protect the overall public trust and it is the importance of the role of the appraiser that places ethical obligations on those who serve in this capacity.

The ETHICS RULE states:

An appraiser must promote and preserve the public trust inherent in professional appraisal practice, observing the highest standards of professional ethics.

In the sale of an appraisal practice, the acquiring appraiser should respect the selling appraiser’s obligations under the Confidentiality section of the ETHICS RULE and the RECORD KEEPING RULE.

The acquiring appraiser does not have an appraiser-client relationship with the clients of the selling appraiser, but the acquiring appraiser’s obligation to protect public trust creates a responsibility when access is provided to another appraiser’s workfile. The acquiring appraiser should treat the acquired assignment results and confidential information in the workfiles in compliance with USPAP.

The acquiring appraiser should honor the workfile retention, access, and retrieval arrangements made by the selling appraiser in compliance with the following RECORD KEEPING RULE.

An appraiser having custody of a workfile must allow other appraisers with workfile obligations related to an assignment appropriate access and retrieval for the purpose of:

- *submission to state appraiser regulatory agencies;*
- *compliance with due process of law;*
- *submission to a duly authorized professional peer review committee; or*
- *compliance with retrieval arrangements.*

RECORD KEEPING RULE

73. CONTENTS OF A WORKFILE

Question: What information must be retained in an appraiser's workfile?

Response: An appraiser must prepare a workfile for each appraisal, appraisal review, or appraisal consulting assignment. The RECORD KEEPING RULE states:

The workfile must include:

- *the name of the client and the identity, by name or type, of any other intended users;*
- *true copies of any written reports, documented on any type of media (A true copy is a replica of the report transmitted to the client. A photocopy or an electronic copy of the entire report transmitted to the client satisfies the requirement of a true copy.);*
- *summaries of all oral reports or testimony, or a transcript of testimony, including the appraiser's signed and dated certification;*
- *all other data, information, and documentation necessary to support the appraiser's opinions and conclusions and to show compliance with USPAP, or references to the location(s) of such other documentation; and*
- *a workfile in support of a Restricted Use Appraisal Report must be sufficient for the appraiser to produce a Summary Appraisal Report (for assignments communicated under STANDARDS 2 and 8) or an Appraisal Report (for assignments communicated under STANDARD 10).*

The appraiser's assignment workfile serves several purposes. As in many other professions, the discipline of enforcement by public agencies and peer review, together with one's self-discipline and dedication of effort, serves to ensure performance of assignments in compliance with professional standards. In addition to facilitating enforcement, a workfile aids the appraiser in handling questions from the client or an intended user subsequent to the date of the report.

An appraiser's assignment workfile preserves evidence of the appraiser's compliance with USPAP and other information as may be required to support the appraiser's opinions, conclusions, and, in the case of an appraisal consulting assignment, recommendations.

74. TIME PERIOD TO RETAIN WORKFILES

Question: How long do I have to retain a workfile for an assignment?

Response: The RECORD KEEPING RULE states:

An appraiser must retain the workfile for a period of at least five (5) years after preparation or at least two (2) years after final disposition of any judicial proceeding in which the appraiser provided testimony related to the assignment, whichever period expires last.

75. **DISPOSAL OF WORKFILES (NEW)**

Question: I am aware of and comply with the workfile retention requirements in the RECORD KEEPING RULE in USPAP. However, once the required retention period has passed, does USPAP dictate a method I must employ to dispose of the workfiles?

Response: No, USPAP does not dictate a particular method for disposal of workfiles. However, because there are no provisions in USPAP for termination of the appraiser-client relationship and the appraiser's respective confidentiality obligations, appraisers must ensure that they do not violate the Confidentiality section of the ETHICS RULE even when disposing of workfiles.

This means that appraisers must ensure that whatever method they employ to dispose of workfiles does not allow for the communication of *assignment results* or *confidential information* (both, as defined in USPAP) in the disposal process.

76. **PHOTOCOPIES OF APPRAISAL REPORTS IN WORKFILES**

Question: In order to satisfy the RECORD KEEPING RULE, must an appraiser retain a complete photocopy of the finished appraisal report that was sent to the client?

Response: The workfile must contain a true copy of the report. A photocopy or an electronic copy of the entire appraisal report transmitted to the client satisfies the USPAP requirement of a true copy.

77. **WORKFILES FOR APPRAISAL REVIEW ASSIGNMENTS**

Question: I am a manager for an Appraisal Management Company that performs commercial and residential appraisals in various parts of the country. Our company acts as the agent for our clients who consist of numerous regional and national lenders. In that capacity, we take in appraisal orders from our clients and order those appraisals from fee appraisers on our approved list of appraisers. We also perform STANDARD 3 compliant reviews on those appraisals. We forward the appraisal and appraisal review reports to our client. Are we required to keep a file of the appraisal reviews?

Response: Yes. The RECORD KEEPING RULE requires, in part:

*An appraiser must prepare a workfile for each appraisal, **appraisal review**, or appraisal consulting assignment.*

The workfile must include:

- *the name of the client and the identity, by name or type, of any other intended users;*
- ***true copies of any written reports** documented on any type of media (A true copy is a replica of the report transmitted to the client. A photocopy or an electronic copy of the entire report transmitted to the client satisfies the requirement of a true copy.);*
- *summaries of all oral reports or testimony or a transcript of testimony, including the appraiser's signed and dated certification;*
- *all other data, information, and documentation necessary to support the appraiser's opinions and conclusions and to show compliance with USPAP, or references to the location(s) of such other documentation; and*

- *a workfile in support of a Restricted Use Appraisal Report must be sufficient for the appraiser to produce a Summary Appraisal Report (for assignments communicated under STANDARDS 2 and 8) or an Appraisal Report (for assignments communicated under STANDARD 10). (Bold added for emphasis.)*

Further, it is important to note that the requirement under USPAP is for the appraiser to retain a copy of:

the workfile for a period of at least five (5) years after preparation or at least two (2) years after final disposition of any judicial proceeding in which the appraiser provided testimony related to the assignment, whichever period expires last.

Therefore, it is incumbent upon the appraiser, not his or her employer, to ensure that a copy of the workfile is available for the time periods stipulated.

78. PURGING WORKFILES AT A CLIENT’S REQUEST

Question: **If requested by a client, can I purge my appraisal files and records of an appraisal that was not utilized in loan underwriting or in any other manner by the client?**

Response: No. USPAP does not permit appraisers to destroy records prior to five years after preparation **for any reason**, including a client’s request to do so or the fact that an appraisal is not utilized by the client. The RECORD KEEPING RULE states, in part:

An appraiser must prepare a workfile for each appraisal, appraisal review, or appraisal consulting assignment.

An appraiser must retain the workfile for a period of at least five (5) years after preparation or at least two (2) years after final disposition of any judicial proceeding in which the appraiser provided testimony related to the assignment, whichever period expires last.

In addition, the Conduct section of the ETHICS RULE states, in part, that an appraiser:

must not willfully or knowingly violate the requirements of the RECORD KEEPING RULE.

79. WORKFILE RETENTION WITH MORE THAN ONE APPRAISER

Question: **If two appraisers sign an appraisal report, what are the obligations related to record keeping? Specifically, must both appraisers keep a copy of the workfile?**

Response: No. It is not necessary for both appraisers to have a copy of the workfile.

The RECORD KEEPING RULE states, in part:

An appraiser must have custody of the workfile, or make appropriate workfile retention, access, and retrieval arrangements with the party having custody of the workfile.

Neither appraiser is required to have custody of the workfile. However, an appraiser who does not have custody must make appropriate arrangements for retention, access, and retrieval.

See Advisory Opinion 31, *Assignments Involving More than One Appraiser* for further guidance.

80. RESPONSIBILITY FOR WORKFILE RETENTION

Question: (1.) **Jim, an independent contractor, works for my appraisal company on a regular basis. I have always kept all appraisal file documentation (including hard copies of appraisal reports, field notes, drawings, photographs, and data) at my office. Now Jim wants to keep the files relating to his work in his own possession. Under USPAP, which appraiser should keep the workfile?**

Question: (2.) **Is the RECORD KEEPING RULE upheld if an institutionally employed appraiser ensures that his organization retains copies of his appraisal work for five years? Or, must the appraiser also maintain a personal file of all work performed?**

Question: (3.) **A client's attorney requested that I supply all of my files/records regarding an assignment. Can I do this and still be in compliance with the record keeping requirements for USPAP? Also, what must I retain in my files as proof that the files are now the responsibility of the attorney? Will a simple letter from the client be sufficient?**

Response: In responding to each of the three preceding questions, what should be considered is that, according to USPAP, **the appraiser**, not the appraiser's employer or client, is ultimately responsible for the retention of the workfile for the prescribed period. (Bold added for emphasis) (See RECORD KEEPING RULE)

When workfiles will be retained by an employer, client, co-appraiser or any other party, the appraiser must make arrangements with that party to protect and preserve the workfile, and to allow the appraiser to make the workfile available to other parties such as state appraiser regulatory agencies, professional peer review committee, or when required by due process of law.

There are a number of ways an appraiser who works for or with another party can ensure that files are retained so that the appraiser can have access to the files to meet the requirements of the RECORD KEEPING RULE. For example, an appraiser and his employer or colleague may agree that the files will remain in the employer's or colleague's custody for the duration of the requisite retention period and that the appraiser will have access to those files, if needed.

USPAP does not dictate the form or format of workfile documentation. It is not necessary to include original documents in the file; photocopies and electronic copies are acceptable as true copies. Because there have been cases where employers and others have denied appraisers access to workfiles, an appraiser may wish to make and retain copies of workfiles. However, USPAP does not address any specific manner by which an employer or contractor and appraiser should handle record retention. This is a business matter which should be arranged in the context of the employer- or contractor-appraiser relationship.

By the same token, providing the workfile to a duly authorized party, such as a client's attorney, is permitted by USPAP. However, this does not relieve the appraiser of the responsibility for that workfile. At no time may an appraiser abdicate his or her responsibility for a workfile. Therefore, when an appraiser relinquishes possession of a file to a client or the client's representative, the appraiser should retain either a copy of the workfile or a written reference to an agreement with the client that the appraiser will have access to the workfile, if the need arises.

81. TRAINEE ACCESS TO WORKFILES

Question: I am a trainee appraiser and have been working with the same supervising appraiser for some time. Recently, my supervising appraiser told me that since I was only a trainee, I had no right to access workfiles on appraisals where I provided significant professional assistance. Is my supervising appraiser correct? Do trainees have no rights regarding access to workfiles?

Response: As background, USPAP places workfile retention requirements on the appraiser. In assignments where more than one appraiser is involved (e.g. a trainee appraiser and a supervising appraiser) each appraiser shares responsibility for complying with the RECORD KEEPING RULE.

Supervising appraisers should be aware that all appraisers, including trainee appraisers, must maintain access to workfiles for a minimum of five years. A supervising appraiser must not impede a trainee appraiser's ability to access workfiles. Denying access to workfiles is a violation of the RECORD KEEPING RULE.

An appraiser having custody of a workfile must allow other appraisers with workfile obligations related to an assignment appropriate access and retrieval for the purpose of:

- *submission to state appraiser regulatory agencies;*
- *compliance with due process of law;*
- *submission to a duly authorized professional peer review committee; or*
- *compliance with retrieval arrangements.*

An appraiser who willfully or knowingly fails to comply with the obligations of this RECORD KEEPING RULE is in violation of the ETHICS RULE.

See Advisory Opinion 31, *Assignments Involving More than One Appraiser*, for further guidance.

82. APPROPRIATE WORKFILE RETENTION AND ACCESS ARRANGEMENTS

Question: USPAP requires an appraiser who is not in custody of his or her workfile to make appropriate retention and access arrangements; what does this mean?

Response: The RECORD KEEPING RULE states, in part:

*An appraiser must have custody of the workfile, or **make appropriate workfile retention, access, and retrieval arrangements with the party having custody of the workfile.*** (Bold added for emphasis)

There are a number of ways an appraiser who works for or with another party can ensure that the assignment workfile is retained so that the appraiser may access the workfile. The following is a common example: an appraiser and his employer or colleague agrees that the workfile will remain in the employer's or colleague's custody for the duration of the requisite retention period and that the appraiser will have access to the workfile. In practice, having such an agreement in writing could prove beneficial to all parties if access and retrieval arrangements are subsequently called into question.

83. MAY ACCESS TO A WORKFILE BE DENIED?

Question: Two appraisers perform an appraisal assignment together. Appraiser A retains the workfile and Appraiser B has made access and retrieval arrangements. Are there any conditions under which USPAP allows Appraiser A to deny Appraiser B access to the workfile?

Response: Yes. USPAP does not set conditions for workfile access and retrieval. However, the RECORD KEEPING RULE states:

*An appraiser having custody of a workfile **must allow other appraisers with workfile obligations** related to an assignment appropriate access and retrieval for the purpose of:*

- *submission to state appraiser regulatory agencies;*
- *compliance with due process of law;*
- *submission to a duly authorized professional peer review committee; or*
- *compliance with retrieval arrangements. (Bold added for emphasis.)*

In this scenario, if Appraiser B is seeking access for purposes outside those specified, access may be denied.

84. ACCESS AND RETRIEVAL OF WORKFILES (NEW)

Question: I am an appraiser in a large firm and assist several of the senior appraisers in appraisal research, analysis and report preparation. In a recent USPAP class, the instructor said that associates must have either copies of their workfiles, or an agreement with their employer regarding access to the workfiles, for appraisals on which they provided significant assistance. Does that agreement have to be in writing?

Response: No. USPAP does not specify whether the access and retrieval arrangements you make must be in writing. The RECORD KEEPING RULE states:

An appraiser must have custody of the workfile, or make appropriate workfile retention, access, and retrieval arrangements with the party having custody of the workfile.

This agreement can be either written or oral. However, there is less chance for a misunderstanding about the agreement if it is in writing.

85. SIGNED CERTIFICATION IN TRUE COPIES

Question: The RECORD KEEPING RULE states, in part:

The workfile must include...true copies of any written reports...

Does a true copy have to include a signature on the certification?

Response: Yes. A true copy is a replica of the report sent to the client. Any signatures that were affixed to the original report must also exist on the copy for the workfile.

86. CREATING A WORKFILE AFTER REPORT DELIVERY

Question: I was recently told that USPAP allows appraisers to wait and create a workfile after the report has been delivered to the client for an appraisal, appraisal review, or appraisal consulting assignment. Is this true?

Response: No. The RECORD KEEPING RULE states:

*A workfile must be in existence **prior to the issuance of any report**. A written summary of an oral report must be added to the workfile within a reasonable time after the issuance of the oral report. (Bold added for emphasis)*

It is advisable to create a workfile as soon as an agreement between an appraiser and a client results in an assignment.

87. IS A TRANSCRIPT REQUIRED FOR ORAL REPORT AND TESTIMONY?

Question: Is a transcript of an oral report or testimony required for the workfile when an appraiser testifies about an appraisal assignment?

Response: No. There is no absolute requirement to have a transcript of the appraisal oral report testimony. The RECORD KEEPING RULE requirement is for the workfile to contain summaries (which are typically prepared by the appraiser) or a transcript. In cases where summaries are retained, a transcript is not required.

88. IS A TRANSCRIPT REQUIRED IF A WRITTEN APPRAISAL REPORT WAS PREPARED?

Question: Does the requirement to have a transcript or summary of testimony apply if the appraiser has a written appraisal report and testifies only to the information contained in that report?

Response: Yes. A transcript or summary of the testimony must be included in the workfile when the appraiser testifies about a written report. While the report that is the subject of the appraiser's testimony must also be included in the assignment workfile, it does not replace a summary of the testimony.

89. RECORD KEEPING REQUIREMENTS FOR ORAL REPORTS AND TESTIMONY

Question: Does the requirement to have a transcript or a summary of the appraiser's testimony apply only in assignments when an appraiser provides an oral report?

Response: No. The requirements identified in the RECORD KEEPING RULE apply to both oral reports and testimony in an appraisal, appraisal review, or appraisal consulting assignment.

90. IS A SEPARATE CERTIFICATION REQUIRED IF A WRITTEN APPRAISAL REPORT WAS PREPARED?

Question: If an appraiser prepares a written appraisal report, is the workfile required to contain a separate signed certification for any testimony the appraiser provided in support of that report?

Response: In cases where testimony is provided about information contained in a written appraisal report, appraisal review, or appraisal consulting report, a signed certification is required to be included in the written report. The requirement to include a signed certification is satisfied by including a true copy of the report in the workfile, consistent with the RECORD KEEPING RULE.

91. IS A TRANSCRIPT OF THE ENTIRE PROCEEDING REQUIRED?

Question: Must the workfile contain a transcript or summary of an appraiser's testimony for the entire proceeding, or only for that portion that contains the appraiser's testimony?

Response: The appraiser's workfile must contain a summary or a transcript of the appraiser's testimony in an appraisal, appraisal review, or appraisal consulting assignment. The appraiser is not obligated to retain summaries or transcripts for other segments of the proceedings in which testimony was provided by individuals other than the appraiser.

92. ELECTRONIC WORKFILE STORAGE

Question: Recently I have considered maintaining only electronic workfiles (i.e., saving only electronic versions of my reports and supporting data, and scanning any paper documents used so that copies may be stored on electronic media). Is this prohibited by USPAP?

Response: No. There is nothing in USPAP that would prohibit an appraiser from maintaining only electronic versions of workfiles.

The RECORD KEEPING RULE states, in part:

An appraiser must prepare a workfile for each appraisal, appraisal review, or appraisal consulting assignment.

The workfile must include:

- *the name of the client and the identity, by name or type, of any other intended users;*
- *true copies of any written reports documented on any type of media (A true copy is a replica of the report transmitted to the client. A photocopy or an electronic copy of the entire report transmitted to the client satisfies the requirement of a true copy.);*
- *summaries of all oral reports or testimony, or a transcript of testimony, including the appraiser's signed and dated certification;*
- *all other data, information, and documentation necessary to support the appraiser's opinions and conclusions and to show compliance with USPAP, or references to the location(s) of such other documentation; and*
- *a workfile in support of a Restricted Use Appraisal Report must be sufficient for the appraiser to produce a Summary Appraisal Report (for assignments communicated*

under STANDARDS 2 and 8) or an Appraisal Report (for assignments communicated under STANDARD 10). (Bold added for emphasis.)

As long as an electronic workfile contained these items, it would be sufficient.

Care should be exercised in the selection of the form, style, and type of medium for records to ensure that they are retrievable by the appraiser throughout the prescribed record retention period. The appraiser must ensure that the proper software is maintained to allow access to the electronic files

93. PAPER COPIES OF ELECTRONICALLY TRANSMITTED REPORTS

Question: Are appraisers required by USPAP to retain a paper copy of electronically transmitted appraisal reports?

Response: No. The RECORD KEEPING RULE requires appraisers to prepare and retain written records of appraisal, appraisal review, and appraisal consulting assignments.

A photocopy or an electronic copy of the entire report transmitted to the client satisfies the requirement of a true copy.

Therefore, a paper copy is not required.

94. ADEQUACY OF WORKFILE DOCUMENTATION

Question: In the course of preparing my appraisals, I often research Multiple Listing Service (MLS) and other data sources. I use this information to develop conclusions regarding neighborhood value ranges and market trends. Is it necessary for me to include copies of this information in my workfile? Alternatively, can I simply reference the data sources in my workfile?

Response: References in the workfile to the location of documentation used to support an appraiser's analyses, opinions, and conclusions can be adequate. It is not always necessary for the appraisal workfile to include all the documentation provided the referenced material is retrievable by the appraiser throughout the workfile retention period. Care should be exercised in the selection of the format and location of documentation.

The RECORD KEEPING RULE states that the workfile must include:

all other data, information, and documentation necessary to support the appraiser's opinions and conclusions and to show compliance with USPAP, or references to the location(s) of such other documentation. (Bold added for emphasis.)

95. JURISDICTIONAL EXCEPTION AND WORKFILE RETENTION

Question: My state law requires an appraiser to retain workfiles for three years after the valuation date. Is this an example of a jurisdictional exception?

Response: No. The JURISDICTIONAL EXCEPTION RULE states

If any applicable law or regulation precludes compliance with any part of USPAP, only that part of USPAP becomes void for that assignment.

In the scenario described in question, complying with the RECORD KEEPING RULE would exceed the requirements of the law, but it would not be precluded by the law.

By retaining access to workfiles for the longer period required by USPAP, the appraiser would also be in compliance with the law. Therefore, this would not be a jurisdictional exception.

96. MINIMUM WORKFILE RETENTION

Question: My state appraisal board is asking me to send a copy of the workfile for an appraisal I performed eight years ago. Since I provided no testimony in the assignment, I was only required to maintain access to the workfile for five years. Given that this time period has expired, can the state board still take action in this case?

Response: Yes. The time frames referenced in the RECORD KEEPING RULE are only minimums. Nothing in USPAP would prevent an enforcement proceeding from taking place after the applicable time period had expired.

COMPETENCY RULE

97. ACQUIRING KNOWLEDGE AND EXPERIENCE TO COMPLY WITH THE COMPETENCY RULE

Question: How does an appraiser gain the knowledge and experience required by the COMPETENCY RULE if he or she lacks the knowledge and experience to complete an assignment competently?

Response: The COMPETENCY RULE requires an appraiser who lacks the knowledge and experience to complete an assignment competently to [a.] disclose the lack of knowledge and/or experience to the client before accepting the assignment, or [b.] disclose the lack of knowledge and/or experience to the client during the assignment if discovered by the appraiser during the assignment. In either instance, the appraiser must then take all steps necessary to appropriately complete the assignment competently and document the steps in the appraisal report. An appraiser may gain the knowledge and experience required through any or all of the following: personal study by the appraiser; association with an appraiser reasonably believed to have the necessary knowledge or experience; or, retention of others who possess the required knowledge or experience.

In addition, the COMPETENCY RULE also requires that an appraiser in an assignment must withdraw from the assignment if competency cannot be achieved prior to completion of the assignment.

Refer to the COMPETENCY RULE for further guidance.

98. ASSIGNMENT CONDITIONS, SCOPE OF WORK ACCEPTABILITY, AND GEOGRAPHIC COMPETENCY (NEW)

Question: I am a residential appraiser performing work for several Appraisal Management Companies. Often, I am asked to perform an appraisal assignment outside the areas I am most familiar with. The assignments come with a requirement that a completed report be submitted within 48 hours or less. This time frame does not permit me to adequately research the subject property market. Is it permissible for me to accept an assignment under these conditions?

Response: The COMPETENCY RULE in USPAP requires an appraiser to notify the client that he or she does not have the necessary competency to complete an assignment prior to accepting the assignment. Because your statement in the question states that the “time frame does not permit me to adequately research the subject property market,” you have already made the determination that becoming geographically competent for this assignment is a concern. The client must be notified, appropriate steps must be taken to become competent, and the lack of competency, plus the steps taken to become competent, must be disclosed in the assignment report. If an appraiser is not in a position to spend the necessary time in a market area to attain geographic competency, affiliation with a qualified local appraiser may be an appropriate response to ensure development of credible assignment results. Alternatively, the appraiser must decline the assignment.

This situation is also addressed by the SCOPE OF WORK RULE in USPAP:

For each appraisal, appraisal review, and appraisal consulting assignment, an appraiser must:

1. *identify the problem to be solved;*
2. ***determine and perform the scope of work necessary to develop credible assignment results; and***
3. *disclose the scope of work in the report. (Bold added for emphasis)*

Scope of work is defined as the type and extent of research and analyses in an assignment. If you know that the required time frame does not permit you to adequately research the subject property market in order to complete the scope of work necessary to develop credible assignment results, you should decline the assignment.

In some situations, you may initially believe that you can complete the scope of work necessary to develop credible assignment results, but subsequently determine you are unable to do so and still comply with the specific time frame. This circumstance is specifically covered in the Scope of Work Acceptability section of the SCOPE OF WORK RULE.

An appraiser must not allow assignment conditions to limit the scope of work to such a degree that the assignment results are not credible in the context of the intended use.

Comment: If relevant information is not available because of assignment conditions that limit research opportunities (such as conditions that place limitations on inspection or information gathering), an appraiser must withdraw from the assignment unless the appraiser can:

- *modify the assignment conditions to expand the scope of work to include gathering the information; or*
- *use an extraordinary assumption about such information, if credible assignment results can still be developed.*

99. CONTINUING EDUCATION COURSES

Question: Does USPAP require appraisers to take continuing education courses?

Response: Not directly; however, Standards Rule 1-1(a), states the following.

In developing a real property appraisal, an appraiser must:

- (a) *be aware of, understand, and correctly employ those recognized methods and techniques that are necessary to produce a credible appraisal;*

*Comment: This Standards Rule recognizes that the principle of change continues to affect the manner in which appraisers perform appraisal services. Changes and developments in the real estate field have a substantial impact on the appraisal profession. Important changes in the cost and manner of constructing and marketing commercial, industrial, and residential real estate as well as changes in the legal framework in which real property rights and interests are created, conveyed, and mortgaged have resulted in corresponding changes in appraisal theory and practice. Social change has also had an effect on appraisal theory and practice. To keep abreast of these changes and developments, the appraisal profession is constantly reviewing and revising appraisal methods and techniques and devising new methods and techniques to meet new circumstances. **For this reason, it is not sufficient for appraisers to simply maintain the skills and the knowledge they possess when they become appraisers. Each appraiser must continuously improve his or her skills to remain proficient in real property appraisal.** (Bold added for emphasis)*

The last sentence of the Comment to SR 1-1(a) clearly indicates that appraisers must continuously improve their knowledge and skills. Therefore, some form of continuing education is required, although not explicitly stated in the USPAP document.

100. COMPETENCY STATEMENT IN THE REPORT

Question: Does USPAP require an appraiser to include a competency statement in all reports?

Response: No. USPAP does not require that an appraiser provide a statement of competency in all reports. Only when the appraiser accepts an assignment with a lack of knowledge and/or experience does the COMPETENCY RULE require the appraiser to describe the lack of knowledge and/or experience and the steps taken to complete the assignment competently in the report.

101. ERRORS AND OMISSIONS INSURANCE

Question: Does USPAP require appraisers to be covered by errors and omissions (E&O) insurance?

Response: USPAP does not address E&O insurance. However, if an appraiser is required to have E&O insurance as a matter of law or regulation, he or she must comply with that requirement under the COMPETENCY RULE which requires recognition of, and compliance with, laws and regulations that apply to the appraiser or the assignment.

JURISDICTIONAL EXCEPTION RULE

102. APPLICATION OF THE JURISDICTIONAL EXCEPTION RULE

Question: When does the JURISDICTIONAL EXCEPTION RULE apply in an assignment?

Response: The JURISDICTIONAL EXCEPTION RULE exempts appraisers from the part or parts of USPAP that are precluded by law or regulation. The Rule applies anytime there is a conflict between the requirements of USPAP and the applicable law or regulation of a jurisdiction.

An appraiser using the JURISDICTIONAL EXCEPTION RULE must properly identify and comply with the law or regulation that precludes compliance with USPAP. In addition, the appraiser must disclose in the report the part of USPAP that is voided by that law and regulation, and also cite in the report the specific law or regulation that precludes compliance with USPAP.

The Comment to the JURISDICTIONAL EXCEPTION RULE includes language that helps appraisers recognize laws and regulations. However, in every case, it is ultimately the responsibility of the appraiser, and not the client or other intended users, to determine whether the use of the JURISDICTIONAL EXCEPTION RULE is appropriate.

103. USPAP COMPLIANCE AND JURISDICTIONAL EXCEPTION

Question: I am a real property appraiser and a government employee. The agency I work for wants me to provide a preliminary estimate of value. The agency policy states that this work is not an appraisal and is not covered by USPAP because of a jurisdictional exception. Should I comply with USPAP when I prepare a preliminary estimate of value?

Response: This question raises a number of issues related to USPAP compliance and the application of the JURISDICTIONAL EXCEPTION RULE.

Based on your identification as an appraiser, you should comply with USPAP. This is because an individual's public identification as an appraiser establishes an expectation that valuation services will be performed in compliance with USPAP. You must comply with USPAP when required by law, regulation, or agreement. Even if the agency policy does not require USPAP compliance, other applicable law or regulation might require compliance.

The JURISDICTIONAL EXCEPTION RULE cannot be used to resolve this type of USPAP compliance question unless the agency policy is determined to be law or regulation. USPAP does not establish who or which assignments must comply; thus, the JURISDICTIONAL EXCEPTION RULE cannot be applied to a decision to comply with USPAP. To the contrary, a jurisdictional exception occurs when an applicable law or regulation precludes compliance with USPAP; therefore no decision is necessary.

Another issue raised by this question relates to the USPAP requirements that apply to a preliminary estimate of value. USPAP does not define preliminary estimate of value. However, it is the nature of the service, not the label applied, that defines the service. An appraisal is defined as *the act or process of developing an opinion of value; an opinion of value*. If the service is an appraisal as defined in USPAP, then STANDARDS 1 and 2 apply to the preliminary estimate of value.

104. WHEN COMPLIANCE WITH USPAP IS PRECLUDED BY LAW OR REGULATION

Question: Can a jurisdictional exception take away from the requirements of USPAP?

Response: Yes. The JURISDICTIONAL EXCEPTION RULE provides for the situation in which parts of USPAP may be precluded by law or regulation in certain jurisdictions. It states:

If any applicable law or regulation precludes compliance with any part of USPAP, only that part of USPAP becomes void for that assignment.

As stated in the Comment to the JURISDICTIONAL EXCEPTION RULE:

The JURISDICTIONAL EXCEPTION RULE provides a saving or severability clause intended to preserve the balance of USPAP if compliance with one or more of its parts is precluded by the law or regulation of a jurisdiction. When an appraiser properly follows this Rule in disregarding a part of USPAP, there is no violation of USPAP.

The Comment to the JURISDICTIONAL EXCEPTION RULE also includes language that helps appraisers recognize laws and regulations.

105. PROBATE COURT STATUTE BASING THE APPRAISAL FEE ON THE APPRAISED VALUE

Question: A property is being appraised for a probate court in a state which has a statute stipulating that appraisal fees for these assignments shall be based on the appraised value of the property. Does USPAP allow me to appraise the property under this compensation arrangement?

Response: Yes. This is an example where the JURISDICTIONAL EXCEPTION RULE applies. In order to comply with the requirements of the JURISDICTIONAL EXCEPTION RULE, the appraiser must disclose in the appraisal report the reason(s) that prohibit compliance with USPAP, and cite the basis for the jurisdictional exception.

106. APPROPRIATE SOURCES FOR JURISDICTIONAL EXCEPTION

Question: My client's attorney has told me to invoke the JURISDICTIONAL EXCEPTION RULE to avoid mentioning in my appraisal report an underground storage tank (UST) that I know exists in the property. The attorney did not provide any reference or citation of law or regulation justifying this action. Can I follow the instruction from this attorney, who is representing my client?

Response: No. Use of the JURISDICTIONAL EXCEPTION RULE is triggered by a conflict between the requirements of USPAP and the law or regulation of a jurisdiction, not by client discretion.

The JURISDICTIONAL EXCEPTION RULE states:

If any applicable law or regulation precludes compliance with any part of USPAP, only that part of USPAP becomes void for that assignment..

This Rule provides a saving or severability clause when compliance with a part or parts of USPAP is precluded by law or regulation. The first sentence of the Comment to the Rule states:

The JURISDICTIONAL EXCEPTION RULE provides a saving or severability clause intended to preserve the balance of USPAP if compliance with one or more of its parts is precluded by the law or regulation of a jurisdiction. When an appraiser properly follows this Rule in disregarding a part of USPAP, there is no violation of USPAP.

The second paragraph in the Comment also provides explicit descriptions of laws and regulations that appraisers can use to determine when use of the JURISDICTIONAL EXCEPTION RULE is acceptable. It is important to note that the parameters described in the Comment apply whether the assignment is an appraisal, appraisal review, or an appraisal consulting assignment, or the type and definition of value is market value or some other value opinion, and for any intended use.

An attorney's instruction, without specific citation of law or regulation, is not the equivalent of law or regulation. Attorneys may offer legal opinions, but legislative bodies and courts make laws, and administrative agencies establish regulations. While an attorney is an expert in the practice of law, it is the court that decides if the facts in a matter support an attorney's representation of how established law applies to a specific set of facts.

Absent the citation of law or regulation, which should be cited in the report together with the part or parts of USPAP from which compliance is precluded in the assignment, the attorney's instruction is not acceptable as a basis to disregard a part or parts of USPAP applicable in the assignment.

107. VALUATION METHODS AND JURISDICTIONAL EXCEPTION RULE

Question: I am doing an appraisal assignment for a government agency that is subject to the provisions of The Uniform Relocation Assistance and Real Property Acquisitions Act of 1970, as Amended (commonly known as, the Uniform Act), and its implementing regulation, 49 CFR Part 24. They have provided me with a reference to a State Court of Appeals ruling which indicates that standing timber and landscaping impacted by a public project must be appraised based on the value it contributes to the subject property as a whole, and not as individual items. They have informed me that this appeals case is frequently cited in condemnation cases and almost always upheld by trial courts in this state. Based on this court decision, the agency has adopted a policy that all standing timber and landscaping be valued in this manner.

On this issue of landscaping, does using contributory value versus replacement value constitute [a.] a jurisdictional exception or [b.] an assignment condition, because it is applied to all such government agency assignments in this state?

Response: The JURISDICTIONAL EXCEPTION RULE does not apply in this circumstance since there are no requirements in USPAP addressing the proper valuation techniques for standing timber and landscaping. The Rule only applies when there is a conflict between the requirements of USPAP and the applicable law or regulation of a jurisdiction.

USPAP requires that in the development of an appraisal, an appraiser must be aware of, understand, and correctly employ those recognized methods and techniques that are necessary to produce a credible appraisal. Further, the COMPETENCY RULE requires recognition of, and compliance with, laws and regulations that apply to the appraiser or to the assignment.

The agency policy on the valuation of standing timber and landscaping is an assignment condition and must be considered in the scope of work decision. However, an appraiser cannot perform an

assignment with a condition that would produce assignment results which are not credible in the context of the intended use.

108. CLIENT REQUIREMENT TO DISREGARD MARKET VALUE CHANGES PRIOR TO EFFECTIVE DATE (NEW)

Question: I am aware of the ASB's June 2008 Q&A which addressed the implementing regulation, 49 CFR Part 24, for *The Uniform Relocation Assistance and Real Property Acquisitions Act of 1970*, as Amended (the Uniform Act). The topic of this FAQ is the relationship of Standard Rule 1-4(f) and "Before Acquisition Value." The ASB pointed out that such a situation does not create a jurisdictional exception under USPAP, but is rather an assignment condition.

My state has a similar law that requires the appraiser to disregard any decrease or increase in market value of the property prior to the effective date of value caused by the public improvement for which the property is being acquired. Is this state law a jurisdictional exception under USPAP?

Response: No. The state law is not a jurisdictional exception in this case. USPAP SR 1-4(f) becomes applicable in an assignment only if the scope of work includes the analysis of anticipated improvements:

When analyzing anticipated public or private improvements, located on or off the site, an appraiser must analyze the effect on value, if any, of such anticipated improvements to the extent they are reflected in market actions. (Bold added for emphasis)

As is pointed out in the response to FAQ 313 the key word in SR 1-4(f) is "**When**." Your state law does not conflict with USPAP because the word **When** indicates that SR 1-4(f) is only applicable in the circumstance that public or private improvements must be analyzed in order to develop credible assignment results.

The JURISDICTIONAL EXCEPTION RULE states, in part:

In an assignment involving a jurisdictional exception, an appraiser must:

- 1. identify the law or regulation that precludes compliance with USPAP;*
- 2. comply with that law or regulation;*
- 3. clearly and conspicuously disclose in the report the part of USPAP that is voided by that law or regulation; and*
- 4. cite in the report the law or regulation requiring this exception to USPAP compliance.*

109. CLIENT REQUIREMENT TO DISREGARD THE INFLUENCE ON MARKET VALUE OF PUBLIC IMPROVEMENTS (NEW)

Question: I am aware that development of an opinion of market value also requires development of an opinion of reasonable exposure time linked to the value opinion. The assignment I am working on has an assignment condition under the *Uniform Appraisal Standards for Land Acquisitions* (the Yellow Book) that requires me to disregard any decrease or increase in market value of the property prior to the effective date of value that is caused by the public improvement for which the property is being acquired. My research indicates the time frames of buyers and

sellers are often influenced by pending public improvement projects. Does this requirement represent a jurisdictional exception?

Response: Yes. In this case, the implementing law for what is commonly known as the Yellow Book *precludes* you from complying with the USPAP requirement stated in the Comment to USPAP SR 1-2(c), which requires an appraiser to develop an opinion of reasonable exposure time linked to the value opinion, when exposure time is a component of the definition of value. In contrast, the Yellow Book provides that “the appraiser shall not link an estimate of market value for federal land acquisitions to a specific exposure time.”

110. IS A “WAIVER VALUATION” A JURISDICTIONAL EXCEPTION? (NEW)

Question: The Federal Highway Administration (FHWA) permits a “waiver valuation.” To quote 49 CFR 24.102(c)(2), “The term waiver valuation means the valuation process used and the product produced when the agency determines that an appraisal is not required, pursuant to 24.102(c)(2) appraisal waiver.” Is this an application of the JURISDICTIONAL EXCEPTION RULE?

Response: No. There is no jurisdictional exception in the situation described. USPAP does not establish who or which assignments must comply. An agency may determine that an appraisal is not required for a specific situation, and may elect to rely on a waiver valuation.

An appraiser who is required to practice under USPAP, or chooses to do so, must still comply with USPAP. However, nothing in the definition of waiver valuation *precludes the appraiser from complying with USPAP*. Compliance with USPAP sometimes requires an appraiser to develop an expanded level of analyses, or communicate results with a different minimum set of requirements, distinct from what might be desired by a particular intended use or user. These additional obligations may impact an appraiser’s decision whether they *choose* to accept the assignment.

It is important that an appraiser take the time and effort to clearly understand all the assignment elements, and make an appropriate scope of work decision that complies with the appraiser’s obligation to be able to demonstrate that the scope of work is sufficient to produce credible assignment results.

111. CLIENT REQUIREMENT TO ASSUME NO CONTAMINATION EXISTS (NEW)

Question: The Federal Highway Administration (FHWA) publishes a “Guide for Preparing an Appraisal Scope of Work.” One of the items listed is that the property being acquired should be “appraised as if free and clear of contamination,” unless otherwise specified. Is this a jurisdictional exception, extraordinary assumption, or hypothetical condition?

Response: This situation is not an application of the JURISDICTIONAL EXCEPTION RULE. Rather, if contamination is an aspect of the valuation, the situation calls for either an extraordinary assumption or a hypothetical condition. In the DEFINITIONS section, an extraordinary assumption is defined as:

an assumption, directly related to a specific assignment, as of the effective date of the assignment results, which, if found to be false, could alter the appraiser’s opinions or conclusions.

A hypothetical condition is defined as:

a condition, directly related to a specific assignment, which is contrary to what is known by the appraiser to exist on the effective date of the assignment results, but is used for the purpose of analysis.

If the contamination status of the property is uncertain and cannot be determined, an extraordinary assumption is appropriate. If the property is known to be contaminated, a hypothetical condition to the contrary would be required.

112. JURISDICTIONAL EXCEPTION AND CONFIDENTIALITY

Question: I was recently hired to perform an appraisal assignment for a government agency. The agency has a regulation that requires me to provide the appraisal report to other government agencies if requested. Does this regulation create a jurisdictional exception to the Confidentiality section of the ETHICS RULE?

Response: No. The Confidentiality section of the ETHICS RULE reads, in part:

An appraiser must not disclose: (1) confidential information or (2) assignment results to anyone other than:

- *the client;*
- ***persons specifically authorized by the client;***
- *state appraiser regulatory agencies;*
- ***third parties as may be authorized by due process of law; and***
- *a duly authorized professional peer review committee except when such disclosure to a committee would violate applicable law or regulation. (Bold added for emphasis.)*

Since the Confidentiality section of the ETHICS RULE allows for the disclosure of confidential information to *persons specifically authorized by the client* and *third parties as may be authorized by due process of law*, the JURISDICTIONAL EXCEPTION RULE would not apply.

APPRAISAL DEVELOPMENT – CLIENT ISSUES

113. IDENTIFICATION OF THE CLIENT

Question: Who is the appraiser’s client?

Response: USPAP defines the client as:

The party or parties who engage, by employment or contract, an appraiser in a specific assignment.

Comment: The client may be an individual, group, or entity, and may engage and communicate with the appraiser directly or through an agent.

114. PAYMENT BY A PARTY OTHER THAN THE CLIENT

Question: I am an appraiser whose practice includes both residential and commercial appraisal assignments. Recently it has become very common for some clients to require me to pick up the check for the appraisal fee from the property owner. This takes place in both residential and commercial assignments. Since I am being paid directly by the property owner, does the property owner become the client?

Response: No. USPAP defines the client as:

The party or parties who engage, by employment or contract, an appraiser in a specific assignment.

Comment: The client may be an individual, group, or entity, and may engage and communicate with the appraiser directly or through an agent.

The act of the property owner or any other entity paying the appraiser does not make them the client under USPAP. However, state law could take precedence over USPAP in this situation. Therefore, you should contact the pertinent jurisdictions to ensure that there is not a conflict between applicable law and USPAP.

Situations may arise, especially in certain mortgage lending related assignments, in which this payment arrangement is not permitted.

115. DIFFERENCE BETWEEN CLIENTS AND INTENDED USERS

Question: What is the difference between a client and an intended user?

Response: The term client is defined in the DEFINITIONS section as:

The party or parties who engage, by employment or contract, an appraiser in a specific assignment.

The term intended user is defined as:

the client and any other party as identified, by name or type, as users of the appraisal, appraisal review, or appraisal consulting report, by the appraiser on the basis of communication with the client at the time of the assignment.

Eventual receipt of a copy of an appraisal, appraisal review, or appraisal consulting report does not make the recipient an intended user. To be an intended user the recipient must have been identified as such by the appraiser.

116. APPRAISAL MANAGEMENT COMPANY AS AUTHORIZED AGENT FOR A CLIENT

Question: I accept assignments from an Appraisal Management Company (AMC) that has informed me they are an authorized agent for the lenders they represent. The AMC does not want me to list their name as the client, and asks that I only list the name of the lender they are representing. USPAP says the appraiser's client is the party who engages the appraiser. Is it ethical to omit the AMC's name as the client on my reports?

Response: Yes. If the AMC is acting as a duly authorized agent for a lender, identifying only the lender as your client is acceptable.

117. CAN AN APPRAISAL MANAGEMENT COMPANY BE THE CLIENT? (NEW)

Question: I received an appraisal order from an Appraisal Management Company (AMC) which has requested to be identified as the client in the appraisal report. The AMC will not provide its client's name. Does USPAP allow me to identify the AMC as the client if the AMC will not disclose the name of its client?

Response: There is nothing in USPAP that precludes an AMC from being a client; however, appraisers must comply with all applicable assignment conditions. Assignment conditions required by some users of appraisal services, including those prepared for federally-regulated financial institutions, specify who the client must be.

Therefore, the AMC may be the client under USPAP, but there could be additional applicable assignment conditions depending on the intended use and intended users.

Having an AMC as the client can be similar to the situation in which an appraiser is engaged by an attorney. The identity of the party that engaged the attorney might not be made available to the appraiser, but USPAP does not preclude the appraiser from naming the attorney as the client.

118. CLIENT CANNOT BE IDENTIFIED

Question: I was recently asked to perform a real estate appraisal assignment, but the individual that contacted my firm was not the client and indicated that the client could not be identified. Can I accept this assignment and comply with USPAP?

Response: No. Standards Rule 1-2 states, in part:

In developing a real property appraisal, an appraiser must:

(a) *identify the client and other intended users;*

This does not preclude a third party, acting as an agent for the client, from ordering the appraisal. In all assignments, the appraiser must know the identity of the client in order to proceed; however, the appraiser is not required to disclose the identity of the client in the appraisal report. Refer to STATEMENT ON APPRAISAL STANDARDS NO. 9 (SMT-9), *Identification of Intended Use and Intended Users*, for further clarification.

119. SUBSEQUENT USER REQUESTS A RELIANCE LETTER

Question: **I delivered an appraisal report to my client. A week later, an entity other than one of the identified intended users contacted me and asked that I provide a reliance letter, enabling them to rely on the appraisal report for their own investment use. My client says they have no problem with me doing that. Can I provide this entity with such a letter, even though I had not originally identified them as an intended user?**

Response: No. You cannot add what is in effect a new intended user after the completion of an assignment, no matter what terminology you use.

USPAP defines Intended User as:

*The client and any other party as identified, by name or type, as users of the appraisal, appraisal review, or appraisal consulting report by the appraiser on the basis of communication with the client **at the time of the assignment.** (Bold added for emphasis)*

The proper way to handle this is to initiate a new assignment with this entity as the client and provide them an appraisal, being careful to develop an appropriate scope of work consistent with the intended use of the new intended user(s).

This new assignment could be based on virtually the same data and analysis, and the value conclusion might be the same. However, in the new assignment you must consider the assignment elements most appropriate to the scope of work for the new client, intended users, and intended use for the assignment results, which could well be different from those of your original client.

120. READDRESS OR TRANSFER

Question: **Is it acceptable to readdress or transfer a completed appraisal report?**

Response: No. Once a report has been prepared for a named client or clients, the appraiser cannot readdress or transfer the report to another party. Simply changing the client name on the report cannot change or replace the original appraiser-client relationship. Therefore, this action is misleading.

However, you can consider the request as a new assignment. In so doing, you may establish a new appraiser-client relationship and appraise the property for this new client.

Additional information can be found in Advisory Opinion 26, *Readdressing (Transferring) a Report to Another Party*. Important considerations, such as the handling of confidential information and other factors, are addressed in Advisory Opinion 27, *Appraising the Same Property for a New Client*.

121. READDRESSING WITH LENDER RELEASE

Question: I am aware of two advisory opinions, AO-26, *Readdressing (Transferring) a Report to Another Party*, and AO-27, *Appraising the Same Property for a New Client*. Does that guidance still apply if Lender A releases me to perform another assignment, or can I just readdress the report to Lender B since I have obtained a release?

Response: Yes; the guidance still applies. It is never permissible to readdress a report by simply changing the client's name on a completed report, regardless of whether the first client gave a release. The request from Lender B must be treated as a new assignment.

Further guidance can be found in the Obtaining a Release section of AO-27.

122. IDENTIFICATION OF INTENDED USERS

I know that it is my responsibility to identify the intended users when I perform an assignment, and that USPAP defines intended user as the client and any other party as identified, by name or type, as users of the appraisal, appraisal review, or appraisal consulting report by the appraiser on the basis of communication with the client.

However, I need clarification regarding whether certain parties should automatically be considered intended users in certain circumstances described below.

Question: (1.) If I perform an appraisal for estate tax purposes and the client will provide my report to the IRS with her tax return, must the IRS be identified as an intended user in this situation?

Question: (2.) I have been hired by an attorney representing a husband in a divorce to appraise certain assets held in the marital estate and to appear as an expert witness. I know my report will go to the court as well as to the parties on the other side of the litigation. Must the court and/or the parties on the other side of the litigation be identified as intended users?

Question: (3.) I frequently perform appraisals for purposes of purchase price allocation. The corporation that is my client will use the values for financial reporting purposes. My reports are provided to the auditors of the corporations for their review as part of the audit process. In such cases, must the auditors be identified as intended users?

Question: (4.) I am appraising a property for a regulated lender. I know that my appraisal will be reviewed by the bank's outside auditors and the OCC reviewers. Must the auditors and OCC reviewers be identified as intended users?

Response: The answer for each of the four questions is no. Intended users are identified by the appraiser through communication with client and are not established based on who might receive or use the report.

The definition of intended user has a specific meaning in USPAP. In the context of the USPAP definition of intended user, the fact that the IRS, the court, an independent auditor, or the OCC in

the above cases will use your report for review, audit, or other purposes does not automatically make them intended users. These parties receive the report through established processes of disclosure or regulation.

One way to understand the concept is to think about what the *intended use* is for each party. The appraiser must identify both the intended users and the intended use of the appraisal, because these two factors affect many aspects of the appraisal assignment, such as the appropriate scope of work and the appropriate type of report.

In each case, the use of the report by these other parties is different from the intended use the appraiser identified, which was related to the client's use. Such other parties may be evaluating the decision made by the appraiser's client to obtain an appraisal, as well as the appraisal results, and other matters of which the appraiser may not be aware. As an example, the client filing the estate tax return is using the appraisal as an indication of the amount to state on the tax form. However, the IRS may use the appraisal report to determine whether the value reported on the tax return is adequately supported, whether the IRS agrees with the value, and/or whether the IRS should challenge the taxpayer because they disagree with the value.

As indicated in STATEMENT ON APPRAISAL STANDARDS NO. 9 (SMT-9), *Identification of Intended Use and Intended User*:

Parties who receive a copy of an appraisal, appraisal review, or appraisal consulting report as a consequence of disclosure requirements applicable to an appraiser's client do not become intended users of the report unless they were specifically identified by the appraiser at the time of the assignment.

123. ADDRESSEES, CLIENTS, AND INTENDED USERS

Question **If the party to whom an appraisal report is addressed is the client and is also the only intended user, does USPAP require the report to state the intended user by name or type?**

Response: While USPAP requires all reports to state the client and any other intended user(s), USPAP does not dictate how this should be done. When there is only a single intended user (the client), a simple statement as part of the salutation may be sufficient; however, in other cases, it may not be adequate. The report must clearly and accurately set forth the appraisal in a manner that will not be misleading and must contain sufficient information to enable intended users to understand the report properly.

The purpose of reporting requirements related to client and intended user identification is to: (1) ensure that the client and any other intended users can recognize their relationship to the assignment and report; and (2) ensure that unintended users will not be misled by notifying them that they are neither the client nor an intended user.

STATEMENT ON APPRAISAL STANDARDS NO. 9 (SMT-9), *Identification of Intended Use and Intended Users*, provides extensive information on this topic in addition to several examples of statements that may be appropriate for inclusion in a report, such as the following: *This report is intended for use only by (identify the client) and (identify any other intended users by name or type). Use of this report by others is not intended by the appraiser.*

124. APPRAISING WITHOUT KNOWING THE INTENDED USE OR INTENDED USER

Question: Does USPAP allow me to appraise a property without knowing the intended use or user if there is an agreed upon scope of work?

Response: No. USPAP requires an appraiser to identify the intended use and any intended users by name or type prior to determining the scope of work in an appraisal assignment.

125. ARE BORROWERS INTENDED USERS?

Question: Frequently, the borrower in a mortgage finance transaction is provided with a copy of the appraisal report; in most cases, the appraiser knows that the borrower will be receiving a copy of the appraisal report. When the appraiser is aware that the borrower or any other third party will receive a copy of the appraisal, does this make that third party an intended user?

Response: No. The fact that a borrower or anyone else receives a copy of the appraisal report does not make them an intended user. The concept of an intended user in USPAP is framed within the context of the appraiser-client relationship. An intended user is defined in USPAP as:

the client and any other party as identified, by name or type, as users of the appraisal, appraisal review, or appraisal consulting report by the appraiser on the basis of communication with the client at the time of the assignment.

There are several things to note in this definition. First, intended users of the appraisal report must be identified by the appraiser. Secondly, this identification is made at the time the appraiser is engaged for the assignment so the appraiser can make a prudent judgment about the scope of work to apply in the assignment and the level of detail to include in the report.

It is also worth noting that the concept of intended use and intended users are related to the type and definition of value in an assignment. Appraisal reports for loan transactions are typically used to substantiate the real property's market value as underlying collateral for a particular loan. The fact that the lending institution is required by law or regulation to make certain disclosures to the borrower about the loan and the basis for the loan decision does not alter the intended use, intended users, or type and definition of value in the appraisal assignment.

STATEMENT ON APPRAISAL STANDARDS NO. 9 (SMT-9), *Identification of Intended Use and Intended User* further clarifies this issue by stating:

A party receiving a report copy from the client does not, as a consequence, become a party to the appraiser-client relationship.

Parties who receive a copy of an appraisal, appraisal review, or appraisal consulting report as a consequence of disclosure requirements applicable to an appraiser's client do not become intended users of the report unless they were specifically identified by the appraiser at the time of the assignment.

126. IDENTIFYING INTENDED USERS BY TYPE

Question: I recently received a request for an appraisal assignment. The potential client has indicated that there will be other intended users, but has not identified the intended users specifically. Is it acceptable to identify the intended users by type?

Response: Yes. STATEMENT ON APPRAISAL STANDARDS No. 9, *Identification of Intended Use and Intended Users* states, in part:

*Neither the client nor the appraiser is obligated to identify an intended user by name. If identification by name is not appropriate or practical, an appraiser's client and **the appraiser may identify an intended user by type.*** (Bold added for emphasis)

Therefore, in this situation the appraiser should identify the type of intended users applicable to the assignment, (e.g., secondary mortgage market participants).

127. ENGAGED DIRECTLY BY THE HOMEOWNER

Question: I was contacted by homeowners who want me to perform an appraisal of their home to be used for a loan at a federally regulated financial institution. What are my responsibilities in this potential assignment?

Response: It is an appraiser's responsibility to disclose to the homeowners that a lender or its agent is required by Title XI of FIRREA to directly engage the services of an appraiser in a federally related transaction. If the homeowners still want to engage you, your disclosure allows you to accept the assignment.

Additional information can be found in Advisory Opinion 25, *Clarification of the Client in a Federally Related Transaction*.

128. CLIENT APPROVAL FOR FUTURE ASSIGNMENTS

Question: Some of my clients include a condition in engagement correspondence that addresses future assignments for the same subject property. Specifically, my acceptance of the assignment requires that I agree to obtain client approval before I accept future assignments related to the subject from another party. Advisory Opinion 27, *Appraising the Same Property for a New Client* states that USPAP does not require a release to accept the new assignment. Can I accept assignments where the client requires a release for future assignments related to the subject?

Response: Yes. Appraisers are often subject to agreements that exceed the requirements of USPAP. These additional client requirements are permissible so long as they do not conflict with the requirements of USPAP. Although USPAP does not require obtaining approval from a prior client before accepting an assignment to appraise the same property for a new client, a client can establish such a requirement.

129. REQUEST TO MODIFY A COMPLETED APPRAISAL REPORT (NEW)

Question: I have completed an appraisal assignment for a client. The report was completed using the 2005 version of the Uniform Residential Appraisal Report (URAR). The client has requested that I remove one of the comparable properties from the report because, in the underwriter's opinion, it is not sufficiently similar to the subject property. If I do this, will my action comply with USPAP?

Response: Such an action has the potential to be misleading. Certification item #15 of the 2005 URAR states the following:

“I have not knowingly withheld any significant information from this appraisal report and, to the best of my knowledge, all statements and information in this appraisal report are true and correct.” (Bold added for emphasis)

You initially concluded that the comparable you are being asked to remove was relevant in developing and communicating the assignment results. If this opinion has not changed, and you subsequently remove a comparable listing or sale from the appraisal report and sign the certification for this specific report format, it would likely be misleading because information you consider to be significant is being knowingly withheld.

In addition, Standards Rule 2-2(b)(viii) which addresses the content of a Summary Appraisal Report includes the following requirement:

summarize the information analyzed, the appraisal methods and techniques employed, and the reasoning that supports the analyses, opinions, and conclusions; exclusion of the sales comparison approach, cost approach, or income approach must be explained;
(Bold added for emphasis)

If the comparable is removed as requested by the client, information that was analyzed would no longer be summarized in the report as required by this Standards Rule.

APPRAISAL DEVELOPMENT – APPRAISAL DATES

130. EFFECTIVE DATE OF THE APPRAISAL

Question: The Standards Rules require all appraisal reports to disclose the effective date of the appraisal. Must the date be reported as a specific day, month, and year, or is it sufficient to simply provide the month and year?

Response: The effective date of an appraisal is determined by the intended use and the intended user. In most cases the intended use and/or the intended user dictates that the date provided is a specific day, month, and year. However, in some circumstances it may be acceptable to be less specific, (e.g., in a prospective appraisal assignment when an exact date cannot be accurately determined at the time the assignment is completed).

131. DATE OF APPRAISAL

Question: What is the date of appraisal?

Response: The date of the appraisal is an ambiguous term. The appropriate terminology is either the effective date of the appraisal, to reflect the time period relevant to the assignment results, or the date of the report, which indicates when the appraisal analysis was completed.

132. DATE OF VALUE

Question: Is the effective date of the appraisal the same as the date of value?

Response: Yes.

133. CITATION OF EFFECTIVE DATE

Question: I've been engaged for a real property appraisal review assignment and have a question about the appraisal report under review. Does USPAP require the date of value to be cited each time the opinion of value is stated in the appraisal report?

Response: No. USPAP does not require the appraiser to state the effective date of the appraisal with each statement of the value opinion. In a real property appraisal report, the requirements that apply to reporting the effective date can be found in Standards Rules 2-2(a)(vi) for a Self-Contained Appraisal Report, 2-2(b)(vi) for a Summary Appraisal Report, and 2-2(c)(vi) for a Restricted Use Appraisal Report. Each of these appraisal reporting options simply requires the appraisal report to “state the effective date of the appraisal and the date of the report.”

However, you should take care to assure that intended users are not misled, such as by stating the effective date of value in a manner which does not clearly establish the context for the value opinion. In most instances, reporting the value opinion with the effective date of the appraisal, especially when the effective date is significantly different (retrospective or prospective) from the date of the report, assists intended users to clearly understand the context for the value opinion.

134. CHANGING THE EFFECTIVE DATE

Question: I recently had a client contact me and ask me to change the effective date of my appraisal, to make it one week after the effective date shown in my report. Does USPAP permit me to simply change the effective date without taking additional steps?

Response: No. As indicated in the SCOPE OF WORK RULE, the effective date of the appraiser’s opinions and conclusions is an assignment element.

If the client is asking for an appraisal with a different effective date, the appraiser needs to determine the appropriate scope of work to produce credible assignment results for this request. Such a request would need to be considered a new assignment, but that does not necessarily require starting from scratch. As with all new assignments, the appraiser must decide the appropriate scope of work to produce credible assignment results. This would include a decision as to whether or not it was necessary to perform another inspection, as well as the extent of any additional research and analyses that might be required. The scope of work for the new assignment can be different from the scope of work completed in the earlier assignment. As with any assignment, the appraiser might be able to use information and analyses developed for a previous assignment.

135. DOES CHANGING THE SALE PRICE RESULT IN A NEW ASSIGNMENT?

Question: I recently completed an appraisal for mortgage financing purposes in a purchase transaction and delivered the report to my client. My opinion of value did not support the pending sale price. As a result, the purchase transaction was not consummated. However, one week later the buyer and seller entered into a new purchase agreement where the sale price coincided with my appraised value. My client asked if I can provide a revised report that includes the analysis of the newly agreed-upon sale price. To provide a revised appraisal report, must I consider the client’s request as a new assignment?

Response: If the client does not require a more current effective date, USPAP would not mandate treating the request as a new assignment. However, if the client does require a more current effective date, the request must be treated as a new assignment.

In this example, regardless of whether the effective date is changed, the date of the report would have to change to accurately reflect the appraiser’s consideration of the newly obtained agreement of sale. Because the new purchase agreement was obtained *after* the date of the first report, the revised report would need to have a date of report that is the same as or later than the date the new purchase agreement was obtained by the appraiser.

In addition, the new report would also need to reflect the appraiser’s analysis of the prior agreement of sale. In the development of an appraisal, an appraiser is required under Standards Rule 1-1(b), to *not commit a substantial error of omission or commission that significantly affects an appraisal*. Since information about the prior agreement of sale is known by the appraiser and that information is relevant to the appraisal problem, it must be considered.

Additional related guidance may be found in Advisory Opinion 3, *Update of a Prior Appraisal*; Frequently Asked Question #197 *Does a New Assignment Require Starting Over?*; Frequently Asked Question #215 *Offers to Purchase Subject Property*; and FAQ #134 *Changing the Effective Date*.

136. CURRENT VALUE OPINIONS FOR PROPOSED IMPROVEMENTS

Question: Does USPAP address the performance of a current appraisal for real property with proposed improvements?

Response: Yes. Advisory Opinion 17, *Appraisals of Real Property with Proposed Improvements*, offers advice from the ASB regarding a current real property appraisal based on the assumption of completion of improvements.

137. PROPOSED IMPROVEMENTS – CURRENT AND PROSPECTIVE VALUE OPINIONS

The real property that I am appraising involves proposed improvements, and the client needs to know my opinion of market value as if the proposed improvements are complete, both as of the current date and as of a future date. I have two questions.

Question: (1) When the date of value is a current date, is my opinion developed on the basis of a hypothetical condition or an extraordinary assumption?

Response: When the date of value is a current date, and the appraisal is of a property with proposed improvements as if those improvements were complete on a current date of value, the value opinion is developed on the basis of a hypothetical condition.

This is because the appraiser knows the proposed improvements do not, in fact, exist on that current date of value. Completing an analysis on the condition that something the appraiser knows to be contrary to what exists, but is supposed for purposes of reasonable analysis, is using a hypothetical condition in that analysis. (See Standards Rule 1-2(g))

Question: (2) When the date of value is a future date, when the proposed improvements will be complete, is my opinion developed on the basis of a hypothetical condition or an extraordinary assumption?

Response: When the date of value is a future date and the appraisal is of a property with proposed improvements that are expected to be complete on or before that future date, the value opinion is developed on the basis of an extraordinary assumption.

This is because the appraiser presumes the proposed improvements will, in fact, exist as of that future date of value. Completing the analysis on the condition that something the appraiser reasonably believes will exist as of a future date is using an extraordinary assumption in that analysis. (See Standards Rule 1-2(f))

138. EFFECTIVE DATE AND DATE OF THE REPORT (NEW)

Question: I have been engaged to perform a real property valuation assignment. The assignment is to develop an opinion of the market value of the subject property in its current “as-is” condition. USPAP states, “Current appraisals occur when the effective date of the appraisal is contemporaneous with the date of the report.” In this context, what defines contemporaneous with the date of the report?

Response: In USPAP, there are three different types of appraisals: retrospective, current, and prospective. STATEMENT ON APPRAISAL STANDARDS NO. 3 (SMT-3) addresses retrospective appraisal assignments, while STATEMENT ON APPRAISAL STANDARDS NO. 4 (SMT-4) addresses prospective appraisal assignments.

“Current” appraisal assignments are based on the effective date of the appraisal being contemporaneous with the date of the report. Contemporaneous means arising, existing or occurring during the same time period. In this context contemporaneous is not intended to mean simultaneous. Because the “same time period” may very well differ from assignment to assignment, one single specific time period cannot be provided that can be used for all assignments. However, for an assignment to include a current appraisal opinion there must not have been a significant change in the property characteristics or market conditions between the effective date of the appraisal and the date of the report.

139. COMPETENCY AS OF EFFECTIVE DATE OF THE APPRAISAL

Question: **Can an appraiser prepare a retrospective appraisal, with an effective date of appraisal as of five years ago, if that appraiser wasn’t even an appraiser five years ago?**

Response: Yes. The appraiser must comply with the COMPETENCY RULE at the time the appraiser develops the appraisal, regardless of the effective date of the appraisal (date of value). If the appraiser is to develop a value opinion, be it retrospective, prospective, or current, the appraiser must be able to deal with the nuances of such an assignment at the time he or she is performing the assignment (e.g., to research data associated with the retrospective, prospective, or current effective date of the appraisal and to analyze the data in light of market conditions as of that date). It is not necessary for the appraiser to be, or to have been, a competent appraiser as of the effective date of the appraisal.

An appraiser could develop a retrospective appraisal with an effective date of the appraisal that is prior to the appraiser’s own date of birth. Likewise, an appraiser could develop a prospective appraisal with an effective date of the appraisal that occurs after the date of his or her own death. These would be legitimate assignments that could be completed according to USPAP. In such cases the appraiser could not be considered to be a competent appraiser as of the effective dates of those appraisals.

140. CURRENT AND RETROSPECTIVE VALUE OPINIONS WITHIN ONE REPORT

Question: **I have been asked to perform an appraisal assignment that includes providing a retrospective value as well as a current value. Can I report both value opinions within one appraisal report?**

Response: Yes; you can communicate both opinions of value within one appraisal report. Since two opinions of value (appraisals) are included in the report, both opinions must be developed in conformance with the appropriate STANDARD (1, 6, 7, or 9).

141. POST-VALUE DATE INFORMATION IN RETROSPECTIVE APPRAISALS

Question: The real property that I am appraising is in a market that was impacted by the major regional employer’s closing of its facility three years ago. My client needs an opinion of value as of a date that preceded any knowledge of the facility being closed. Is it appropriate to include the fact that the facility closed in my retrospective appraisal?

Response: A thorough review of STATEMENT ON APPRAISAL STANDARDS NO. 3 (SMT-3), *Retrospective Value Opinions* is necessary to properly deal with the problem the appraiser faces in this question. The most relevant information in SMT-3 states:

A retrospective appraisal is complicated by the fact that the appraiser already knows what occurred in the market after the effective date of the appraisal. Data subsequent to the effective date may be considered in developing a retrospective value as a confirmation of trends that would reasonably be considered by a buyer or seller as of that date. The appraiser should determine a logical cut-off because at some point distant from the effective date, the subsequent data will not reflect the relevant market. This is a difficult determination to make. Studying the market conditions as of the date of the appraisal assists the appraiser in judging where he or she should make this cut-off. In the absence of evidence in the market that data subsequent to the effective date were consistent with and confirmed market expectations as of the effective date, the effective date should be used as the cut-off date for data considered by the appraiser.

The appraiser cannot include in the analyses the fact that an event subsequent to the date of value in a retrospective appraisal changed the market conditions that existed as of the date of value. Using such information is not consistent with the intended use of the appraisal because buyers and sellers had no knowledge or expectation of that subsequent event as of the date of value.

However, an appraiser may disclose facts in an appraisal report about events that occurred subsequent to the date of value in an appraisal. Such a disclosure is particularly appropriate when the appraiser has reason to believe the intended users of the report could be misled by not knowing those facts in the current time frame, when the appraisal is being used.

142. APPRAISAL BASED ON CURRENT AND PROSPECTIVE DATES OF VALUE

Question: My client, a federally regulated lender, has requested a market value appraisal for use in financing a commercial property development project. The client’s stated loan conditions include a requirement that the property be leased before the onset of its development. The client stated they need (1) an opinion of market value for the property that actually exists as of a current date, which is the site with its entitlements and under the zoning in effect as of the current date, and (2) an opinion of market value as of the future date (a prospective value opinion) when the property will be physically completed and occupied under the pre-leasing terms and conditions. Must I develop both of these opinions of value and, if so, why?

Response: Yes; the client needs both opinions to aid in identifying its project development loan risk and respond to regulatory requirements and guidelines.

The client’s project development loan decision would typically be based, in part, on your analysis of highest and best use (See Standards Rule 1-3(b)) and the feasibility of the development project (See Standards Rules 1-2(e), Comment on (i)-(v)).

The value of the site, with its entitlements and under the zoning in effect as of a current date (i.e., without use of a hypothetical condition), is an important component in your analysis and it provides the client with information necessary to identify development risk and determine appropriate loan terms and conditions. Absent other factors, this value opinion could be developed without use of either an extraordinary assumption or a hypothetical condition. The subject in the current appraisal is the site that actually exists with the zoning (including any entitlements) in effect as of that date.

The value of the property as of the prospective date, when it has been physically completed and leased under the pre-leasing terms and conditions, is also significant information the client would typically use in making its project development loan decision. Developing this value opinion typically requires the use of an extraordinary assumption because the subject in the prospective appraisal is the property as it is expected to exist as of that future date when physical development is complete and the property is leased in accordance with the lease terms and conditions.

143. USPAP COMPLIANCE IN RETROSPECTIVE APPRAISALS

Question: When preparing an assignment with a retrospective date of value, should the appraiser comply with the USPAP in effect as of the date of the appraisal or as of the date of report?

Response: Appraisers must comply with the USPAP edition in effect as of the date of the report. Only the data and the analyses of that date should be considered on a retrospective basis, not the Standards under which the assignment is performed.

144. RETROSPECTIVE APPRAISAL ASSIGNMENTS

Question: I was recently asked to complete a retrospective market value appraisal for which the effective date of the appraisal is two years prior to the date of the report. In researching this assignment I discovered several comparable sales that were listed and placed under contract prior to the effective date of the appraisal, but actually sold well after the effective date. Would it be appropriate to use only these sales in my sales comparison approach to value?

Response: In a retrospective appraisal the analysis should reflect the market conditions that existed on the effective date of the appraisal. Only using comparable sales information that was not available to the market place, or did not exist as of the effective date of the appraisal could be misleading because it would not reflect information available to the marketplace during that time period.

Retrospective appraisals and the use of data from the time period after the effective date are addressed in STATEMENT ON APPRAISAL STANDARDS NO. 3 (SMT-3), *Retrospective Value Opinions*. SMT-3 states, in part:

A retrospective appraisal is complicated by the fact that the appraiser already knows what occurred in the market after the effective date of the appraisal. Data subsequent to the effective date may be considered in developing a retrospective value as a confirmation of trends that would reasonably be considered by a buyer or seller as of that date. The appraiser should determine a logical cut-off because at some point distant from the effective date, the subsequent data will not reflect the relevant market. This is a difficult determination to make. Studying the market conditions as of the date of the appraisal assists the appraiser in judging where he or she should make this cut-off. In the

absence of evidence in the market that data subsequent to the effective date were consistent with and confirmed market expectations as of the effective date, the effective date should be used as the cut-off date for data considered by the appraiser.

While the effective date is not an absolute cut-off point for market data, the appraiser must use particular caution in applying it in these assignments.

Refer to SMT-3 for additional information.

APPRAISAL DEVELOPMENT – SCOPE OF WORK ISSUES

145. WHAT IS SCOPE OF WORK?

Question: What is scope of work?

Response: In basic terms, the scope of work is the work an appraiser performs to develop assignment results. USPAP defines scope of work as the type and extent of research and analyses in an assignment. Note that this definition excludes reporting.

146. APPLICABILITY OF SCOPE OF WORK RULE

Question: In my role as an appraiser, I perform many assignments that are not appraisal, appraisal review, or appraisal consulting services. Does the SCOPE OF WORK RULE apply to these assignments?

Response: No. The SCOPE OF WORK RULE applies only to appraisal, appraisal review, and appraisal consulting assignments.

Assignments other than appraisal, appraisal review, and appraisal consulting (for example, teaching appraisal courses, providing sales data, collecting market data, analyzing reproduction costs, developing educational texts) still require an appraiser to comply with those portions of USPAP that apply to appraisal practice. These include the DEFINITIONS, the PREAMBLE, the ETHICS RULE, the COMPETENCY RULE and the JURISDICTIONAL EXCEPTION RULE.

147. RESPONSIBILITY FOR THE SCOPE OF WORK DECISION

Question: Who determines the scope of work?

Response: It is the appraiser's responsibility to determine and perform the appropriate scope of work.

148. CLIENT SPECIFIES SCOPE OF WORK

Question: Is a scope of work specified by the client acceptable?

Response: The scope of work specified by the client is acceptable if it allows the appraiser to develop credible assignment results. If the scope of work specified by the client does not permit development of credible assignment results, the appraiser must either change the scope of work to what he or she determines is necessary to develop credible assignment results or withdraw from the assignment.

149. CLIENT REQUEST TO LIMIT SCOPE OF WORK TO NEW CLIENT NAME (NEW)

Question: An appraiser completed an appraisal for Client A. Client B received a copy of the appraisal from Client A and finds it acceptable for their purposes, but wants to be identified as the client in the appraisal report. Client B is aware that appraisers are prohibited from readdressing (or transferring) a completed report to a different client's name. As a result, Client B would like to engage the appraiser in a new assignment, limiting the appraiser's scope of work to only identifying them as the new client. Can the appraiser complete the assignment from Client B under these terms?

Response: No. USPAP requires the scope of work performed to produce credible assignment results. USPAP clearly establishes that the scope of work is determined by the appraiser. If a client's instructions (i.e., assignment conditions) limit the appraiser's scope of work in a new assignment to simply identifying a new client, the client, not the appraiser, has made the scope of work decision.

In addition, even if the appraiser accepted the client's proposed scope of work as his or her own, that scope of work may not be adequate to produce credible assignment results as required by USPAP.

As is the case with all assignments, when a client's assignment conditions are too restrictive to produce credible assignment results, an appraiser must decline or withdraw from an assignment, unless the appraiser can modify those assignment conditions to allow for credible assignment results.

150. THE IMPACT OF DIFFERENT CLIENTS ON ASSIGNMENT RESULTS WITH OTHERWISE IDENTICAL ASSIGNMENT ELEMENTS AND SCOPE OF WORK

Question: Assuming otherwise identical assignment elements and scope of work, will an appraiser's value opinion for an assignment be the same regardless of the appraiser's client?

Examples:

Assuming otherwise identical assignment elements and scope of work, will an appraiser's value opinion for an eminent domain assignment be the same regardless of whether the assignment is for the condemnee or the condemnor?

In a litigation assignment with otherwise identical assignment elements and scope of work, will the appraiser's value opinion be the same regardless of whether the appraiser was hired by the defendant or the plaintiff or a third-party?

In an appraisal prepared for a tax assessment appeal with otherwise identical assignment elements and scope of work, will the appraiser's value opinion be the same regardless of whether the appraiser was hired by the government or the taxpayer?

In an appraisal prepared for a gift donation for tax filing purposes with otherwise identical assignment elements and scope of work, will the appraiser's value opinion be the same regardless of whether the appraiser was hired by the IRS or the taxpayer?

Assuming otherwise identical assignment elements and scope of work, will an appraiser's value opinion be the same independent of the client and other intended user(s)?

Response: Before answering these questions, we first need to review portions of the SCOPE OF WORK RULE.

In any appraisal, appraisal review or appraisal consulting assignment, the appraiser must identify the problem to be solved, then determine and perform the scope of work necessary to develop credible assignment results in the context of the intended use. Appraisers have broad flexibility and significant responsibility in determining the appropriate scope of work for an assignment. It is the appraiser's responsibility, with input from the client, to identify the assignment elements. Assignment elements are the:

- client and any other intended users;
- intended use of the appraiser's opinions and conclusions;
- type and definition of value;
- effective date of the appraiser's opinions and conclusions;
- subject of the assignment and its relevant characteristics; and
- assignment conditions.

Assignment conditions include assumptions, extraordinary assumptions, hypothetical conditions, laws and regulations, jurisdictional exceptions and other conditions that affect scope of work.

The answer to each of the above questions is yes. Providing the other assignment elements (except the client) and the scope of work are the same, the appraiser's value opinion will be the same.

As an example, suppose an appraiser is requested to provide an opinion of the market value of a property for a specific intended use, such as for a potential sale or acquisition. Unless other assignment elements are different, and the appraiser establishes and follows a different scope of work as a result of differing assignment elements, there will be no difference in the value opinion regardless of whether the intended user is the buyer, seller, or a third party.

In all assignments, the appraiser must comply with the Management section of the ETHICS RULE, which prohibits compensation that is based on *a direction in assignment results that favors the cause of the client*. In all assignments, the appraiser must comply with the Conduct section of the ETHICS RULE which states, *an appraiser must perform assignments with impartiality, objectivity, and independence, and without accommodation of personal interests*. In addition, *an appraiser must not advocate the cause or interest of any party or issue*. If an appraiser's results vary solely depending on whether the client is a buyer or seller, the appraiser would be acting as an advocate for the cause of the client.

There are times, however, when assignments involving the same property will have different assignment elements. These could include different effective dates, types and definitions of value (market value, as opposed to insurable value, for example) or assignment conditions. As a result of a change in assignment elements, the value conclusion may be different; but the value conclusion will not differ simply because the client changed. The value conclusion differs because one or more of the other assignment elements changed; as a result, the appraiser established and followed a different scope of work.

151. OBLIGATION TO ANALYZE WITHDRAWN OR EXPIRED LISTINGS

Question: I was asked to appraise a single-family residence for refinancing. I am aware that the property had been previously listed but did not sell. During my data investigation and analysis, I noted that the owner’s estimate of value was \$375,000. When I looked up the listing history, I found it had been withdrawn from the market at the asking price of \$325,000. What are my obligations under USPAP regarding a withdrawn or expired listing of the subject property?

Response: Standards Rule 1-5(a) states:

When the value opinion to be developed is market value, an appraiser must, if such information is available to the appraiser in the normal course of business:

(a) analyze all agreements of sale, options, or listings of the subject property current as of the effective date of the appraisal.

Therefore, there is not a specific requirement in Standards Rule 1-5(a) to consider and analyze a withdrawn or expired listing of the subject property, prior to the date of the appraisal.

However, a listing of the subject property prior to the effective date of the appraisal might be significant in that it indicates the property’s availability in the market and the market reaction to that availability. Likewise, agreements of sale and options are generally significant to the appraisal problem in that they involve a meeting of the minds relating to the property’s value between the potential buyer and seller.

In the development of an appraisal, an appraiser is required under Standards Rule 1-1(b), to *not commit a substantial error of omission or commission that significantly affects an appraisal*. If information about a withdrawn or expired listing is known by the appraiser and that information is relevant to the appraisal problem, it must be considered.

152. HOW CREDIBLE ASSIGNMENT RESULTS ARE MEASURED

Question: What’s important to know about measuring credible assignment results?

Response: Whether or not assignment results are credible is always measured in the context of the intended use of the assignment. This means that credibility is relative, not absolute. Assignment results that are credible for one intended use may not be credible for another intended use.

153. ERRORS OF COMMISSION AND OMISSION

Question: A reviewer recently told me that my residential appraisal did not comply with USPAP because of errors of omission and commission and cited Standards Rule 1-1(b). What is the difference between these errors?

Response: An error of *commission* is doing something incorrectly. For example, to incorrectly identify the subject property’s relevant characteristics is an error of commission. In a residential appraisal assignment, this could be inaccurately measuring the property.

An error of *omission* is neglecting to do something that is necessary. For example, failing to identify the subject property's relevant characteristic is an error of omission. In a residential appraisal assignment, this could be neglecting to measure the second level of a two-story house.

154. MAKING A SERIES OF ERRORS

Question: A reviewer told me that my real property appraisal did not comply with USPAP because I made several minor calculation and analytical errors. Does USPAP address this issue?

Response: Yes. Standards Rule 1-1(c) addresses when small errors affect the credibility of the assignment results. For example, in a residential appraisal, making small errors in determining the property size, not recognizing minor deferred maintenance items, and making a small negative adjustment when it should have been a positive adjustment, could affect credibility.

An appraiser may not make a number of errors that, while not individually significant to the assignment results, would, when taken together, affect the credibility of those results.

155. CHANGING THE SCOPE OF WORK AFTER THE REPORT HAS BEEN SUBMITTED

Question: Sometimes after submitting my appraisal report, my client will ask me to perform additional work. This can mean looking at more or different comparables or developing another approach. Do these requests for additional work create a new assignment?

Response: No. Requests to perform additional research or analysis change the scope of work, but do not create a new assignment. The additional work can be performed as part of the original assignment. The appraiser may decide, as a business decision, to treat the request for additional research and analysis as a new assignment, but it is not required.

156. JUDGING THE ACTIONS OF AN APPRAISER'S PEERS

Question: In the SCOPE OF WORK RULE, one of the two tests regarding the acceptability of an appraiser's scope of work is what the appraiser's peers would do. There are many appraisers that do things differently, so how would I know what they would do in an assignment?

Response: The SCOPE OF WORK RULE states that the acceptability of an appraiser's work is judged based on two tests:

- the expectations of parties who are regularly intended users for similar assignments; and
- what an appraiser's peers' actions would be in performing the same or a similar assignment.

The first step in knowing what your peers would do is to identify your peers. In USPAP, the term appraiser's peers has a specific meaning. It is defined as:

other appraisers who have expertise and competency in a similar type of assignment.

This definition illustrates that an appraiser's peers are assignment specific and may change from assignment to assignment. This is because appraisers have varying levels of expertise and competency in specific property types, geographic locations, or other important areas of appraisal. For more information on appraiser's peers, please see Advisory Opinion 29, *An Acceptable Scope of Work*.

Knowledge about what an appraiser's peers would do in a similar assignment comes through being a participant in the profession. Typical forums that allow appraisal professionals to share information about practice include appraisal journals and publications, professional meetings and conferences, education through courses and seminars, and appraisal discussion groups.

157. TYPE AND DEFINITION OF VALUE, AND CITATION OF SOURCE

Question: USPAP requires appraisal reports to identify the type and definition of value and cite the source of the definition. What is the type of value? Why is this no longer referred to as the purpose of the assignment? What sources can be used to comply with the requirement to cite the source of the definition of value?

Response: STANDARDS 2, 6, 8 and 10 require that appraisal reports state the type and definition of value and cite the source of the definition. The exact wording varies by reporting option.

Previously, the term purpose in USPAP was used to refer to several different concepts, including the type and definition of value. For the 2005 edition of USPAP, this and other special meanings of this term were eliminated to increase clarity. Where it is now used in USPAP, purpose only conveys the standard dictionary meaning of the word.

The type of value is the general class or category of value. Examples include market value or fair value.

The definition of value provides a specific description of the characteristics and conditions of the type of value. Examples include definitions provided on a form report, in FIRREA, in U.S. accounting regulations, U.S. tax regulations, and various court rulings.

USPAP does not provide any specific definition of value or endorse any particular source; it merely defines the general components required to establish a market value definition. Sources of value definitions could include, for example, a regulatory agency, a legal jurisdiction, an engagement letter, or a textbook.

158. MARKET RENT OPINION

Question: I was asked by a client to provide an opinion of the market rent for a commercial property. Is such an assignment considered an appraisal?

Response: Yes. USPAP defines an appraisal as an opinion of value, and market rent is an expression of value for the right to use a property. Therefore, to comply with USPAP in this assignment, an appraiser would have to follow STANDARD 1 to develop the opinion of the market rent, and STANDARD 2 to report the assignment results.

159. USING THE DEFINITION OF VALUE PROVIDED

Question: A client has asked me to use a definition of value included in an engagement letter for the assignment. Is this permitted?

Response: Yes. As part of identifying the problem to be solved, the appraiser must identify the type and definition of value, but USPAP does not require the use of any specific type or definition of value.

For example, in a real property appraisal assignment Standards Rule 1-2(c) requires the appraiser to:

identify the type and definition of the value ...

In addition, Standards Rules 2-2 (a)(v) and 2-2 (b)(v) require that the report:

state the type and definition of value and cite the source of the definition;

Comment: Stating the definition of value also requires any comments needed to clearly indicate to intended users how the definition is being applied.

The source of the definition of value could be as simple as provided in the engagement letter.

The requirements for identifying and reporting the definition of value are similar for personal property and business and intangible asset appraisals.

160. SALES OR FINANCING CONCESSIONS

Question: The real estate market I appraise in has slowed down over the last 12 to 18 months, and it is now extremely common to see seller concessions as part of a purchase transaction. What are the USPAP requirements regarding proper treatment of sales/financing concessions?

Response: Sales or financing concessions may have an effect on the price paid for a property. As such, it is important for the appraiser to recognize this and analyze their impact. Sales or financing concessions should be considered in light of the type and definition of value used in an assignment. If the value opinion to be developed in a real property appraisal assignment is market value, then Standards Rule 1-2(c) requires the appraiser to ascertain whether the value is to be the most probable price:

- (i.) *in terms of cash; or*
- (ii.) *in terms of financial arrangements equivalent to cash; or*
- (iii.) *in other precisely defined terms; and*
- (iv.) ***if the opinion of value is to be based on non-market financing or financing with unusual conditions or incentives, the terms of such financing must be clearly identified and the appraiser's opinion of their contributions to or negative influence on value must be developed by analysis of relevant market data;*** (Bold added for emphasis.)

It should be noted that some assignment conditions, such as Fannie Mae appraisal guidelines, specify how sales or financing concessions are to be addressed in assignments that are subject to their guidelines. Appraisers performing assignments of this type should become familiar with all applicable guidelines in order to satisfy the requirements of the COMPETENCY RULE.

161. INTENTIONALLY DEFLATING OPINIONS OF VALUE

Question: Most appraisers know that inflating values is unethical, but some appraisers think that deflating values is acceptable, particularly in light of difficult market conditions. I think that both actions are unethical. Am I correct?

Response: Yes. The ETHICS RULE requires an appraiser to be independent, impartial, and objective, and to perform assignments without bias. An appraiser who intentionally inflates or deflates an opinion of value would be in violation of the Conduct section of that Rule.

162. MEASURING SINGLE FAMILY RESIDENCES USING THE ANSI STANDARD

Question: Are appraisers bound by USPAP required to comply with ANSI Z765-2003, the *Standards Method for Measuring Square Footage in Detached and Attached Single Family Houses*?

Response: No. Appraisers are not required by USPAP to comply with ANSI Z765-2003, which is a voluntary Standard. However, use of the ANSI Standards may be an assignment condition in some assignments.

Although appraisers are not required by USPAP to adhere to a specific standard of square footage measurement, appraisers are required by Standards Rule 1-1(b) to *not commit a substantial error of omission or commission that significantly affects an appraisal*. This rule requires the appraiser to gather factual information in a manner that is sufficiently diligent. Standards Rule 1-1(c) requires appraisers to *not render appraisal services in a careless or negligent manner*. Appraisers must use due diligence and due care in performing appraisal services, including gathering factual data such as square footage.

Copies of the ANSI Standards may be obtained from the National Association of Home Builders Research Center by telephoning (301) 249-4000, or by visiting their website at <http://www.nahbrc.com/bookstore/bd1003w.aspx>.

163. EXPOSURE TIME AND MARKETING TIME

Question: What is the difference between exposure time and marketing time?

Response: Both the DEFINITIONS and STATEMENT ON APPRAISAL STANDARDS NO. 6 (SMT-6), *Reasonable Exposure Time in Real Property and Personal Property Market Value Opinions of Value*, define exposure time as:

estimated length of time that the property interest being appraised would have been offered on the market prior to the hypothetical consummation of a sale at market value on the effective date of the appraisal.

Comment: Exposure time is a retrospective opinion based on an analysis of past events assuming a competitive and open market.

In contrast, Advisory Opinion 7 (AO-7), *Marketing Time Opinions*, defines marketing time as:
an opinion of the amount of time it might take to sell a real or personal property interest at the concluded market value level during the period immediately after the effective date of an appraisal.

In other words, exposure time occurs **before** the effective date of the appraisal, whereas marketing time occurs **after** the effective date. An estimate of exposure time is required by USPAP for market value appraisal assignments (see Standards Rules 1-2(c)(iv) and 7-2(c)(iv)), whereas an estimate of marketing time is not mandated by USPAP (but may be required by the client and so becomes an assignment condition in those assignments). For additional guidance, see SMT-6 and AO-7.

164. CHECKING STABLE VS. DECLINING PROPERTY VALUES

Question: When performing residential appraisal assignments I use standard preprinted appraisal software forms. The forms ask me to identify whether neighborhood property values are increasing, stable, or declining. I have been told that lenders won't accept appraisal reports where declining is checked (even when this is an accurate analysis), so I usually check stable to accommodate the underwriting process. Is this a violation of USPAP?

Response: Yes. If the appraiser is aware that a market is declining and either **intentionally or due to gross negligence**, reports it as being otherwise, he or she is in violation of the ETHICS RULE.

If an appraisal report indicates that property values are stable when they are actually declining and the appraiser's data supports the conclusion of declining values, the report is misleading and in violation of Standards Rule 2-1(a).

In addition, if the appraiser does not properly recognize that a market is declining, he or she may also be in violation of other requirements in STANDARD 1, as well as the COMPETENCY RULE.

165. RANGE OF VALUE

Question: Is a range of value considered an appraisal?

Response: Yes. The Comment to the definition of appraisal states:

An appraisal must be numerically expressed as a specific amount, as a range of numbers, or as a relationship (e.g., not more than, not less than) to a previous value opinion or numerical benchmark (e.g., assessed value, collateral value).

166. MORE THAN ONE INTENDED USE

Question: Can an appraisal, appraisal review, or appraisal consulting assignment include more than one intended use?

Response: Yes. USPAP requires appraisers to *identify the intended use of the appraiser's opinions and conclusions*. There is no prohibition against having more than one intended use. However, when performing an appraisal, appraisal review, or appraisal consulting assignment with multiple intended uses, the appraiser must be very careful to clearly identify each of the intended uses in the report to limit the possibility of confusion.

Additionally, the appraiser must comply with all assignment conditions that are applicable to the intended uses. The appraiser must also recognize that the scope of work may need to be expanded in order to provide credible results for all of the intended uses.

167. VALUE IN USE REQUEST FROM FEDERALLY REGULATED LENDER

Question: My client, a federally insured financial institution, has asked me to provide a value in use appraisal instead of a market value appraisal. May I do this?

Response: USPAP does not dictate the use of any specific type or definition of value. The type and definition of value must be appropriate for the intended use and intended users.

For federally related transactions, federally insured financial institutions require an opinion of market value, as defined by regulations. Therefore, if you provide a value in use, you may also have to provide a market value, depending on the intended use.

168. DRIVE-BY AND DESKTOP APPRAISALS

Question: Does USPAP permit real property appraisers to perform drive-by or desktop appraisal assignments?

Response: The Comment to Standards Rule 1-2(e) states:

An appraiser may use any combination of a property inspection and documents to identify the relevant characteristics of the subject property.

This is also discussed in Advisory Opinion 2 (AO-2), *Inspection of Subject Property*. It states:

An inspection is not required by USPAP, but one is often conducted.

The extent of the inspection process is an aspect of the scope of work, and may vary based on assignment conditions and the intended use of the assignment results. It is the appraiser's responsibility to determine the appropriate scope of work, including the degree of inspection necessary to produce credible assignment results given the intended use.

For further clarification, see AO-2.

169. INSPECTION OF SUBJECT PROPERTY

Question: Have I violated USPAP if I don't inspect the interior of the subject property?

Response: USPAP has no requirement to inspect a subject property's interior. Standards Rule 1-1(b) requires an appraiser to *not commit a substantial error of omission or commission that significantly affects an appraisal*. The Comment to that Standards Rule states, in part:

Diligence is required to identify and analyze the factors, conditions, data, and other information that would have a significant effect on the credibility of the assignment results.

Standards Rule 1-2(e)(i) requires that an appraiser identify a subject property's physical characteristics, and its legal and economic attributes. But, note that the required identification must be *relevant to the type and definition of value and intended use of the appraisal*. If an interior inspection is not relevant, it is not required. Determining whether an interior inspection is relevant is a scope of work decision; the SCOPE OF WORK RULE states:

An appraiser must not allow assignment conditions to limit the scope of work to such a degree that the assignment results are not credible in the context of the intended use.

Advisory Opinion 2, *Inspection of the Subject Property* advises that if adequate information about the relevant characteristics of the subject property, such as information that could only be obtained as a result of an interior inspection, is not possible by personal inspection or from sources the appraiser believes are reliable, an appraiser must withdraw from the assignment unless the appraiser can:

- *modify the assignment conditions to expand the scope of work to include gathering the necessary information; or*
- *use an extraordinary assumption about such information, if credible assignment results can still be developed*

Additional guidance about inspecting properties can be found in AO-23, *Identifying the Relevant Characteristics of the Subject Property of a Real Property Appraisal Assignment*, and AO-28, *Scope of Work Decision, Performance, and Disclosure*.

170. DOES INSPECTION OF SUBJECT PROPERTY MEAN A PHYSICAL INSPECTION?

Question: I am a licensed trainee with approximately six months of experience. My supervisory appraiser recently determined that I am competent to perform inspections on my own; however, many of our clients require the supervisory appraiser to physically inspect the property as well. If I do the inspection by myself, but take numerous representative photos of the interior of the subject property, may my supervisory appraiser indicate in the report that he also inspected the property?

Response: No. A physical inspection of the interior of the property is not the same as a physical inspection of photographs of the interior of the property. It would be misleading for any appraiser, including supervisory appraisers, to indicate that a physical inspection was performed when, in fact, the appraiser viewed photographs of the property. An appraiser who only inspects photographs of a property, but signs a certification indicating that he or she physically inspected the subject property, is in violation of the USPAP prohibition against communicating assignment results with the intent to mislead or to defraud, communicating a report that is known by the appraiser to be misleading or fraudulent, and, possibly, knowingly permitting an employee or other person to communicate a misleading or fraudulent report. (See Conduct section of the ETHICS RULE.)

171. IS IT PERMISSIBLE TO USE MLS PHOTOS FOR COMPARABLE SALES?

Question: I use standard pre-printed appraisal report forms that contain a statement saying I personally inspected the exterior of the comparable sales. The assignment conditions require me to comply with this statement and do not permit any alterations. One of my clients now requires two additional sales of comparable properties to be included with every appraisal report. However, the client told me not to inspect the exterior of these additional sale comparables and to just use the MLS photos. May I comply with the client's request?

Response: No; you are being asked to not inspect the comparable sales when the form states that you have. You must either inspect the sales or change your report to indicate you did not inspect the sales.

172. IS IT PERMISSIBLE TO USE MLS PHOTOS FOR ACTIVE LISTINGS?

Question: I use a pre-printed appraisal report form that contains a statement saying I personally inspected the exterior of the comparable sales, but it does not address active listings. One of my clients now requires two additional active listing comparable properties to be included with every appraisal report. However, the client told me not to inspect the exterior of these active listings and to just use the MLS photos. Am I compliant with USPAP if I do not physically inspect the exterior of these properties and only use the MLS photos?

Response: Yes; USPAP does not require physical inspections or photographs. However, both are often required by clients. If an inspection of the active listing comparables is not required for credible assignment results, and it is not contrary to assignment conditions or specific statements in the report, then using an MLS photo and not performing an exterior inspection would be acceptable.

173. COST APPROACH NOT NECESSARY FOR APPRAISAL OF VACANT LAND

Question: The property I am appraising is land without improvements, to be valued as is without foreseeable change in zoning or use. Does Standards Rule 1-4(b)(i) mean that I must complete a cost approach for my market value opinion to be credible?

Response: No. In the assignment you describe, the land is the subject of the appraisal. Since there are no improvements and testing the economic feasibility of a change in use is not part of the appraisal problem, a cost approach is not necessary in this assignment. The methods and techniques that are necessary in solving the appraisal problem will depend on the type and definition of value and intended use of the appraisal, and on the relevant characteristics of the property.

As required by Standards Rule 1-1(a), *an appraiser must be aware of, understand, and correctly employ those recognized methods and techniques that are necessary to produce a credible appraisal.*

An appraiser's decision about which methods and techniques are necessary to solve the appraisal problem is largely shaped by the information gathered in response to Standards Rule 1-2(e), which requires an appraiser to *identify the characteristics of the property that are relevant to the type and definition of value and intended use of the appraisal.*

If the value opinion to be developed is market value, and when necessary for credible assignment results, Standards Rule 1-3 requires an appraiser to identify and analyze the effect on use and value of existing land use regulations, reasonably probable modifications of such land use regulations, economic supply and demand, the physical adaptability of the real estate, and market area trends, and develop an opinion of the highest and best use of the real estate.

Having completed the actions required by Standards Rule 1-2 and, when applicable, Standards Rule 1-3, an appraiser can reasonably determine which methods and techniques are necessary in solving the appraisal problem. While there are exceptions, land without improvements is often appraised by using the sales comparison approach or income approach, or both.

174. COST APPROACH AND FANNIE MAE FORM 1004/FREDDIE MAC FORM 70

Question: The November 2005 revision of Fannie Mae Form 1004/Freddie Mac Form 70 indicates that completion of the cost approach is not required for Fannie Mae or Freddie Mac. Is it acceptable to simply omit the cost approach when using this appraisal report form?

Response: The appraisal report form on which an appraisal is reported does not dictate the scope of work performed. The appraiser must identify the appraisal problem and determine the proper scope of work.

If the cost approach is required for credible assignment results, then it must be developed and the results must be included in the appraisal report. If the cost approach is not required for credible assignment results, the appraiser may elect not to complete the cost approach. If it is omitted, the report must explain the omission.

Whether or not the cost approach is necessary is a decision that must be made by the appraiser based on the intended use, intended user, and other assignment elements.

175. APPRAISING IMPROVED LAND

Question: I am appraising a property improved with an apartment complex, but have found that the land is zoned for commercial use. My research indicates that such commercial land would have a value different from that of apartment land, but still far less than the current total value of the apartment complex. According to USPAP, how should I value the land?

Response: USPAP does not dictate the use of any particular theory or technique. You may apply any method, as long as it is recognized, applicable, and correctly employed. SR 1-1(a) only requires the appraiser to *correctly employ those recognized methods and techniques that are necessary to produce a credible appraisal.*

176. IMPROVEMENT ONLY APPRAISAL

Question: In a real property appraisal is it permissible to appraise only the improvements?

Response: Yes. Standards Rule 1-2(e)(v) states that the subject of an assignment may be a physical segment of a property.

The subject of a real property appraisal is not required to include all of the physical parts of an identified parcel or tract of real estate. The subject of a real property appraisal can be all or any part of an improved or unimproved parcel or tract of identified real estate. For example, the subject of a real property appraisal could be a part of the land, the improvements on or to the land, or some other configuration within a parcel or tract of identified real estate.

Use of a hypothetical condition or extraordinary assumption is not necessary in the specific case of appraising the building component of an improved property, although one or both may be necessary in other specific cases. However, to avoid communicating a misleading appraisal report, the report would have to disclose the existence of the land as part of the property, but the land does not have to be included in the valuation.

177. APPRAISING ONLY THE UNDERLYING LAND OF AN IMPROVED PROPERTY

Question: I have been asked by a local bank to appraise just the underlying land of an existing shopping center. Can I perform such an assignment under USPAP? If the answer is yes, would this require the use of a hypothetical condition?

Response: Yes; you can perform this type of assignment in compliance with USPAP. The subject of a real property appraisal is not limited to all of the physical parts of an identified parcel or tract of real estate. The subject of a real property appraisal can be a full or fractional ownership interest in all or any part of an improved or unimproved parcel or tract of identified real estate. For example, the subject of a real property appraisal could be a half-interest in the land, part of the land, the improvements on or to the land, or some other configuration within a parcel or tract of identified real estate.

Standards Rule 1-2(e) states, in part, the appraiser must:

identify the characteristics of the property that are relevant to the type and definition of value and intended use of the appraisal, including:

- (i) its location and physical, legal, and economic attributes;*
- (v) whether the subject property is a fractional interest, physical segment, or partial holding.*

In addition, the Comment to this Rule states, in part:

An appraiser is not required to value the whole when the subject of the appraisal is a fractional interest, a physical segment, or a partial holding.

Use of a hypothetical condition or extraordinary assumption is not necessary in the specific case of appraising the land component of an improved property, although one or both may be necessary in other specific cases. However, to avoid communicating a misleading appraisal report, the report would have to disclose the *existence* of the improvements as part of the property, but the improvements do not have to be included in the valuation.

178. APPRAISING PHYSICAL SEGMENTS (5-ACRE PORTION)

Question: A local lender has asked me to appraise only a 5-acre portion of a 62-acre parcel. Am I permitted to comply with this request?

Response: Standards Rule 1-2(e)(v) states that the subject of an assignment may be a physical segment of a property. However, appraisers must also comply with any laws, regulations, guidelines or other assignment conditions that might apply.

If the assignment requires compliance with published assignment conditions, the appraiser must be aware of the current guidelines (or regulations, if applicable).

Failure to recognize applicable assignment conditions would be a violation of the ETHICS RULE or COMPETENCY RULE.

179. INCOME AND EXPENSE ANALYSES

Question: I was asked by a client to prepare a five-year market-based forecast of income and expenses for a specific commercial property. Is such a request an appraisal assignment or an appraisal consulting assignment?

Response: The request is an appraisal consulting assignment, which includes an appraisal. The market-based income and expense forecast is an *analysis* by the appraiser that includes an opinion of market rent, which is an opinion of value. The process of developing an opinion of market rent *to be used* in the analysis is an appraisal, since USPAP defines an appraisal as an opinion of value. Therefore, to comply with USPAP an appraiser would have to follow STANDARD 1 to develop the opinion of the market rent (value), and STANDARD 4 to develop the income and expense analysis. The appraisal consulting report would have to comply with STANDARD 5.

180. PROPOSED IMPROVEMENTS – PLANS AND SPECIFICATIONS REQUIRED

Question: I have been asked to perform an appraisal involving proposed improvements. The client has indicated that plans and specs have not been finalized. Does USPAP require me to review the plans and specifications prior to completing this assignment?

Response: No. The Comment to the Standards Rule 1-2(e)(v) states, in part:

When appraising proposed improvements, an appraiser must examine and have available for future examination, plans, specifications, or other documentation sufficient to identify the extent and character of the proposed improvements. (Bold added for emphasis)

Hence, the appraisal can be based on other documentation if that documentation provides sufficient information to properly identify the relevant characteristics of the subject property.

Additional guidance on appraising proposed improvements can be found in Advisory Opinion 17, *Appraisals of Real Property with Proposed Improvements*.

181. IS AN AVM AN APPRAISAL?

Question: Are the results from an Automated Valuation Model (AVM) an appraisal?

Response: No. Advisory Opinion 18, *Use of an Automated Valuation Model (AVM)*, states:

An AVM's output is not, by itself, an appraisal, and communication of an AVM's output is not, in itself, an appraisal report.

An AVM is a tool that delivers an estimation or calculation, whereas an appraiser arrives at a value opinion by applying his or her judgment and experience. An appraisal is defined as an opinion of value, which is distinctly different from an estimate or calculation of value. An AVM uses automated processes and cannot produce an opinion of value because only individuals can exercise judgment and form opinions. An AVM is just one tool among many that an appraiser might use to arrive at an opinion of value.

Appraisers are cautioned that this response is based on the USPAP definition of appraisal. Jurisdictions that use a different definition of appraisal may reach a different conclusion.

182. APPRAISER’S USPAP OBLIGATIONS WHEN USING AN AVM

Question: What are an appraiser’s USPAP obligations when using an Automated Valuation Model (AVM)?

Response: Many appraisers use calculators, spreadsheets, analytic software, and similar tools to analyze market data and calculate assignment results. The nature of the appraiser’s service and how these tools are used are important factors in recognizing USPAP obligations. When appraisers use an AVM it can be as part of an appraisal assignment that provides value opinions to the client, or it may be for an assignment to run the AVM and provide the output to the client.

Advisory Opinion 18, *Use of an Automated Valuation Model (AVM)*, provides advice to help appraisers properly distinguish among the uses of an AVM.

An appraiser who uses an AVM for any purpose is subject to the requirements of USPAP that apply to all appraisal practice: the DEFINITIONS, the PREAMBLE, the ETHICS RULE, the COMPETENCY RULE, and the JURISDICTIONAL EXCEPTION RULE.

When the assignment includes providing an opinion of value for real property, the assignment is an appraisal and the RECORD KEEPING RULE, the SCOPE OF WORK RULE, and STANDARDS 1 and 2 also apply.

183. UNIFORM ACT AND SCOPE OF WORK

I’m doing an appraisal assignment for a government agency that is subject to the jurisdiction of The Uniform Relocation Assistance and Real Property Acquisitions Act of 1970, as Amended (commonly known as, the Uniform Act), and its implementing regulation, 49 CFR Part 24. The regulation requires the acquiring agency to develop the scope of work and define the appraisal problem cooperatively with the appraiser. This is somewhat different from USPAP’s SCOPE OF WORK RULE which places that responsibility primarily on the appraiser. The agency is providing a draft scope of work and asking me to comply with that as a minimum assignment condition. This raises two possible scenarios.

Question: (1) If the agency scope of work seems appropriate, do I need to state somewhere in my report that the scope of work was developed by the agency with my concurrence?

(2.) Assume that I believe the agency scope of work is inappropriate or inadequate. I discuss this with the agency and they insist that the scope of work they have developed is appropriate for their program needs. Can I complete the assignment and be in USPAP compliance?

Response: The answer to both questions is the same. It is the appraiser’s responsibility to determine and perform the appropriate scope of work.

The scope of work performed in the assignment must be disclosed in the report. However, USPAP does not address disclosure of the client’s role in determining the scope of work.

Direction from the client on the scope of work is acceptable only if the appraiser is able to develop credible assignment results. If the scope of work specified by the client does not allow the development of credible assignment results, the appraiser must either (a) obtain the client’s agreement for an appropriate scope of work, or (b) withdraw from the assignment.

184. APPRAISING LARGE GROUPS OF SIMILAR OR LIKE ITEMS

Question: When an appraiser is asked to value a significantly large group of similar or like items does USPAP require that the appraiser follow STANDARD 6 for mass appraisals?

Response: No. USPAP does not require that STANDARD 6 be followed in such cases. Mass appraisal, for which performance standards are addressed in STANDARD 6, is an appraisal method. USPAP does not dictate the use of any particular method or technique in any particular assignment or under any particular set of circumstances. While mass appraisal methods may be helpful in the appraisal of large numbers of similar assets, whether its use is appropriate in a particular assignment would depend on such things as assignment conditions, the intended use of the appraisal results, and, at times, agreement with the client.

185. BLOCKAGE DISCOUNT AND STANDARD 6

Question: Is there any connection between the application of STANDARD 6 for mass appraisals and the application of a blockage discount?

Response: No. There is no connection between the application of mass appraisal methods, as addressed in STANDARD 6, and the application of a blockage discount. A blockage discount may be applicable when the appraisal problem being addressed indicates an assumption that a large number of similar assets would be offered for sale on the market at once. Under some circumstances, this would create an oversupply, which would depress the value of the assets.

Whether the application of a blockage discount is appropriate depends on many factors, including the intended use of the appraisal, the type and definition of value, the conditions of the assignment, and the relevant characteristics of the assets. Relevant characteristics include the nature of the assets, their market and other factors.

186. CALCULATING BLOCKAGE DISCOUNT

Question: Does USPAP offer guidance in how to calculate an appropriate blockage discount?

Response: No. USPAP focuses on appraisal standards, not appraisal methodology or how to perform calculations. USPAP does require that an appraiser be competent (see the COMPETENCY RULE) and states, in Standards Rule 1-1(a) and the other development Standards, that an appraiser must:

be aware of, understand, and correctly employ those recognized methods and techniques that are necessary to produce a credible appraisal.

The concept of the compilation of the assets appraised is addressed, for example, in Standards Rule 1-4(e), which states:

When analyzing the assemblage of the various estates or component parts of a property, an appraiser must analyze the effect on value, if any, of the assemblage. An appraiser must refrain from valuing the whole solely by adding together the individual values of the various estates or component parts.

Standards Rule 6-2(g)(i) states that, in appraising real property or personal property, an appraiser must *identify the appropriate market area and time frame relative to the property being valued*. Standards Rule 6-2(g)(v) requires that the appraiser *identify and analyze whether an appraised*

fractional interest, physical segment, or partial holding contributes pro rata to the value of the whole. Standards Rule 6-2(h) requires that an appraiser analyze the relevant economic conditions at the time of the valuation, including market acceptability of the property and supply, demand, scarcity, or rarity.

187. BUSINESS VALUATION USING ASSET-BASED (COST) APPROACH

Question: I am valuing a controlling interest in a business enterprise by use of an asset-based (cost) approach, and that business owns real property. Am I required to have an appraisal of the real property or may I use other indications of the real property value?

Response: An appraisal of the real property would not always be required. Whether or not an appraisal is necessary is based on whether credible assignment results can be developed for the business interest without such an appraisal, and whether or not assignment results are credible is measured in the context of the intended use of those assignment results. The decision is part of the scope of work determination the business appraiser must make.

For some intended uses, a business appraiser may determine that a real property appraisal, performed by an appraiser competent to perform the appraisal in compliance with USPAP, is required. For other intended uses, the business appraiser may determine that an indication of the real property value other than a real property appraisal may be appropriate. Such indications could be a management estimate, a recent transaction of the property, or tax assessment values.

188. ALLOCATION OF VALUE OPINIONS

I often perform real property appraisal assignments that include not only real property but also personal property and/or intangible items (examples include property types such as hotels and restaurants).

Often times, my clients will request that I separate or allocate a portion of the defined value opinion to these non-real property components. These requests raise the following four questions.

Question: (1.) What exactly are the appraiser's USPAP obligations in performing this separation of value?

Question: (2.) May this allocation be accomplished without the appraiser developing an opinion of value in compliance with STANDARD 7 or 9?

Question: (3.) Is an allocation considered to be synonymous with an opinion of value or is it the result of a mathematical calculation?

Question: (4.) There are also occasions when the client does not specifically request separate valuations of non-real property assets, even though they may be present. Is the appraiser still required to value those assets separately?

Response: Standards Rule 1-2(e) requires an appraiser to:

Identify the characteristics of the property that are relevant to the type and definition of value and intended use of the appraisal, including:

(iii) any personal property, trade fixtures, or intangible items that are not real property but are included in the appraisal; ...

Standards Rule 1-4(g) states:

When personal property, trade fixtures, or intangible items are included in the appraisal, the appraiser must analyze the effect on value of such non-real property items.

And the Comment to SR 1-4(g) further states:

When the scope of work includes an appraisal of personal property, trade fixtures or intangible items, competency in personal property appraisal (see STANDARD 7) or business appraisal (see STANDARD 9) is required.

Given this background, each of the questions can be answered as follows.

Question: (1) **What exactly are the appraiser’s USPAP obligations in performing this separation of value?**

Response: Whether this is labeled a separation or an allocation, it is an appraisal as defined in USPAP.

Question: (2) **May this allocation be accomplished without the appraiser developing an opinion of value in compliance with STANDARD 7 or 9?**

Response: No. Once it is understood that performing this separation of value is synonymous with performing this appraisal, compliance with the applicable Standards Rules is required, as is appropriate competency.

Question: (3) **Is an allocation considered to be synonymous with an opinion of value or is it the result of a mathematical calculation?**

Response: As stated in the response to Question #1, an allocation is synonymous with an appraisal.

Question: (4) **There are also occasions when the client does not specifically request separate valuations of non-real property assets, even though they may be present. Is the appraiser still required to value those assets separately?**

Response: No. This is a scope of work decision to be made by the appraiser; Standards Rule 1-4(g) does not require separate appraisals of these different types of assets. SR 1-4 (g) states:

When personal property, trade fixtures, or intangible items are included in the appraisal, the appraiser must analyze the effect on value of such non-real property items.

Comment: When the scope of work includes an appraisal of personal property, trade fixtures or intangible items, competency in personal property appraisal (see STANDARD 7) or business appraisal (see STANDARD 9) is required.

Some appraisers and users of appraisals believe the requirement that *the appraiser must analyze the effect on value of such non-real property items* in SR 1-4(g) is a requirement for the separate

appraisal of those items in all assignments. That is incorrect. Analyzing the effect on value might be appropriately made through the selection of comparable properties used in the sales comparison approach or the deduction of certain line items of expense for management fees, maintenance or replacements in the income approach, for example.

189. LEASED FEE INTEREST WHEN INTANGIBLE ASSETS EXIST

Question: I am appraising a single tenant retail property that is being sold with financing by my client, which is a bank. The property was developed by XYZ Company and just completed last month for a total development cost (land and improvements) of \$1,500,000. The developer is part of a large retail chain that will occupy the building at an above-market lease rate. The property is being sold to an investor on a sale-leaseback basis for over \$2,000,000. This sale price is supported by several other sales that also have above-market leases that were also created by the same type of sale-leaseback arrangements.

When I questioned the seller/tenant’s representative, they said that *both parties recognized the lease rate was above-market* and that the price was well above replacement cost. They noted that the lease supported the sale price and that the credit strength of the XYZ Company warranted using the above-market lease rate for the valuation. Should I allocate the portion of above-market rent to the real estate or treat it as an intangible? My client insists that I attribute the entire rent to real property value. What does USPAP require in this situation?

Response: The subject of this appraisal is real property, not intangibles, specifically the leased fee estate; therefore, Standards Rule 1-2(e) applies. The characteristics of the lease must be identified in accordance with Standards Rule 1-2(e)(iv). In developing a real property appraisal, Standards Rule 1-2(e) states an appraiser must:

identify the characteristics of the property that are relevant to the type and definition of value and intended use of the appraisal, including:

- (i) its location and physical, legal, and economic attributes;*
- (ii) **the real property interest to be valued;***
- (iii) any personal property, trade fixtures, or intangible items that are not real property but are included in the appraisal;*
- (iv) **any known** easements, restrictions, encumbrances, **leases**, reservations, covenants, **contracts**, declarations, special assessments, ordinances, or other items of a similar nature; and*
- (v) whether the subject property is a fractional interest, physical segment, or partial holding. (Bold added for emphasis)*

Further, the valuation in this assignment must address the effect of the lease on value in accordance with Standards Rule 1-4(d) that states:

When developing an opinion of the value of a leased fee estate or a leasehold estate, an appraiser must analyze the effect on value, if any, of the terms and conditions of the lease(s).

In this situation you are required to analyze the effect on value of the above-market lease. The result of the analyses must be reported in accordance with Standards Rule 2-2, for example 2-2(b)(viii) which states, in part:

summarize the information analyzed, the appraisal methods and techniques employed, and the reasoning that supports the analyses, opinions, and conclusions; ...

190. PURCHASE CONTRACT IS NOT PROVIDED TO THE APPRAISER

Question: I was recently engaged to conduct a market value appraisal of a one-to-four unit residential property. The intended use of this appraisal is to assist the client in analyzing the loan collateral associated with the property's purchase. I requested a copy of the purchase contract from the client, but they refused to provide it although they acknowledged that a contract for purchase of the property in fee simple exists. They did, however, provide a sale price orally. Can I continue this assignment, without the purchase contract, and comply with USPAP?

Response: Yes. You can complete the assignment in compliance with USPAP; however, you will need to ensure compliance with Standards Rule 1-5(a) in developing the appraisal, and with Standards Rule 2-2(a)(viii), (b)(viii), or (c)(viii), as applicable to the type of appraisal report determined most appropriate, given the intended users, in reporting the assignment results.

Standards Rule 1-5(a) states:

When the value opinion to be developed is market value, an appraiser must, if such information is available to the appraiser in the normal course of business:

(a) analyze all agreements of sale, options, or listings of the subject property current as of the effective date of the appraisal;

The Comment to Standards Rule 1-5 states:

See the Comments to Standards Rules 2-2(a)(viii), 2-2(b)(viii), and 2-2(c)(viii) for corresponding reporting requirements relating to the availability and relevance of information.

For example, the corresponding reporting requirements in Standards Rule 2-2(a)(viii), in the Comment, are, in part:

If such information is unobtainable, a statement on the efforts undertaken by the appraiser to obtain the information is required.

The appraiser has an obligation to make an effort to obtain a copy of the purchase contract and the report must state what efforts were made. In addition, if a copy of the contract cannot be obtained, the appraiser must perform the analysis and report the results of the analysis based on the information provided. In order to avoid being misleading, the report must disclose the source of the contract information.

Complying with these Standards Rules ensures that the existence and unavailability of the purchase contract is appropriately disclosed, and intended users will not be misled as to how this situation was handled in the analysis and report.

191. AVAILABILITY OF CURRENT AGREEMENT OF SALE

Question: When developing a real property appraisal, what is an appraiser’s responsibility under USPAP if a lender refuses to provide a copy of the current agreement of sale of the subject property?

Response: Standards Rule 1-5(a) requires an appraiser developing a real property appraisal, if such information is available to the appraiser in the normal course of business, to:

analyze all agreements of sale, options, or listings of the subject property current as of the effective date of the appraisal.

The normal course of business for an appraiser when the property is known to be the subject of a pending transaction is to ask the client for the terms of the agreement. If this request is denied, then the appraiser should make reasonable attempts to obtain this information from other sources through legal means commonly available to and practiced by the appraiser’s peers. Standards Rule 2-2(a)(viii), (b)(viii), or (c)(viii) also includes the requirement that:

If such information is unobtainable, a statement on the efforts undertaken by the appraiser to obtain the information is required. If such information is irrelevant, a statement acknowledging the existence of the information and citing its lack of relevance is required.

Refer to Standards Rules 2-2(a)(viii), (b)(viii), or (c)(viii) for related reporting requirements, and to Advisory Opinion 1, *Sales History* for additional information.

192. RECONCILIATION OF THE APPROACHES TO VALUE

Question: For a real property appraisal, I know that USPAP requires an appraiser to develop a reconciliation of the approaches to value that are used in an assignment. Does USPAP require the appraiser to reconcile the data utilized within each approach to value?

Response: Yes. Standards Rule 1-6 states:

In developing a real property appraisal, an appraiser must:

- (a) reconcile the quality and quantity of the data available **and analyzed within the approaches used**; and*
- (b) reconcile the applicability and relevance of the approaches, methods and techniques used to arrive at the value conclusion(s). (Bold added for emphasis.)*

193. ADJUSTMENTS IN SALES COMPARISON APPROACH

Question: Does USPAP place any limitation on the size of adjustments made to comparable sales in the sales comparison approach to value?

Response: No. USPAP places no limitations on the size of adjustments made in the sales comparison approach. However, it should be noted that certain clients and other intended users may have assignment conditions addressing this.

194. UPDATING A PRIOR ASSIGNMENT WITH A DIFFERENT SCOPE OF WORK

Question: Several months ago I appraised a property using only a sales comparison approach. My client is now asking that I perform an update of my prior appraisal, but they now want me to include a cost approach. Does USPAP allow me to do this?

Response: Yes. Update is a business term; under USPAP, the second assignment from the same client is a new assignment with its own scope of work and the requirement to produce credible assignment results. Advisory Opinion 3, *Update of a Prior Appraisal*, states, in part:

When developing an opinion regarding a property that was the subject of a previous assignment, the scope of work in the **new assignment** may be different from the scope of work in the prior one. (*Bold added for emphasis*)

Therefore, the new assignment can be performed with a scope of work greater than that performed in the original assignment.

195. APPRAISAL UPDATE WITH NO CHANGE IN VALUE

Question: I was recently contacted by a client for whom I had previously completed an appraisal. The client asked if I could simply tell them whether there have been changes in the market, or not, since the time of my appraisal, and that the value of the property remains the same. Am I permitted to do this under USPAP?

Response: Yes. However, it must also be understood that an appraiser making a determination that the value of a property has not changed is performing an appraisal as defined in USPAP. The Comment to the USPAP definition of appraisal states:

An appraisal must be numerically expressed as a specific amount, as a range of numbers, or as a relationship (e.g., not more than, not less than) to a previous value opinion or numerical benchmark (e.g., assessed value, collateral value). (Bold added for emphasis.)

In addition, the appraiser is obligated to comply with the reporting requirements of USPAP. The request from the client should be treated as a new assignment, which could be completed in accordance with Advisory Opinion 3, *Update of a Prior Appraisal*.

196. UPDATE OF AN APPRAISAL COMPLETED BY ANOTHER APPRAISER

Question: I was recently asked to update an appraisal performed by another appraiser who works for a different appraisal company. Can I prepare an update if the original appraisal was performed by another appraiser?

Response: Yes. Advisory Opinion 3, *Update to a Prior Appraisal*, provides advice on how such an assignment can be performed in conformance with USPAP.

197. DOES A NEW ASSIGNMENT REQUIRE STARTING OVER?

Question: **Advisory Opinion 26 (AO-26) and Advisory Opinion 27 (AO-27) clarify that I cannot readdress an appraisal, and I must treat a subsequent request as a new assignment. Does that mean I must start from scratch since I would be performing a new assignment for a different client? Must I re-inspect the property?**

Response: A new assignment does not mean that you must start from scratch. You must decide the appropriate scope of work for the new assignment. This would include a decision as to whether or not it is necessary to perform another inspection. The scope of work for the new assignment can be different from the scope of work completed in the earlier assignment.

As with any assignment, you might be able to use information and analyses developed for a previous assignment. Appraisers are often selected for subsequent assignments specifically because of experience and demonstrated competency in a prior assignment.

One must be mindful of obligations relating to the use of confidential information. The Confidentiality section of the ETHICS RULE states:

An appraiser must not disclose confidential information or assignment results prepared for a client to anyone other than the client and persons specifically authorized by the client...

198. RECERTIFICATION OF VALUE

Question: **I heard that a recertification of value is no longer permitted. Is this true?**

Response: No. This is not true; however, there is confusion surrounding this question because the term recertification of value is often mistakenly used by some clients in place of the term update.

Appraisers may perform a recertification of value to confirm whether or not the conditions of a prior appraisal have been met. However, if a client wants to know whether the value of a property has changed (or remained the same) since a prior appraisal, this is an update.

Regardless of the label used, an appraisal of a property that was the subject of a prior assignment is not an extension of the prior assignment – it is a new appraisal assignment. Information about an appraiser’s obligations in this situation can be found in Advisory Opinion 3, *Update of a Prior Appraisal*.

199. RECERTIFICATION OF VALUE AND APPRAISAL UPDATE

Question: **The terms recertification of value and appraisal update are often used interchangeably. Do they have the same meaning?**

Response: No; these terms do not have the same meaning. The terms update and recertification of value are discussed in Advisory Opinion 3 (AO-3), *Update of a Prior Appraisal*.

An update is a new appraisal assignment involving a property that was previously appraised. An update is subject to the same USPAP requirements as any other appraisal assignment.

A recertification of value is performed to confirm whether or not the conditions of a prior assignment have been met. One example of a recertification of value is a final inspection. When an

appraiser is asked to complete a final inspection, the appraiser is confirming that conditions established in an assignment have, or have not, been met.

Final inspections are commonly used in the case of proposed construction where an appraisal is completed subject to completion per plans and specifications.

Consult AO-3 for additional information.

200. APPRAISERS PROVIDING COMPS

Question: I have a client that just wants me to provide comps from a neighborhood. Are there any USPAP requirements I must comply with to perform this task?

Response: To answer this question, it is important to identify exactly what the appraiser is being asked to do. If the appraiser is asked to provide comps that would typically mean the appraiser would be exercising his or her own judgment to determine which sales are most comparable to the subject property. The appraiser may choose to include only those sales that he or she deems are most similar to the subject in size, location, quality, or other relevant characteristics, which could mean that certain sales may be omitted. In this case, the resulting data would have been filtered by the appraiser's judgment, which would have the net effect of providing a range of value to the client. This range of value is defined as an appraisal under USPAP; therefore, the appraiser would be obligated to comply with STANDARDS 1 and 2.

This should be contrasted to a request for an appraiser to simply provide data. For example, an appraiser asked by a client to provide sales data of all homes located within a one mile radius of a specific address could comply with the client's request without complying with STANDARDS 1 and 2, as the appraiser would just be providing sales data pursuant to the client's defined parameters. In this example, the appraiser must be careful not to communicate any opinions or conclusions regarding the data provided.

For related guidance on this topic, please refer to Advisory Opinion 19, *Unacceptable Assignment Conditions in Real Property Appraisal Assignments*.

201. CAN APPRAISERS PERFORM COMP CHECK ASSIGNMENTS?

Question: I'm a residential appraiser and have been asked to perform a comp check (or pre-comp) assignment, where a client wants to get an idea of the value of a home prior to proceeding with a mortgage financing transaction. Does USPAP allow me to perform this type of assignment?

Response: Yes. As stated in FAQ #200 these types of assignments are allowed under USPAP. To understand the USPAP requirements, it is important to identify exactly what the appraiser is being asked to do. If the appraiser is asked to provide comps, that would typically mean the appraiser would be exercising his or her own judgment to determine which sales are most comparable to the subject property. The appraiser may choose to include only those sales that he or she deems are most similar to the subject in size, location, quality, or other characteristics, which could mean that certain sales may be omitted. In this case, the resulting data would have been filtered by the appraiser's judgment, which would have the net effect of providing a range of value to the client. This range of value is defined as an appraisal under USPAP; therefore, the appraiser would be obligated to comply with STANDARDS 1 and 2.

But as FAQ #200 also states, comp check assignments should be contrasted to requests for an appraiser to simply provide data. For example, an appraiser asked by a client to provide sales data of all homes located within a one mile radius of a specific address could comply with the client's request without complying with STANDARDS 1 and 2, because the appraiser would just be providing sales data pursuant to the client's defined parameters. In this example, the appraiser must be careful not to communicate any opinions or conclusions regarding the data provided.

For additional related guidance on this topic, please refer to Advisory Opinion 19, *Unacceptable Assignment Conditions in Real Property Appraisal Assignments*.

202. SUDDEN MARKET CHANGES RELATED TO CATASTROPHIC EVENTS

Question: I live and work just outside an area that was devastated by a catastrophic weather event. My market area experienced sudden changes in supply and demand, and real estate sales prices climbed rapidly for a period of time following the disaster. Does USPAP provide advice to real estate appraisers on how to handle sudden market changes brought about by such catastrophic events?

Response: Although USPAP does not directly address the appraisal issues associated with catastrophic events, the following passages may be especially important in appraisals involving properties in markets that are changing rapidly, for any reason.

Standards Rule 1-2(e) requires an appraiser to identify economic attributes relevant to the subject property. Standards Rule 1-3(a) specifically requires analysis of supply and demand.

For Self-Contained and Summary Appraisal Reports, USPAP requires disclosure of *economic property characteristics relevant to the assignment*. Market conditions (including sudden market changes related to catastrophic events) are economic property characteristics, and, as such, should be identified in the development of an appraisal and disclosed in the appraisal report.

Standards Rules 2-2(a)(v) and 2-2(b)(v) address the type and definition of value used in an assignment. The Comments to these Standards Rules state, in part:

Stating the definition of value also requires any comments needed to clearly indicate to intended users how the definition is being applied.

In cases of sudden market change, it would be necessary to specifically disclose such things as how the appraisal has addressed the motivation of buyers and sellers, supply and demand, the conditions of the sale (e.g. exposure in a competitive market), and other important related influences on the property.

As noted in STANDARD 2, the content of all real property appraisal reports, *...must be consistent with the intended use of the appraisal*. In the case of a rapidly changing market, the report must have enough information to allow intended users to understand the market conditions and to use that information in their decision making.

203. CITING THE SOURCE OF THE VALUE DEFINITION AND FANNIE MAE FORM 1004/FREDDIE MAC FORM 70

Question: USPAP requires an appraisal report to include a citation of the source of the value definition used for the appraisal. Is this information adequately addressed on March 2005 version of Fannie Mae Form 1004/Freddie Mac Form 70?

Response: Yes. The value definition is pre-printed on the March 2005 version of Fannie Mae Form 1004/Freddie Mac Form 70, and there are several references indicating that Fannie Mae and Freddie Mac are the sources for the form. No additional citation is required for USPAP compliance.

APPRAISAL DEVELOPMENT – EXTRAORDINARY ASSUMPTIONS AND HYPOTHETICAL CONDITIONS

204. EXTRAORDINARY ASSUMPTIONS COMPARED TO HYPOTHETICAL CONDITIONS

Question: How does an extraordinary assumption differ from a hypothetical condition? Can you give some examples of extraordinary assumptions that might apply in a real property appraisal?

Response: An extraordinary assumption is defined as:

an assumption, directly related to a specific assignment, as of the effective date of the assignment results, which, if found to be false, could alter the appraiser's opinions or conclusions.

Comment: Extraordinary assumptions presume as fact otherwise uncertain information about physical, legal, or economic characteristics of the subject property; or about conditions external to the property, such as market conditions or trends; or about the integrity of data used in an analysis.

A hypothetical condition is defined as:

a condition, directly related to a specific assignment, which is contrary to what is known by the appraiser to exist on the effective date of the assignment results, but is used for the purpose of analysis.

Comment: Hypothetical conditions are contrary to known facts about physical, legal, or economic characteristics of the subject property; or about conditions external to the property, such as market conditions or trends; or about the integrity of data used in an analysis.

Appraisers may need to use extraordinary assumptions or hypothetical conditions in performing an assignment. When used in an assignment they become part of the givens in that assignment and have a significant effect on the appraiser's opinions and conclusions.

The difference between whether a condition is an extraordinary assumption or a hypothetical condition rests on what the appraiser knows about the condition in question.

If an appraiser cannot verify a certain condition that is critical to the valuation, but which the appraiser has a reasonable basis to accept as true, then the condition is an extraordinary assumption. The appraiser must comply with appropriate Standards having to do with both the development and reporting of the condition as an extraordinary assumption.

If, on the other hand, an appraiser is asked to use a condition he knows to be false, but which is necessary for the analysis, a hypothetical condition can be used. Appraisers must clearly distinguish false conditions from those other assumptions or conditions that are believed or taken to be true. To properly distinguish these two, the false conditions are called hypothetical conditions.

The best way to distinguish the two is to determine whether the condition in question is known to be false. If, as of the effective date of the appraisal, the condition is known to be false, then it is a hypothetical condition. If, as of the effective date of the appraisal, the fact of the condition is unknown and it is reasonable to believe that the condition is true, then the condition is an extraordinary assumption.

The following assumptions would be extraordinary if their use had a significant effect on the appraiser's opinions and conclusions:

1. Appraising proposed improvements, such as new construction or additions, as of the date of completion (a prospective date of value).
2. Appraising a property as if it were free of environmental contamination when it is not known to be contaminated.
3. Appraising a site as if sewer were available when the fact is unknown and there is no apparent evidence that the sewer is not available.
4. Appraising a site under an assumed zoning when the zoning is not known and there is no evidence that the assumed zoning is not possible.
5. Appraising irrigated farmland on the premise that the water supply is adequate for irrigated crop production, absent any evidence that the supply is not adequate.

205. HYPOTHETICAL CONDITIONS DESCRIBED

Question: What is a hypothetical condition? Can you give me some examples that might apply in a real property appraisal?

Response: A hypothetical condition is defined as:

a condition, directly related to a specific assignment, which is contrary to what is known by the appraiser to exist on the effective date of the assignment results, but is used for the purpose of analysis.

Comment: Hypothetical conditions are contrary to known facts about physical, legal, or economic characteristics of the subject property; or about conditions external to the property, such as market conditions or trends; or about the integrity of data used in an analysis.

Examples of hypothetical conditions that might be necessary in a real property appraisal assignment include:

1. Appraising proposed improvements such as new construction or additions, as if they existed as of a current date, when they do not.
2. Appraising a property as if it were free of any contamination when it is known to be contaminated.
3. Appraising a site as if sewer were available when the sewer is not available.
4. Appraising a site as if the zoning were different.
5. Appraising irrigated farmland on the premise that the water supply is adequate for irrigated crop production, knowing that the existing supply is not adequate.

206. WHEN A HYPOTHETICAL CONDITION MAY BE USED

Question: May an appraiser use any type of hypothetical condition in developing an appraisal?

Response: No. The Comment to Standards Rule 1-2(g) states:

*A hypothetical condition may be used in an assignment **only if**:*

- *use of the hypothetical condition is clearly required for legal purposes, for purposes of reasonable analysis, or for purposes of comparison;*
- *use of the hypothetical condition results in a credible analysis; and*
- *the appraiser complies with the disclosure requirements set forth in USPAP for hypothetical conditions. (Bold added for emphasis)*

Standards Rules 6-2(i), 7-2(g) and 9-2(g) contain similar Comments.

207. BEFORE ACQUISITION VALUE AND STANDARDS RULE 1-4(F)

Question: I'm doing an appraisal assignment for a government agency that is subject to the provisions of The Uniform Relocation Assistance and Real Property Acquisitions Act of 1970, as Amended (commonly known as, the Uniform Act), and its implementing regulation, 49 CFR Part 24. In the before acquisition value appraisal, the regulation requires appraisers to disregard any decrease or increase in the market value of the property that has been caused directly by the project. This regulation appears to conflict with USPAP, Standards Rule 1-4(f), which addresses the analysis of the effect on value of anticipated public or private improvements.

Obviously, I must comply with the Federal law and regulations, but I am unsure how to reconcile this with the requirements of USPAP, Standards Rule 1-4(f). Does this situation create a USPAP jurisdictional exception or is this simply an assignment condition?

Response: When it applies, 49 CFR Part 24 is an assignment condition.)The 49 CFR Part 24 regulation that requires appraisers to disregard any decrease or increase in the market value of the property that has been caused directly by the project in the before acquisition value appraisal is not a jurisdictional exception because the regulation does not conflict with the requirements of USPAP. A jurisdictional exception is only created where USPAP compliance is precluded by a requirement of law or regulation. Standards Rule 1-4(f) becomes applicable in an assignment only when the scope of work includes the analysis of anticipated improvements.

When analyzing anticipated public or private improvements, located on or off the site, an appraiser must analyze the effect on value, if any, of such anticipated improvements to the extent they are reflected in market actions. (Bold added for emphasis.)

The intended use of the assignment drives the appraiser's decisions in identifying relevant property characteristics and assignment conditions. The decision to analyze the effect on value of an anticipated off-site improvement is part of the scope of work decision. The scope of work in before acquisition value assignments prepared under the Uniform Act is based on a condition that anticipated project improvement will not be recognized; therefore Standards Rule 1-4(h) does not apply.

In an appraisal with an assumed condition that is contrary to known fact, the assumed condition is a hypothetical condition. A before acquisition value appraisal assignment that does not include recognition of the project would require the use of a hypothetical condition because this is contrary to a known fact. The Comment to Standards Rule 1-2(g) states:

*A hypothetical condition may be used in an assignment **only if**: use of the hypothetical condition is clearly required for legal purposes, for purposes of reasonable analysis, or for purposes of comparison; use of the hypothetical condition results in a credible analysis; and the appraiser complies with the disclosure requirements set forth in USPAP for hypothetical conditions. (Bold added for emphasis.)*

In the reporting of a real property appraisal report, USPAP Standards Rule 2-1(c) states that the real property appraisal report must:

*clearly and accurately disclose all assumptions, extraordinary assumptions, **hypothetical conditions**, and limiting conditions used in the assignment. (Bold added for emphasis.)*

This requirement creates an obligation to disclose all hypothetical conditions used in the assignment. USPAP real property appraisal report requirements state that the report must, at a minimum:

clearly and conspicuously:

- *state all extraordinary assumptions and **hypothetical conditions**; and*
- *state that their use might have affected the assignment results; (Bold added for emphasis.)*

This requirement directs the appraiser to provide a clear and conspicuous statement of the hypothetical conditions. The form and location of the statement is left to the discretion of the appraiser, but it must be clear and conspicuous to intended users.

208. REPORTING USE OF EXTRAORDINARY ASSUMPTIONS AND HYPOTHETICAL CONDITIONS

Question: What are the USPAP reporting requirements relating to the use of extraordinary assumptions and hypothetical conditions in an appraisal assignment?

Response: The report must clearly disclose the use of extraordinary assumptions and hypothetical conditions and notify intended users that the extraordinary assumptions and hypothetical conditions might have affected the assignment results.

For example, Standards Rule 2-1(c) states that each written or oral real property appraisal report must:

*clearly and accurately disclose all assumptions, extraordinary assumptions, hypothetical conditions, and limiting conditions **used** in the assignment. (Bold added for emphasis)*

This requirement creates an obligation to disclose all extraordinary assumptions and hypothetical conditions used in the assignment.

For example, Standards Rule 2-2(a)(x) states that a Self-Contained Appraisal Report must, at a minimum:

clearly and conspicuously:

- *state all extraordinary assumptions and hypothetical conditions; and*
- *state that their use might have affected the assignment results; (Bold added for emphasis.)*

This requirement directs the appraiser to provide a clear and conspicuous statement of the extraordinary assumptions and hypothetical conditions. The form and location of the statement is left to the discretion of the appraiser, but it must be clear and conspicuous to intended users.

The requirement further directs the appraiser to provide notice to intended users that the use of the extraordinary assumptions and hypothetical conditions might have affected the assignment results. The appraiser is not required to report on the impact of the extraordinary assumptions and hypothetical conditions on assignment results.

Note: The requirements for other report types are similar.

209. MUST A HYPOTHETICAL CONDITION OR EXTRAORDINARY ASSUMPTION BE LABELED?

Question: **If I employ a hypothetical condition or an extraordinary assumption in an assignment, does USPAP require me to label it as such?**

Response: No. USPAP does not require use of the specific terms *hypothetical condition* or *extraordinary assumption*. USPAP requires that all hypothetical conditions and extraordinary assumptions be disclosed clearly and conspicuously, and it must be disclosed that their use might affect the assignment results.

210. VALUE AS IF COMPLETED

Question: **My client, a federally regulated lender, has requested a market value appraisal as of the current date of a site that has all necessary approvals for development of a multi-family project with 30 units. My client intends to use the appraisal in underwriting the credit in a land acquisition loan. Must I develop an opinion of value for the completed project?**

Response: No. As long as the intended use is as you described, the appraisal assignment does not require a current value of the project with the hypothetical condition of it being completed. This is because the subject of your assignment is the site with the existing entitlement to develop the multi-family project, and presumes those entitlements are consistent with the highest and best use of the site.

Since your appraisal is as of a current date, and the property that is the subject of your appraisal is a property that actually exists under the zoning and entitlements in place as of that date, there is no need to use a hypothetical condition, nor to develop an opinion of value of the property after, or as though, it has been developed.

211. APPRAISING A PROPERTY NOT IN AS-IS CONDITION

Question: Our local community public works department has declared a parcel of land surplus and asked me to appraise the real property at market value with an effective date of the appraisal prior to its advertisement for sale. However, the public works director said there will be a covenant placed on the land immediately prior to the sale that will restrict its use to open space or recreation, and the value in my appraisal is to reflect that title condition. Currently, the property is in use by the public works department and does not have such a use limitation.

Since I know the as-is condition of the property title is not as the director described it, can I do the appraisal as if the covenant was in place?

If so, would this covenant be an extraordinary assumption or a hypothetical condition in the appraisal?

Response: (a) Given the type and definition of value (market value with the title conditioned as the director described), and intended use of the assignment results (to provide the client with information for use in deciding an asking price), the appraisal must reflect an analysis as if the covenant were in place.

(b) The appraisal of the property as though it had the covenant in place requires a hypothetical condition in the appraisal, because, as of the effective date of the appraisal, the property did not have the covenant in place (i.e., the covenant is *contrary to what is known by the appraiser to exist on the effective date of the assignment results* as stated in the USPAP definition of hypothetical condition).

If instead you did not know whether the covenant was or was not in place as of the effective date of the appraisal, but you based the appraisal on the covenant being in place, the appraisal would be based on an extraordinary assumption. This is because you would be presuming as fact otherwise uncertain information about the condition of title which, if found to be false, could alter your opinions or conclusions.

If, instead of saying there would be a covenant recorded after the effective date of the appraisal, the director provided a title document that said the covenant was already in place, the appraisal would not require either a hypothetical condition or an extraordinary assumption about that land use limitation. This is because the title condition used in the appraisal would have been the actual condition in place on the effective date of the appraisal.

212. ANALYZING THE LEASE WHEN APPRAISING FEE SIMPLE INTEREST

Question: I am performing an appraisal of a single-family dwelling that is in use as a rental property. The type of value to be developed is an opinion of market value for the fee simple interest. The current lease on the property is significantly below market and runs for another 24 months past the date of value in my appraisal. Furthermore the lease would survive a transfer of ownership.

Does USPAP require that I analyze and reflect the presence of the lease in the valuation?

Response: No; the subject of your assignment is the fee simple interest, not the leased fee interest. The appraisal report must provide adequate disclosures to any user of the appraisal that there is a lease in effect, and that the value of the leased fee interest in the property has not been reflected in the appraisal.

213. DEFINITION OF EXTRAORDINARY ASSUMPTION

Question: I recently accepted an appraisal assignment for a property that had an affirmative surface easement granted in perpetuity. The client was also the property owner. She did not have a copy of the easement and stated that it had never been recorded. What are my development and reporting obligations under USPAP?

Response: You should do what research is possible to see if the easement was recorded and consider the facts you discover in your analysis. If you cannot confirm the facts, you may use an extraordinary assumption in your analysis. The particulars of the use of the extraordinary assumption must be clearly and accurately disclosed.

The definition of an extraordinary assumption is:

an assumption, directly related to a specific assignment, as of the effective date of the assignment results, which, if found to be false, could alter the appraiser's opinions or conclusions.

*Comment: Extraordinary assumptions presume as fact otherwise uncertain information about physical, **legal**, or economic characteristics of the subject property; or about conditions external to the property, such as market conditions or trends; or about the integrity of data used in an analysis. (Bold added for emphasis)*

Standards Rule 2-1(c) states, in part:

Each written or oral real property appraisal report must:

- (c) clearly and accurately disclose all assumptions, extraordinary assumptions, hypothetical conditions, and limiting conditions used in the assignment.*

APPRAISAL DEVELOPMENT – SUBJECT PROPERTY SALES HISTORY

214. MULTIPLE SALES OR TRANSFERS OF THE SUBJECT PROPERTY

Question: If the subject property, such as a single-family dwelling, has sold more than once in the three (3) years prior to the effective date of the appraisal, am I required to analyze all of the sales, or just the most recent sale? Also, what am I required to do if a transfer of ownership is due to a foreclosure sale, or is a sale between family members or other related parties?

Response: Standards Rule 1-5 states:

When the value opinion to be developed is market value, an appraiser must, if such information is available to the appraiser in the normal course of business;

- (a) analyze all agreements of sale, options, or listings of the subject property current as of the effective date of the appraisal; and*
- (b) analyze all sales of the subject property that occurred within three (3) years prior to the effective date of the appraisal.*

The Comment to Standards Rules 2-2(a)(viii), (b)(viii), and (c)(viii) requires the written appraisal report to disclose the analysis of *the subject sales, options, and listings in accordance with Standards Rule 1-5*. It also states, *if such information is unobtainable, a statement on the efforts undertaken by the appraiser to obtain the information is required. If such information is irrelevant, a statement acknowledging the existence of the information and citing its lack of relevance is required.*

Therefore, you must report and analyze all of the sales, not just the most recent one. This would also include any type of sale, whether it was arm's length or not. If a transfer of ownership was the result of a sale between family members or otherwise related parties, or involved a foreclosure sale, the appraiser is still obligated to analyze and report it.

In addition, if sales beyond the minimum three year period, or options and listings that may not be current are identified and relevant to the appraisal of the subject property, they should also be analyzed and reported.

It is important to understand that assignment conditions for some appraisal assignments, particularly those in which the March 2005 version of Fannie Mae Form 1004/Freddie Mac Form 70 is used for the report, require that the appraiser also report and analyze transfers of ownership that did not necessarily result from a sale transaction.

Refer to Advisory Opinion 1, *Sales History*, for further guidance.

215. OFFERS TO PURCHASE SUBJECT PROPERTY

Question: Are offers to purchase the subject property, prior to the effective date of the appraisal, pertinent information required to be considered under Standards Rule 1-5?

Response: Standards Rule 1-5(a) states:

When the value opinion to be developed is market value, an appraiser must, if such information is available to the appraiser in the normal course of business:

analyze all agreements of sale, options, or listings of the subject property current as of the effective date of the appraisal;...

Standards Rule 1-5(a) does not require that an offer to purchase the subject property, that is prior to the effective date of the appraisal, be considered and analyzed. Agreements of sale and options are generally significant to solving an appraisal problem because they involve a meeting of the minds about the property's value between the potential buyer and seller. A listing of the subject property is likewise significant in that it indicates the property's availability in the market. A mere offer to purchase by a potential buyer, however, does not necessarily correlate to the property's value or even to the owner's desire to sell. Furthermore, information about a purchase offer is often confidential and sometimes may not be available to the appraiser in the normal course of business.

Nevertheless, the appraiser is required by Standards Rule 1-1(b) to *not commit a substantial error of omission or commission that significantly affects an appraisal*. If information about a purchase offer is available to the appraiser, even if the offer is not current, and that information is relevant to solving the appraisal problem, it must be considered. In some cases, an offer would be relevant to the appraisal problem only because it points to other information concerning the property or the market about which the appraiser should know. For example, if the appraiser learns of an offer that seems out of character with market trends, additional research might lead the appraiser to discover property or market characteristics that support that offering price.

216. CURRENT SALES CONTRACT IS NOT PROVIDED

Question: I am an appraiser with several bank clients that do not provide a copy of the current sales contract as a part of their standard appraisal ordering procedures. In addition, the parties to the transaction have been requested by the client not to provide either the contract or information contained in the sales contract to the appraiser. If the client withholds the current pending sale contract, can I still perform the assignment in compliance with USPAP?

Response: Yes. Standards Rules 1-5 and 7-5 require real and personal property appraisers to analyze all agreements of sale that are current at the effective date of the appraisal *if such information is available to the appraiser in the normal course of business*. Since these contracts are not available to you, you can complete the assignment and still be in compliance with USPAP.

However, the Comment to Standards Rules 1-5 and 7-5 reference the related reporting Standards Rules which require the appraiser to include a *statement on the efforts of the appraiser to obtain the information* in the report. Therefore, if you have attempted to obtain the current contract and could not, you must disclose how you attempted to obtain the contract in your report.

For more information regarding the meaning of normal course of business, see Advisory Opinion 24, *Normal Course of Business*, which is applicable to both real and personal property.

217. PENDING SALES AS COMPARABLES

Question: Can a pending sale be used as a comparable if the fact that the sale is pending is disclosed in the appraisal report?

Response: Yes. USPAP does not require the use of a pending sale as a comparable, nor does USPAP prohibit such use.

In addition, Standards Rule 1-1(b) requires that an appraiser:

not commit a substantial error of omission or commission that significantly affects an appraisal;

Not considering a pending sale of a property highly similar to the subject property could constitute an omission that would significantly affect the appraisal. USPAP requires appraisers to be complete in their analysis and convey that analysis in a way that is not misleading. Details of pending sales information, by their very nature, are often confidential. The appraiser must take care not to disclose information that he or she knows is confidential.

218. SUBJECT PROPERTY SALES HISTORY AND PROPERTY FLIPPING

Question: Since many flipping schemes rely on appraisals, what kinds of things should appraisers look for to avoid being inadvertently entangled in such schemes?

Response: There are a number of actions appraisers can take to safeguard against inflated appraisals. Standards Rule 1-5 requires that appraisers analyze all current agreements of sale, options, or listings of the subject property, when such information is available in the normal course of business. Many lenders require that agreements of sale be provided to the appraiser for their review and analysis. Sometimes the second or third leg of a flip can be discovered when the seller in the sale agreement is not the owner of record. Verification of the terms of sale with brokers may also reveal multiple transactions on the same property.

Experienced appraisers can recognize anomalies in the market and will avoid relying on sales that do not reflect the prevailing market. If asked to value a property in an unfamiliar area, an appraiser should become familiar with the area and the market for the subject property. The Comment to the COMPETENCY RULE states:

Competency may apply to factors such as, but not limited to, an appraiser's familiarity with a specific type of property or asset, a market, a geographic area, an intended use, specific laws and regulations, or an analytical method. If such a factor is necessary for an appraiser to develop credible assignment results, the appraiser is responsible for having the competency to address that factor or for following the steps outlined below to satisfy this COMPETENCY RULE.

and,

In an assignment where geographic competency is necessary, an appraiser who is not familiar with the relevant market characteristics must acquire an understanding necessary to produce credible assignment results for the specific property type and market involved.

Standards Rule 1-4 requires the appraiser, in developing a real property appraisal, to collect, verify and analyze all information necessary for credible assignment results. Knowing the conditions of

sale, financing and motivations of the buyer helps the appraiser to adjust sales to the market and avoid the affects of inflated prices.

Standards Rule 1-2(e) requires that the appraiser identify the characteristics of the property that are relevant to the type and definition of value and intended use of the appraisal including, its location and physical, legal, and economic attributes. Knowledge of these attributes plays a critical role in the identification of the problem to be solved and the determination of an appropriate scope of work. Appraisers should exercise care in identifying these attributes noting any adverse condition that could impact the property's value.

219. SUBJECT PROPERTY AS A COMPARABLE SALE

Question: Is it a violation of USPAP to use a recent sale of the subject property as a comparable in the sales comparison approach to value?

Response: No. Standards Rule 1-4, states:

In developing a real property appraisal, an appraiser must collect, verify, and analyze all information necessary for credible assignment results.

(a) *When a sales comparison approach is necessary for credible assignment results, an appraiser must analyze such comparable sales data as are available to indicate a value conclusion.*

Additionally, Standards Rule 1-5(b), states:

When the value opinion to be developed is market value, an appraiser must, if such information is available to the appraiser in the normal course of business:

(b) *analyze all sales of the subject property that occurred within the three (3) years prior to the effective date of the appraisal.*

Therefore, not only could the subject property potentially be used as a comparable sale, but an analysis of the prior sale must be made in accordance with Standards Rule 1-5 if it occurred within the prior three years. However, appraisers are cautioned to be aware of possible assignment conditions that require minimum numbers of comparable sales to be reported in addition to the sale of the subject property.

220. FIVE-YEAR SALES HISTORY AS AN ASSIGNMENT CONDITION

Question: My state appraisal board has adopted a regulation requiring appraisers to provide a five-year sales history for the subject property in all assignments. Is this situation addressed in USPAP?

Response: Yes. In the scenario described, an administrative agency (the state appraisal board) has a regulation that adds to the requirements in USPAP. Therefore, failure to comply with the regulation would be a violation of the SCOPE OF WORK RULE.

Assignment conditions include assumptions, extraordinary assumptions, hypothetical conditions, laws and regulations, jurisdictional exceptions, and other conditions that affect the scope of work. Laws include constitutions, legislative and court-made law,

administrative rules, and ordinances. Regulations include rules or orders, having legal force, issued by an administrative agency.

221. ANALYSIS OF SUBJECT PROPERTY SALES HISTORY

Question: Is it true that USPAP requires real property appraisers to analyze all sales of the subject property that occurred in the three years prior to the appraisal date, even for one-to-four family dwellings?

Response: Yes. Standards Rule 1-5, states:

When the value opinion to be developed is market value, an appraiser must, if such information is available to the appraiser in the normal course of business:

- (a) analyze all agreements of sale, options, or listings of the subject property current as of the effective date of the appraisal; and*
- (b) **analyze all sales of the subject property that occurred within the three (3) years prior to the effective date of the appraisal***

Comment: See the Comments to Standards Rules 2-2(a)(viii), 2-2(b)(viii), and 2-2(c)(viii) for corresponding reporting requirements relating to the availability and relevance of information. (Bold added for emphasis)

The three-year time period applies to **all** real property appraisals.

222. SALES HISTORY FOR NEW CONSTRUCTION

Question: I have received an assignment to appraise a property with newly constructed improvements. Because the property includes new construction, there is no prior sales history of the property as it now exists. However, I do have information pertaining to a prior sale of the site (without the improvements). Does Standards Rule 1-5(b) require me to analyze this prior sale of the site?

Response: Yes. The goal of USPAP is to promote public trust in the appraisal profession. Standards Rule 1-5 provides for a research and analysis requirement for information that is judged to be important to the credibility of the appraisal process. To be consistent with the purpose of USPAP as well as the intent of SR 1-5, an appraiser is required to analyze *all* prior sales that include the subject property. This includes: 1) prior sales of a property that includes the subject property; and 2) prior sales of a portion of the subject property.

In this case, the analysis of the prior sale of the unimproved site would be necessary to comply with Standards Rule 1-5(b). The site in this instance is a component of the subject property.

Another example might be the appraisal of a leased fee interest in a property. The appraiser must research and analyze prior sales of the subject, even if these sales include a fee simple interest in the property.

An additional example might be the appraisal of 20 acres subdivided from a 200-acre parcel. The appraiser must research and analyze prior sales of the subject, even if these sales include the 200-acre site in its entirety.

223. APPRAISAL WITHOUT KNOWING SALE PRICE

Question: I have been asked to perform an appraisal of a residential dwelling that I know is under contract. No lender is involved and the buyer and seller do not want the appraiser to know the amount of the sales contract. Can I accept this assignment and still comply with USPAP?

Response: Yes. USPAP does not contain a requirement for the appraiser to know the pending sale price of a subject property. Standards Rule 1-5(a) does require the appraiser to analyze all current agreements of sale and options to purchase or listings of the subject property, when available during the normal course of business.

*When the value opinion to be developed is market value, an appraiser must, if such information is available to the appraiser **in the normal course of business**, analyze all agreements of sale, options, and listings of the subject property current as of the effective date of the appraisal. (Bold added for emphasis)*

However, if the appraiser's scope of work and the normal course of business render the subject property's pending transaction details unavailable, the appraiser may be able to comply with USPAP without obtaining the information. For more information on the normal course of business, please see Advisory Opinion 24, *Normal Course of Business*.

It should be noted that when the amount of the sale contract is unknown, this does not eliminate the appraiser's responsibility to analyze other information that is available related to the pending sale. This can include information such as marketing history and other details of the pending sale that may be available.

224. ANALYSIS OF SALES HISTORY FOR COMPARABLE SALES

Question: I was told that USPAP now requires real property and personal property appraisers to analyze previous sales of comparable properties used in the sales comparison approach to value. Is this true?

Response: No. However, there may be applicable laws, regulations or other assignment conditions in certain appraisal assignments that require the appraiser to provide a more detailed analysis than otherwise required by USPAP.

225. SALES HISTORY ANALYSIS FOR DEED IN LIEU OF FORECLOSURE

Question: I am currently appraising an office building that was transferred 18 months ago via a deed in lieu of foreclosure. Am I required to analyze this transaction?

Response: Yes. Advisory Opinion 4 (AO-4), *Standards Rule 1-5(b)*, states, in part:

The intent of Standards Rule 1-5(b) is to encourage the research and analysis of prior sales of the subject property. All sales of the appraised property within the 3 year time period stated in Standards Rule 1-5(b) includes transfers in lieu of foreclosure and foreclosure sales.

AO-4 goes on to state:

Foreclosure sales and voluntary transfers of title by mortgagor to mortgagee in lieu of foreclosure are transactions grounded in objective necessity. Nevertheless, they are sales because they transfer ownership of and title to property for a valuable consideration.

226. OBLIGATION TO ANALYZE PRIOR LISTINGS OF SUBJECT PROPERTY

Question: I know that Standards Rule 1-5(a) requires an appraiser to analyze all current listings of the subject property. Does it also require analysis of *prior* listings of the subject property?

Response: No. However, in the development of an appraisal, an appraiser is required under Standards Rule 1-1(b), to *not commit a substantial error of omission or commission that significantly affects an appraisal*. If information about a prior listing is known by the appraiser, and that information is relevant to solving the appraisal problem, it must be considered.

Appraisers are cautioned to be aware that an analysis of the subject's prior listing history may be required by assignment conditions that apply to some assignments.

227. PROPER ANALYSIS OF AGREEMENT OF SALE

Question: I understand that Standards Rule 1-5(a) requires the appraiser to analyze an agreement of sale (if available in the normal course of business). What constitutes proper analysis?

Response: The term analyze is not defined in USPAP because it does not have a special meaning within the document or in Standards Rule 1-5. The term is used based on its English language meaning as found in common dictionaries.

The extent of the analysis performed to comply with the requirements of Standards Rule 1-5(a) is part of the scope of work decision. The acceptability of the appraiser's analysis is judged in the same way that any other scope of work decision is judged. For more information, please see the SCOPE OF WORK RULE, Advisory Opinion 28, *Scope of Work Decision, Performance, and Disclosure*, and Advisory Opinion 29, *An Acceptable Scope of Work*.

228. OBLIGATION TO ANALYZE WITHDRAWN OR EXPIRED LISTINGS

Question: I was asked to appraise a single-family residence for refinancing. I am aware that the property had been previously listed but did not sell. During my data investigation and analysis, I noted that the owner's estimate of value was \$375,000. When I looked up the listing history, I found it had been withdrawn from the market at the asking price of \$325,000. What are my obligations under USPAP regarding a withdrawn or expired listing of the subject property?

Response: Standards Rule 1-5(a) states:

When the value opinion to be developed is market value, an appraiser must, if such information is available to the appraiser in the normal course of business:

- (a) *analyze all agreements of sale, options, or listings of the subject property current as of the effective date of the appraisal.*

Therefore, there is not a specific requirement in Standards Rule 1-5(a) to consider and analyze a withdrawn or expired listing of the subject property, prior to the date of the appraisal.

However, any listing of the subject property prior to the effective date of the appraisal might be significant in that it indicates the property's previous availability in the market and the market's reaction to that availability. Likewise, agreements of sale and options are generally significant to the appraisal problem in that they involve a meeting of the minds relating to the property's value between a potential buyer and the seller.

In the development of an appraisal, an appraiser is required under Standards Rule 1-1(b), to *not commit a substantial error of omission or commission that significantly affects an appraisal*. If information about a withdrawn or expired listing is known by the appraiser, and that information is relevant to the appraisal problem, it must be considered.

229. SALES HISTORY ANALYSIS IN A RETROSPECTIVE APPRAISAL

Question: I have been asked to perform a retrospective appraisal on the fee simple interest in a real property. The effective date of the appraisal is September 1, 1995. Must I analyze listings of the subject that were current at that time and/or the sales history of the subject?

Response: Yes. Standards Rules 1-5(a) and (b) state:

When the value opinion to be developed is market value, an appraiser must, if such information is available to the appraiser in the normal course of business:

- (a) *analyze all agreements of sale, options, or listings of the subject property current as of the effective date of the appraisal; and*
(b) *analyze all sales of the subject property that occurred within the three (3) years prior to the effective date of the appraisal.*

If this information is available in the normal course of business, it must be analyzed and reported in conformance with Standards Rule 2-2(a)(viii), 2-2(b)(viii), or 2-2(c)(viii), whichever is applicable.

230. SALES HISTORY ANALYSIS FOR CONDITION AND MARKETABILITY REPORTS

Question: I have been asked to provide a client with a condition and marketability report on a residential property. I am to complete a form used by some lenders and secondary market participants. Since this assignment is part of appraisal practice (because I am providing this service as an appraiser), must I conform with the requirements in Standards Rule 1-5(a), to *analyze all agreements of sale, options, or listings of the subject current as of the effective date of the appraisal; and (b) analyze all sales of the subject property that occurred within the three (3) years prior to the effective date of the appraisal?*

Response: No. Standards Rule 1-5 only applies to the development of a real property appraisal. The assignment described in this question is not an appraisal since developing an opinion of value is

not part of the assignment. While the requirements of STANDARD 1 are not applicable, USPAP obligations that generally apply to appraisal practice are, including ethical behavior and competent performance.

APPRAISAL REPORTING – CERTIFICATION AND SIGNATURES

231. REASON FOR SIGNED CERTIFICATION

Question: Why does USPAP require an appraiser to include a signed certification in the workfile for oral reports and in all written reports?

Response: A signed certification evidences an appraiser’s recognition of his or her ethical obligations. Except for the discipline-specific terms for professional assistance and the fact that STANDARD 10 does not require comment on a personal inspection, the appraiser’s certification is the same for all written reports covered by the Standard Rules.

The elements of the certification that apply to development are listed as follows (taken from Standards Rule 2-3 for real property appraisals, as an example):

- *the statements of fact contained in this report are true and correct.*
- *the reported analyses, opinions, and conclusions are limited only by the reported assumptions and limiting conditions and are my personal, impartial, and unbiased professional analyses, opinions, and conclusions.*
- *I have no (or the specified) present or prospective interest in the property that is the subject of this report and no (or the specified) personal interest with respect to the parties involved.*
- *I have performed no (or the specified) services, as an appraiser or in any other capacity, regarding the property that is the subject of this report within the three-year period immediately preceding acceptance of this assignment.*
- *I have no bias with respect to the property that is the subject of this report or to the parties involved with this assignment.*
- *my engagement in this assignment was not contingent upon developing or reporting predetermined results.*
- *my compensation for completing this assignment is not contingent upon the development or reporting of a predetermined value or direction in value that favors the cause of the client, the amount of the value opinion, the attainment of a stipulated result, or the occurrence of a subsequent event directly related to the intended use of this appraisal.*

The element of the certification that applies to development and reporting is:

- *my analyses, opinions, and conclusions were developed, and this report has been prepared, in conformity with the Uniform Standards of Professional Appraisal Practice.*

The last two items have to do with disclosures relative to inspections and significant assistance:

- *I have (or have not) made a personal inspection of the property that is the subject of this report. (If more than one person signs this certification, the certification must clearly specify which individuals did and which individuals did not make a personal inspection of the appraised property.)*
- *no one provided significant real property appraisal assistance to the person signing this certification. (If there are exceptions, the name of each individual providing significant real property appraisal assistance must be stated.)*

232. **CHANGING THE CERTIFICATION**

Question: Must the certification be exactly the same as that presented in USPAP? May an appraiser add items to the certification?

Response: USPAP states that the report must contain a signed certification that is **similar** in content to the form provided in the Rules related to reporting. An appraiser may modify or add to the certification as necessary. For example, the names of appraisers providing significant appraisal assistance who do not sign the certification must be stated in the certification. There are also certification requirements in some jurisdictions for real property appraisal certifications and licenses as well as requirements related to membership in a professional association. Clients, intended users, and the intended use may also require additional certification items.

Appraisers using preprinted appraisal forms should be aware that clients and client groups may prohibit altering the preprinted certification used in assignments performed for them, but any such prohibition is not contained in USPAP.

233. **REQUIREMENT FOR SIGNING REPORTS**

Question: What is the USPAP requirement regarding signing a report?

Response: USPAP requires that each written report include a signed certification. Although many written reports include the appraiser's signature on the report or a letter of transmittal, this is not required by USPAP. However, an appraiser who signs any part of the report must also sign the certification. For an oral report, USPAP requires that a signed and dated certification be part of the workfile.

234. **SIGNATURE ON LETTER OF TRANSMITTAL**

Question: Does USPAP require an appraiser to sign the letter of transmittal?

Response: No. USPAP does not require that any report include a letter of transmittal. However, USPAP does require that an appraiser who signs a letter of transmittal must also sign the certification required in Standards Rules 2-3, 3-6, 5-3, 6-9, 8-3, and 10-3.

For example, the Comment to Standards Rule 2-3 states, in part:

A signed certification is an integral part of the appraisal report. An appraiser who signs any part of the appraisal report, including a letter of transmittal, must also sign this certification. (Bold added for emphasis.)

235. MULTIPLE SIGNATURES ON APPRAISAL REPORTS

Question: I am a review appraiser for a national mortgage company. I recently received a residential appraisal reported on a commonly used form that has two signatures on the appraiser line (left hand side of the form). Both appraisers also signed the certification. Does this violate *Uniform Standards of Professional Appraisal Practice (USPAP)*?

Response: This does not violate USPAP. The Comment to Standards Rule 2-3 states, in part:

An appraiser who signs any part of the appraisal report, including a letter of transmittal, must also sign this certification.

Therefore, if both real property appraisers signed the appraisal report, then both must sign the certification. The Comment goes on to say:

any appraiser(s) who signs a certification accepts full responsibility for all elements of the certification, for the assignment results, and for the contents of the appraisal report.

In this scenario, both real property appraisers will have complete responsibility for the appraisal in its entirety.

236. SIGNATURE AUTHORIZATION

Question: Can I authorize someone else to sign an appraisal report for me, using my signature? If so, could you identify what steps I must take to do this correctly?

Response: USPAP does not specifically state that the appraiser can only personally sign a report. It does state, in the definition of signature, that the signature be *personalized evidence indicating authentication*. The ETHICS RULE of USPAP also states, in part,

An appraiser may authorize the use of his or her signature only on an assignment-by-assignment basis.

An appraiser must not affix the signature of another appraiser without his or her consent.

Standard Rule 2-3 states: *Each written real property appraisal report must contain a signed certification...*

In the DEFINITIONS section, a signature is defined as:

personalized evidence indicating authentication of the work performed by the appraiser and the acceptance of the responsibility for content, analyses, and the conclusions in the report.

Unless specifically contrary to the law of a particular jurisdiction, USPAP allows another person to sign for an appraiser, as long as it is with the appraiser's specific authorization and is clear and does not result in a misleading report. One solution would be for that other person to sign the appraiser's name and then write their own initials along side the signature, preceded by the word by (for example, "by sbk").

237. **AUTHORIZING THE USE OF YOUR DIGITAL SIGNATURE**

Question: I am in a situation where I need to authorize someone to apply my digital signature for me. This would require me to reveal my current Personal Identification Number (PIN) or password to that person. Can I do this in compliance with USPAP?

Response: Yes. Such action is not a violation of USPAP. The Management section of the ETHICS RULE states:

An appraiser may authorize the use of his or her signature only on an assignment-by-assignment basis.

An appraiser must not affix the signature of another appraiser without his or her consent.

238. **PROVIDING SIGNATURE TO CREATE A SIGNATURE FILE**

Question: I am a residential appraiser and I use software to generate my appraisal reports. The software company requires me to provide a copy of my signature to create an electronic signature file for use with the software. Does this action violate USPAP?

Response: No. This situation is analogous to providing a copy of your signature to a rubber stamp company for purposes of creating a signature stamp. Common business agreements in these situations limit use of the signature to creating the signature image. In providing a signature to a software company or rubber stamp company, the appraiser is not authorizing use of the signature.

239. **LOSING CONTROL OF A DIGITAL SIGNATURE**

Question: If my digital signature is stolen and applied to reports without my knowledge or consent, am I in violation of USPAP?

Response: No. Unauthorized use of the appraiser's signature is not a violation of USPAP. If the appraiser's digital signature is stolen, the appraiser is the victim of a crime. Any use of the signature is not authorized and beyond the appraiser's control. However, an appraiser must use due care to prevent unauthorized use of his/her signature. The Conduct section of the ETHICS RULE states, in part:

An appraiser may authorize the use of his or her signature only on an assignment-by-assignment basis.

An appraiser must not affix the signature of another appraiser without his or her consent.

Comment: *An appraiser must exercise due care to prevent unauthorized use of his or her signature. An appraiser exercising such care is not responsible for unauthorized use of his or her signature.* (Bold added for emphasis.)

This is analogous to a party who uses an appraiser's rubber signature stamp without permission from the appraiser, or a party who simply puts pen and ink to paper and forges an appraiser's signature. In these cases the appraiser did not give permission to use his or her signature.

240. RESPONSIBILITY OF AN APPRAISER SIGNING AS A SUPERVISOR

Question: I have been told that a supervisor or employer who signs a report is not as responsible as the individual preparing the appraisal and that using a conditional label next to the signature of the supervisor or employer exempts that individual from adherence to USPAP. Is this true?

Response: No. It is not true if the supervisor or employer is an appraiser. The Comment to Standards Rule 2-3 (as well as similar language in Standards Rules 3-6, 5-3, 6-9, 8-3 and 10-3) specifically states:

An appraiser who signs any part of the appraisal report, including a letter of transmittal, must also sign this certification.

In an assignment that includes only assignment results developed by the real property appraiser(s), any appraiser(s) who signs a certification accepts full responsibility for all elements of the certification, for the assignment results, and for the contents of the appraisal report.

241. SIGNING DIGITAL (ELECTRONIC) REPORTS

Question: What is the USPAP requirement for signing a digitally created (electronic) report?

Response: The requirement for paper (hard copy) and digital (electronic) reports is the same. The appraiser must include a signed certification with each report.

242. BUSINESS ENTITY SIGNING AN APPRAISAL REPORT

Question: Can a business entity, such as a corporation, sign an appraisal report?

Response: Yes. There is no prohibition against an entity signing a transmittal letter or the page stating the value conclusion of a report. However, USPAP does require that an individual appraiser(s) sign a certification, see Standards Rules 2-3, 3-6, 5-3, 6-9, 8-3, and 10-3:

Each written real property appraisal (personal property appraisal, mass appraisal, or business or intangible asset appraisal, appraisal review, real property appraisal consulting) report must contain a signed certification that is similar in content to the following form...(See Standards Rules 2-3, 3-6, 5-3, 6-9, 8-3, and 10-3 for the complete text.)

The Comment(s) to these Standards Rules refer to an appraiser(s), a signing appraiser(s), and any appraiser(s). Clearly, this language refers to an individual or individuals, not a corporate or business entity.

243. SIGNIFICANT APPRAISAL ASSISTANCE

Question: In preparing an appraisal assignment, I talk with many different people. I know the report certification must identify individuals who provide significant real property appraisal assistance. What is significant appraisal assistance?

Response: USPAP does not include a definition of significant appraisal assistance. However, aspects of this phrase can be explored to clarify its meaning.

First, the adjective significant means that the contribution must be of substance to the development of the assignment results. In other words, the individual must contribute to the valuation analysis in a noteworthy way. An individual who merely collects or provides data for use in the analysis does not provide significant appraisal assistance.

Secondly, the reference to the term appraisal assistance means that the contribution is related to the appraisal process or requires appraiser competency. One misconception is that non-appraisers who provide assistance should be identified in the certification. This is incorrect because the certification requirements in USPAP apply only to appraisers. Thus, only appraisers sign the certification or are identified as providing significant appraisal assistance. For example, the use of an environmental expert to determine wetland boundaries would not be considered significant real property appraisal assistance.

Examples of contributions made by appraisers that constitute significant real property appraisal assistance include the identification of comparable properties and data, inspection of the subject property and comparables, estimating accrued depreciation, or forecasting income and expenses.

244. SIGNIFICANT PROFESSIONAL ASSISTANCE (NEW)

Question 1: I am a research assistant with an appraisal firm that has three state certified or licensed real property appraisers. My responsibilities include preparing an appraisal file on each new assignment, researching past sales of the subject, obtaining zoning information, tax data, market information and sales research (including confirming the sales) for the three associates. The licensed or certified appraisers usually inspect the property and prepare the appraisal themselves. Currently, they do not recognize me in these reports, and I am not permitted to sign them.

I also sometimes go with them on inspections and write portions of the reports. In these cases they do recognize me, as required by USPAP. I am concerned about receiving experience credit for all my appraisal assistance from my state's appraiser licensing board or a professional association if I apply for a designation. Should my participation be referenced in all the reports when I provide assistance, or only when I inspect the property and write portions of the report?

Response 1: USPAP does not address the specific experience requirements of state appraiser licensing agencies or professional appraisal organizations. You will have to contact those entities directly to obtain that information.

USPAP *does* specifically address what to do when an individual provides significant assistance in the development of appraisal, appraisal review and real property appraisal consulting assignments. Each of the Standards that address reporting requires that such significant assistance be addressed in any report. For example, in real property appraising, Standards Rule 2-2 (a) (vii) states:

(vii) describe the scope of work used to develop the appraisal;

Comment: Because the intended users' reliance on an appraisal may be affected by the scope of work, the report must enable them to be properly informed and not misled. Sufficient information includes disclosure of research and analyses performed and might also include disclosure of research and analyses not performed.

When any portion of the work involves significant real property appraisal assistance, the appraiser must describe the extent of that assistance. The signing appraiser must also state the name(s) of those providing the significant real property appraisal assistance in the certification, in accordance with Standards Rule 2-3. (Bold added for emphasis)

USPAP does not define what significant assistance is in any particular appraisal, appraisal review or real property appraisal consulting assignment. You can, however, obtain more guidance on how to make a decision on whether your contributions to an assignment should be considered significant within USPAP by reviewing Advisory Opinion 31, *Assignments Involving More than One Appraiser*.

Clerical responsibilities such as file preparation, typing reports, and similar activities are not considered significant assistance. However, the participation you described goes well beyond clerical duties. The participation you describe *is* significant appraisal assistance and *must* be disclosed in the report. This should be accomplished by your identification in the certification as an individual who has provided significant appraisal assistance. The extent of your assistance must also be included in the report.

Question 2: How must recognition of my significant appraisal assistance be included when there is no written report, but significant assistance was provided and documentation of my work is in the workfile?

Response 2: The RECORD KEEPING RULE states that the workfile must include:

summaries of all oral reports or testimony, or a transcript of testimony, including the appraiser's signed and dated certification

Standards Rule 2-4 states:

To the extent that it is both possible and appropriate, an oral real property appraisal report must address the substantive matters set forth in Standards Rule 2-2(b).

Therefore, based on the requirements in USPAP, the workfile of an oral report must include a **signed certification stating the name of the person or persons providing significant appraisal assistance**. The oral report must also include a summary of the extent of that assistance because Standards Rule 2-4 requires that oral reports address the substantive matters set forth in Standards Rule 2-2(b), which are the requirements for a Summary Appraisal Report. (Bold added for emphasis)

NOTE: This Q&A focuses on significant real property appraisal assistance. The same type of disclosure is also required in STANDARDS 3, 5, 6, 8, and 10 as they relate to the appraisal of other types of property, appraisal review, real property appraisal consulting and mass appraisal.

245. DOES USPAP DEFINE SUPERVISORY APPRAISER?

Question: The term supervisory appraiser is used in many appraisal reports, particularly residential appraisal reports. Does USPAP define supervisory appraiser?

Response: No. USPAP does not define or otherwise address this term. The term supervisory appraiser was introduced by the authors of several widely used residential appraisal report forms.

However, it should be noted that an appraiser who signs any part of the appraisal report, including a letter of transmittal, must also sign the certification.

246. REPORTING SIGNIFICANT REAL PROPERTY APPRAISAL ASSISTANCE

Question: I am currently working in an appraisal firm as a trainee. As part of my training I contribute significant real property appraisal assistance in appraisal assignments performed by other appraisers in the firm, but I do not sign the appraisal report or the certification. I understand that my name must be stated in the certification. Must the certification include a description of my assistance?

Response: No. A description of your assistance or contribution to the assignment is not required in the certification. However, in accordance with Standards Rule 2-2(a)(vii), (b)(vii), and (c)(vii) the extent of the assistance must be described, summarized or stated (depending on the reporting option used) within the report. This required disclosure could be included within the certification, but it could also be included in some other section of the report.

See AO-31, *Assignments Involving More than One Appraiser*, for further guidance.

247. RELYING ON THE REPORTS OF OTHERS (NEW)

Question: I am a business appraiser and do not perform real property appraisal assignments. As a result, I sometimes rely on the results of a real property appraisal to determine the value of business equity. The real property appraisal report is not contained in my business valuation report; however, the real property value conclusion (the dollar amount) is indicated in my report. An example of this would be a real property holding company in which the value of the equity may be significantly dependent on the value of the owned real property. What is the appropriate way to address such reliance on the real property appraisal within my business valuation appraisal report?

Response: The Comment to SR 10-3 states, in part:

When a signing appraiser(s) has relied on work done by appraisers and others who do not sign the certification, the signing appraiser is responsible for the decision to rely on their work. The signing appraiser(s) is required to have a reasonable basis for believing that those individuals performing the work are competent. The signing appraiser(s) also must have no reason to doubt that the work of those individuals is credible.

Additionally, the Conduct section of the ETHICS RULE states, in part:

An appraiser must not use or communicate a misleading or fraudulent report...

The business valuation report should specifically reference the source of the real property value and may incorporate that value conclusion by use of an extraordinary assumption. Disclosure of the extraordinary assumption could be similar to the following:

“The fair market value of the subject interest in XYZ Company is dependent on the market value of the real property owned by the Company, as provided to us. We have not verified the validity of this asset value, which we assume to be reliable. The use of this assumption might have affected our assignment results.”

The business appraisal report must contain a certification by the business appraiser(s). A signed certification related to the real property appraisal will be in the report provided by the real property appraiser (or in the workfile in the case of an oral report).

The business appraiser must rely on a real property appraiser because the business appraiser in this scenario is not competent to perform a real property appraisal or to review the real property appraisal.

In deciding that the individual providing the real property appraisal is competent, the business appraiser might note such things as the real property appraiser's:

- declaration in a signed certification that the analyses, opinions and conclusions were developed, and the report was prepared, in conformance with USPAP;
- relevant experience, education, or references; or
- evidence of professional status, such as license, professional designation, or other recognition of professional or academic achievement.

It is important to note that the determination of another appraiser's competency may not be established by a single factor, but instead may require a combination of factors. Ultimately, it would be the business valuation appraiser's decision as to whether the real property appraiser is competent, and that decision must be based on reasonable criteria. In addition, it is of paramount importance that the business valuation appraiser has no reason to doubt that the work of the real property appraiser is credible.

248. DISAGREE WITH SUPERVISOR ON VALUE CONCLUSION

Question: I am employed at a firm where my reports are reviewed by a supervisory appraiser. The supervisory appraiser recently asked me to make changes to a report that resulted in a value opinion with which I do not agree. I am not comfortable signing the amended report. What are my obligations under USPAP?

Response: If the report does not represent your own opinions and conclusions, then you must not sign the report or the certification.

The Comment to Standards Rule 2-3 states: *An appraiser who signs any part of an appraisal report, including a letter of transmittal, must also sign a certification...* which must include a statement similar to:

*I certify that, to the best of my knowledge and belief...the reported analyses, opinions, and conclusions are limited only by the reported assumptions and limiting conditions and are **my personal, impartial, and unbiased professional analyses, opinions, and conclusions.** (Bold added for emphasis)*

An appraiser required to make changes that he or she does not agree with would not be reporting his or her own personal analyses, opinions, or conclusions.

249. DOES THE CERTIFICATION ON THE UNIFORM RESIDENTIAL APPRAISAL REPORT (URAR) FORM ALSO EXTEND TO THE MARKET CONDITIONS ADDENDUM?

Question: When I complete the new Market Conditions form (such as the Fannie Mae 1004MC/Freddie Mac 71) and include it within my report, does the certification contained in the URAR form apply to the Market Conditions form as well?

Response: Yes. The name of the form in question is the *Market Conditions Addendum to the Appraisal Report*. Any addendum is part of a larger report (in this case, a URAR form). In addition, the Market Conditions form is clearly identified as an addendum, as evidenced by the following language at the top of the form:

The purpose of this addendum is to provide the lender/client with a clear and accurate understanding of the market trends and conditions prevalent in the subject neighborhood. This is a required addendum for all appraisal reports with an effective date on or after April 1, 2009.

The Comment to Standards Rule 2-3 states,

In an assignment that includes only assignment results developed by the real property appraiser(s), any appraiser(s) who signs a certification accepts full responsibility for all elements of the certification, for the assignment results, and for the contents of the appraisal report.

Thus, the certification applies to the entire appraisal and report, including any addenda.

250. MULTI-DISCIPLINE CERTIFICATION – REAL PROPERTY APPRAISER

Question: I am a real property appraiser who sometimes participates in assignments that include the appraisal of real property, personal property (machinery and equipment), and intangible assets. The value conclusions for each asset type are separately prepared by an appraiser with competency in the asset type. A single report is jointly issued that communicates the assignment results for all of the assets. What is the appropriate wording for the certification in these situations?

Response: Standards Rule 2-3 states, in part:

*Each written real property appraisal report must contain a signed certification that is **similar** in content to the following form:*

I certify that, to the best of my knowledge and belief:

- *the reported analyses, opinions, and conclusions ... are my personal, impartial, and unbiased professional analyses, opinions, and conclusions...*
- *my analyses, opinions, and conclusions were developed, and this report has been prepared, in conformity with the Uniform Standards of Professional Appraisal Practice...*

The Comment states, in part:

*In an assignment that includes only assignment results developed by the real property appraiser(s), any appraiser(s) who signs a certification accepts full responsibility for all elements of the certification, for the assignment results, and for the contents of the appraisal report. **In an assignment that includes personal property, business or intangible asset assignment results not developed by the real property appraiser(s), any real property appraiser(s) who signs a certification accepts full responsibility for the real property elements of the certification, for the real property assignment results, and for the real property contents of the appraisal report.** (Bold added for emphasis)*

When reporting assignment results that are separately prepared by appraisers from different disciplines, the certification must clearly define responsibility for all assignment results and report content. The certification language may be altered to indicate which reported conclusions each appraiser is certifying to. The certification language is not required to be exactly as presented in USPAP.

One solution would be for each appraiser to sign a separate certification that identifies the assignment results and report content for which they take responsibility. Another solution to this circumstance would be to include a single certification altered to indicate the assignment results and report content certified to by each appraiser.

Whatever solution is adopted, the certification language must identify the assignment results and report content for which the real property appraiser takes responsibility. One example of such language would be:

- the reported **real property** analyses, opinions, and conclusions ... are my personal, impartial, and unbiased professional analyses, opinions, and conclusions...
- my **real property** analyses, opinions, and conclusions were developed, and the **real property content** of this report has been prepared, in conformity with the *Uniform Standards of Professional Appraisal Practice*. (Bold added for emphasis.)

Each personal property appraiser must take responsibility for the personal property assignment results and report content. Each business and/or intangible asset appraiser must take responsibility for the business and/or intangible asset assignment results and report content.

251. RELYING ON THE REPORTS OF OTHERS

Question: I am a business appraiser; I am not a real property appraiser. Sometimes I rely on results of a real property appraisal to determine the value of business equity. The report of the real property value analysis is not contained in my business valuation report, although the dollar amount of the real property value conclusion is indicated in my report. An example of this would be a real property holding company in which the value of the equity may be significantly dependent on the value of the owned real property. What is the appropriate way to handle such reliance in my business appraisal report?

Response: The Comment to SR 10-3 states:

When a signing appraiser(s) has relied on work done by appraisers and others who do not sign the certification, the signing appraiser is responsible for the decision to rely on their work. The signing appraiser(s) is required to have a reasonable basis for believing that those individuals performing the work are competent. The signing appraiser(s) also must have no reason to doubt that the work of those individuals is credible.

The Conduct section of the ETHICS RULE states:

An appraiser:

- *must not communicate assignment results with the intent to mislead or to defraud;*
- *must not use or communicate a report that is known **by the appraiser** to be misleading or fraudulent;* (Bold added for emphasis.)

The business valuation report should specifically reference the source of the real property value and may incorporate that value conclusion by use of an extraordinary assumption. Disclosure of the extraordinary assumption could be similar to the following:

“The fair market value of the subject interest in XYZ Company is dependent on the market value of the real property owned by the Company, as provided to us. We have in no way attempted to justify or verify the validity of this asset value. If the real property value were different, the fair market value of the subject interest in XYZ Company could be different.”

The business appraisal report would contain a certification by the business appraiser(s). A signed certification related to the real property appraisal will be in the report provided by the real property appraiser (or in the workfile in the case of an oral report).

The business appraiser must rely on a real property appraiser because the business appraiser in this scenario is not competent to perform a real property appraisal or to review the real property appraisal.

In deciding that the work of the real property appraiser is competent, the business appraiser might note such things as the other appraiser’s:

- declaration in a signed certification that the analysis, opinions and conclusions were developed, and the report was prepared, in conformance with USPAP;
- relevant experience, education, or references; or
- evidence of professional status, such as license, professional designation, or other recognition of professional or academic achievement.

252. MULTI-DISCIPLINE CERTIFICATION – PERSONAL PROPERTY APPRAISER

Question: I am a personal property appraiser. My value opinions are sometimes influenced by analysis performed by a business appraiser, such as assistance in determining whether earnings are sufficient to justify the otherwise-determined value in continued use of machinery and equipment. What are the certification requirements in this scenario?

Response: The personal property report may contain a single certification or two certification statements (one for the personal property appraiser and one for the business appraiser). In either case the certification language should be altered to indicate which reported conclusions each appraiser is certifying to. (See FAQ #250 *Multi-Discipline Certification – Real Property Appraiser*, for additional information.)

APPRAISAL REPORTING – USE AND FORMAT ISSUES

253. REQUIRED LEVEL OF DETAIL IN A SELF-CONTAINED APPRAISAL REPORT

Question: A colleague recently told me that she never prepares Self-Contained Appraisal Reports. She believes that it is impossible to write a report that contains all the information and analysis that supports her assignment results. I have heard others express similar thoughts. Is it true that a Self-Contained Appraisal Report must include an exhaustive account of my appraisal process?

Response: No. USPAP requirements for Self-Contained Appraisal Reports provide flexibility within a framework.

The key term in understanding the level of information in a Self-Contained Appraisal Report is *describe*. As stated in Advisory Opinion 11, *Content of the Appraisal Report Options of Standards Rules 2-2 and 8-2*:

*The Self-Contained Appraisal Report should contain all information **significant** to the solution of the appraisal problem. (Bold added for emphasis)*

*The intended users of the Self-Contained Appraisal Report should expect to find all **significant** data reported in comprehensive detail. (Bold added for emphasis)*

Describe is used to connote a comprehensive level of detail in the presentation of information.

The requirement is to provide all significant information and data, not all information and data. Significance is measured against the needs of the intended use and intended users in the assignment. The Self-Contained Appraisal Report option will contain a comprehensive level of information detail, but it cannot contain the sum total of the appraiser's data, analysis and experience that went into making the judgments required.

A basic requirement for **all** reports is stated in Standards Rule 2-1(b), with similar language in STANDARDS 5, 6, 8 and 10:

Each written or oral real property appraisal report must:

*contain sufficient information to enable the **intended users** of the appraisal to understand the **report properly**; (Bold added for emphasis)*

Additionally, a basic requirement for all reports is stated in Standards Rules 2-2(a), with similar language in Standards Rules 2-2(b) and (c) as well as in STANDARDS 5, 8, and 10:

*The content of a Self-Contained Appraisal Report must be consistent with the **intended use of the appraisal**.... (Bold added for emphasis)*

There are two important points to recognize in these requirements:

1. An appraiser's reporting obligations are relative to intended users (which include the client) and intended use. Reports are directed to the needs of the intended users and the

requirements associated with the intended use. Since the reporting needs associated with specific intended users and intended uses vary, report content will vary. USPAP allows for flexibility within report types.

2. The USPAP requirement is to provide sufficient information to enable the intended users to understand the **report**, not the **appraisal**. It is unreasonable to require that intended users understand the appraisal because this would entail complete documentation of the data and analysis as well as the appraiser's life experience and education that went into making the judgments required in the assignment.

Standards Rules 2-2 (a)(viii) and 8-2(a)(viii) state:

describe the information analyzed, the appraisal methods and techniques employed, and the reasoning that supports the analyses, opinions, and conclusions;

The Comment states, in part:

The appraiser must provide sufficient information to enable the client and intended users to understand the rationale for the opinions and conclusions...

This requirement is directed toward addressing the needs of the client and other intended users in understanding the rationale. The rationale is the basis for the assignment results, but does not include everything done or considered in the appraisal.

254. OWNERSHIP OF APPRAISAL REPORTS

Question: A property owner has requested a copy of an appraisal report I prepared for a lender. Who owns an appraisal report, its associated research and supporting documentation?

Response: USPAP does not specifically address who owns an appraisal report, the research necessary to produce that report and the report's supporting documentation.

Appraisal reports of all kinds are, by definition *...transmitted to the client...* As indicated in Standards Rules 2-2, 8-2, and 10-2, and further described in Advisory Opinion 12, *Use of the Appraisal Report Opinions of Standards Rules 2-2 and 8-2*, the decision as to which reporting option is appropriate for any given assignment is reached by both the appraiser and the client. However, once that decision has been competently made, USPAP does not place further responsibility upon the appraiser for the client's use of that report.

An appraiser who receives a request from any party for a copy of an appraisal report must comply with the Confidentiality section of the ETHICS RULE which, states:

An appraiser must protect the confidential nature of the appraiser-client relationship.

An appraiser must act in good faith with regard to the legitimate interests of the client in the use of confidential information and in the communication of assignment results.

The Confidentiality section of the ETHICS RULE further states:

An appraiser must not disclose: (1) confidential information or (2) assignment result to anyone other than:

- *the client;*
- *persons specifically authorized by the client;*

- *state appraiser regulatory agencies;*
- *third parties as may be authorized by due process of law; and*
- *a duly authorized professional peer review committee except when such disclosure to a committee would violate applicable law or regulation*

255. ELECTRONIC REPORT DELIVERY

Question: I am an appraiser who has been asked by my client to submit my appraisal reports to them electronically. Assuming that I have satisfied the reporting obligations in the creation of the report, what are my obligations in the use of electronic delivery systems?

Response: USPAP does not specifically address this issue, but there are general ethical obligations that are relevant. The Conduct section of the ETHICS RULE states, in part,

An appraiser:

- *must not communicate assignment results with the intent to mislead or to defraud;*
- *must not use or communicate a report that is known **by the appraiser** to be misleading or fraudulent;*
- *must not knowingly permit an employee or other person to communicate a misleading or fraudulent report; (Bold added for emphasis.)*

Communication in this instance means transmission of the report, which can occur through such mechanisms as U.S. mail, private courier service, fax, e-mail, or web portal. The appraiser's obligation is to not transmit a misleading or fraudulent report.

In the transmission of electronic reports, the appraiser's obligation is to ensure that the report that is transmitted is not misleading or fraudulent. Therefore, the appraiser needs to be familiar with the electronic report created by the software used in the assignment. The appraiser must have a sufficient understanding of the report generating software used in an assignment to avoid the communication of misleading reports. In order to comply with USPAP, the electronic report that will be sent to the client must be examined by the appraiser prior to transmission to ensure that it is not misleading or fraudulent.

An appraiser cannot control what a client or intended user does with his or her appraisal report. USPAP establishes requirements only for appraisers, not clients, intended users, or others. Once an appraisal report has been transmitted to the client, USPAP places no further responsibility on the appraiser for the client's use of that report.

256. IDENTIFICATION OF REPORT OPTION USED

Question: What does USPAP require when identifying which reporting option of STANDARD 2 is used in an appraisal assignment?

Response: STANDARD 2 allows for three types of written appraisal reports: Self-Contained Appraisal Report, Summary Appraisal Report and Restricted Use Appraisal Report.

STANDARD 2 requires that appraisers prominently state which report option is being used. In Advisory Opinion 11, *Content of the Appraisal Report Options of Standards Rules 2-2 and 8-2*, the ASB advises that *the statement should appear at or near the beginning of the report.*

Although USPAP does not dictate the specific language for identifying the report option used, a sample statement that indicates the report option used is: “This appraisal is communicated in a (Self-Contained, Summary or Restricted Use) Appraisal Report.”

257. APPRAISAL REPORT LABELING CONFUSION

Question: I am an appraiser who is still confused about the use of the various labels used in USPAP. For example, I am not certain how many approaches to value must be developed when performing a Summary Appraisal. Can you help resolve my confusion?

Response: To resolve this confusion, you must first understand that USPAP separates the process of *developing* your assignment conclusions from the process of *communicating* your results to the client and other intended users. The summary label is used in the reporting process, and is one means of communicating your assignment results. The actual label used in STANDARD 2 (for real property) and STANDARD 8 (for personal property) is Summary Appraisal Report. Standards Rules 2-2(b) and 8-2(b) describe the minimum requirements for preparing a Summary Appraisal Report, which have to do with the level of detail and amount of information communicated for that reporting option.

The number of valuation approaches you develop is part of the scope of work decision made in the development process. USPAP does not specify the number of approaches required, but leaves that decision to the appraiser. The SCOPE OF WORK RULE requires that the development process (including the number of approaches used) is sufficient to produce credible assignment results. The scope of work that you determine appropriate for an assignment is the same regardless which option you use for writing your report, Self-Contained, Summary or Restricted Use Appraisal Report.

For additional information on the appraisal reporting options, see Advisory Opinion 11, *Content of the Appraisal Report Options of Standards Rules 2-2 and 8-2*.

For more information regarding how to make the decision of how many valuation approaches to develop in an assignment, see the SCOPE OF WORK RULE, Advisory Opinion 28, *Scope of Work Decision, Performance, and Disclosure*, and Advisory Opinion 29, *An Acceptable Scope of Work*.

258. LABEL DIFFERENT FROM REPORTING OPTIONS

Question: May I label a real property appraisal report using a term other than, or in place of, Self-Contained, Summary, or Restricted Use Appraisal Report?

Response: No. The Comment to Standards Rule 2-2 states, in part:

An appraiser may use any other label in addition to, but not in place of, the label set forth in this Standard for the type of report provided.

259. IS A LETTER OF TRANSMITTAL PART OF AN APPRAISAL REPORT?

Question: I recently completed an appraisal report that included a letter of transmittal as part of my report. Some of the items required to comply with the reporting requirements of USPAP appear only in the letter of transmittal. My client states that a letter of transmittal is not part of the appraisal report, and these items must appear within the body of the report to comply with USPAP. Is my client correct?

Response: No; the client is not correct. Although a letter of transmittal is not required by USPAP, there is nothing in USPAP that prohibits making a letter of transmittal part of the appraisal report. It should be noted that USPAP does require an appraiser signing any part of an appraisal report, including a letter of transmittal, to also sign the certification.

260. COPY OF LICENSE IN APPRAISAL REPORT

Question: I have several clients that request I include a copy of my state appraisal license in each appraisal report I perform. Does USPAP permit me to do this?

Response: USPAP does not directly address issues of appraiser licensing or credentials. However, some licensing jurisdictions have laws that govern the circumstances under which a licensee may provide a copy of his or her license. If so, appraisers are required to comply with such laws in order to comply with USPAP.

261. DOES USPAP REQUIRE IDENTIFYING APPRAISAL CREDENTIALS?

Question: I am a state certified real estate appraiser and typically list my state license number directly below my signature on appraisal reports. I spoke with an appraiser in another state who said USPAP has certain requirements pertaining to identification of credentials in an appraisal report. Is this correct, does USPAP address how appraiser credentials must appear in an appraisal report?

Response: No. There are no requirements in USPAP specifying how an appraiser must identify his or her credentials in an appraisal report. That is a matter of individual state laws for state licensed or certified appraisers. There may also be specific requirements from professional appraiser organizations for appraisers who possess designations from those organizations.

262. RESTRICTED USE APPRAISAL REPORT AND THIRD PARTIES

Question: I have been asked by a client to prepare a Restricted Use Appraisal Report that he plans to provide to another intended user. Does USPAP allow me to use this report option in such a circumstance?

Response: No. The Comment to Standards Rule 2-2 states:

When the intended users do not include parties other than the client, a Restricted Use Appraisal Report may be provided.

In other words, this particular report option may only be used when the client is the only intended user.

The reason underlying this use restriction is that the client is assumed to have a sufficient level of knowledge to enable him or her to understand a report of this type. If other intended users were to be given such an abbreviated report, they could easily misunderstand it and potentially be misled.

263. APPRAISAL UPDATE REPORTING FORMAT

Question: I received a request to update an appraisal I previously completed. The original report was issued as a Self-Contained Appraisal Report. Am I required to use the same reporting format in my update?

Response: No. Advisory Opinion 3, *Update of a Prior Appraisal* states, in part:

The new report is not required to have the same level of detail as the original report – i.e., a different reporting option may be used. However, the new report must contain sufficient information to be meaningful and not misleading to the intended users.

Refer to AO-3 for further guidance.

264. ARE INSTANT MESSAGES OR TEXT MESSAGES APPRAISAL REPORTS?

Question: I perform appraisal assignments for a client who asks to be notified of my final value conclusion via instant message or text message. Is this communication to the client an appraisal report that must comply with USPAP?

Response: Yes; this communication of assignment results is considered an appraisal report. Instant messages or text messages are written communications and, for assignments involving real property, are subject to the requirements of Standards Rules 2-2.

Oral appraisal reports of real property (where assignment results are communicated by the spoken word) are subject to the requirements of Standards Rule 2-4.

265. REPORTING APPRAISAL UPDATES

Question: I recently received an assignment for an update of an appraisal. The original appraisal was reported on a commonly used single-family residential report form. Must I use this same form to report the results of the update assignment?

Response: No. Using the same form as the original report is not required for an update appraisal report. The update is a new appraisal assignment, and it may be reported in any format that is acceptable for the intended use and complies with the applicable reporting Standard (STANDARD 2 for a real property assignment). The report must contain sufficient information to be meaningful and not misleading to the intended users, but it is not required to have the same level of detail as the original report.

For additional information, refer to Advisory Opinion 3, *Update of a Prior Appraisal*.

266. FANNIE MAE UPDATE REPORT FORM 1004D/FREDDIE MAC FORM 442

I have been asked to provide an update of a previous appraisal assignment and to report the results on Fannie Mae Form 1004D/Freddie Mac Form 442. The form asks me to check yes or no in response to the question “Has the subject’s market value declined since the original appraisal date?” I have the following two questions.

Question: (1.) Does this constitute a new appraisal of the property?

Response: Yes; this is a new appraisal with a new effective date. Additional guidance can be found in Advisory Opinion 3, *Update of a Prior Appraisal*.

Question: (2.) How much of my analysis must I include in the report?

Response: Form 1004D is labeled as a Summary Appraisal Report. Therefore, the appraiser must provide a summary of the analysis conducted in the assignment.

The analysis will vary from assignment to assignment, so the information required in the report will also vary. In some cases it might be possible to summarize the analysis using the three lines provided on the form itself. If the space provided is insufficient, then the appraiser must supplement the form.

As with any written appraisal report, the appraiser is also required to include a signed certification. For Fannie Mae Form 1004D, which would be used for a real property appraisal assignment, the signed certification must be similar in content to that required in Standards Rule 2-3. If the certification included on the preprinted form does not cover all of the points required in Standards Rule 2-3, the appraiser must supplement the certification.

267. APPRAISAL REPORT CONTENT AND PROPERTY FLIPPING

Question: Is there anything I can put into a report that would protect me from being entangled in an illegal flipping scheme?

Response: There are safeguards in USPAP that pertain to reporting. It is good to review the first principle in all the reporting Standards: *to clearly and accurately set forth the appraisal in a manner that will not be misleading*. Providing candid and appropriate disclosures in the report serves to limit the appraiser’s liability and inform the client of important issues that qualify the conditions of the appraisal.

Standards Rules 2-2(a) and (b)(viii) provide good examples of appropriate disclosures that may help appraisers avoid costly mistakes and subsequent criticism (Standards Rule 2-2(c)(viii) is similar in language and intent).

When reporting an opinion of market value, a summary of the results of analyzing the subject sales, options, and listings in accordance with Standards Rule 1-5 is required. If such information is unobtainable, a statement on the efforts undertaken by the appraiser to obtain the information is required. If such information is irrelevant, a statement acknowledging the existence of the information and citing its lack of relevance is required.

These Standards Rules require that the appraiser either disclose significant information specified in Standards Rule 1-5, (if it is available in the normal course of business) or else disclose what steps were taken to obtain the information in the event that it was not obtained. The first type of

disclosure protects the appraiser from *not committing a substantial error of omission...* as required in Standards Rule 1-1(b), when the information is available and the second, if addressed properly, should convince third parties that the appraiser exercised reasonable care in the performance of the assignment.

268. LEGAL DESCRIPTION

Question: I've been told that I have to report a complete legal description for the subject property in every appraisal I perform. Is this required by USPAP?

Response: No. USPAP does not require a complete legal description for the subject property to be included in every report, since it is recognized that it is not always possible to do so. However, the reporting standards for real property, personal property, and business appraisals do have similar minimum identification requirements.

In the reporting standards for real property, Standards Rule 2-2(a)(iii), for example, appraisers are required to:

describe information sufficient to identify the real estate involved in the appraisal, including the physical and economic property characteristics relevant to the assignment;

Comment: The real estate involved in the appraisal can be specified, for example, by a legal description, address, map reference, copy of a survey or map, property sketch and/or photographs or the like. The information can include a property sketch and photographs in addition to written comments about the legal, physical, and economic attributes of the real estate relevant to the type and definition of value and intended use of the appraisal.

Similar requirements for sufficient identification of real estate subjects are also contained in Standards Rules 2-2(b)(iii) and (c)(iii).

For personal property and business or intangible assets, the requirements include similar language to present information sufficient to identify the property or assets (refer to Standards Rules 8-2(a), (b) and (c)(iii) for personal property and to Standards Rules 10-2(a) and (b)(iii) for business appraisals).

269. PROPERTY ADDRESS

Question: Does USPAP require that an address for the subject property be reported in every real property Summary Appraisal Report?

Response: No. Standards Rule 1-2(e) states, in part:

In developing a real property appraisal, an appraiser must:

- (e) identify the characteristics of the property that are relevant to the type and definition of value and intended use of the appraisal, including:*
 - (i) its location and physical, legal, and economic attributes; ...*

Additionally, Standards Rule 2-2(b) states, in part:

The content of a Summary Appraisal Report must be consistent with the intended use of the appraisal and, at a minimum:

- (iii) summarize information sufficient to identify the real estate involved in the appraisal, including the physical and economic property characteristics relevant to the assignment;*

Comment: The real estate involved in the appraisal can be specified, for example, by a legal description, address, map reference, copy of a survey or map, property sketch, and/or photographs or the like. The summarized information can include a property sketch and photographs in addition to written comments about the legal, physical, and economic attributes of the real estate relevant to the type and definition of value and intended use of the appraisal.

The appraiser must provide information sufficient to *identify the real estate involved in the appraisal*. In some cases an address, particularly a post office box or other rural address may be misleading if no other identifying information such as a legal description is provided. In other cases, an address is sufficient to meet USPAP requirements.

270. WHY REPORT SCOPE OF WORK?

Question: Why are appraisers required to report the scope of work in an appraisal, appraisal review, or appraisal consulting report?

Response: Documenting the scope of work provides the intended users with a clear understanding of the extent of the research and analyses performed. It also serves as protection for both the client and the appraiser by detailing things that were, and were not, done in the assignment.

In the SCOPE OF WORK RULE, a Comment states:

Proper disclosure is required because clients and other intended users rely on the assignment results. Sufficient information includes disclosure of research and analyses performed and might also include disclosure of research and analyses not performed.

(Note: other professions, such as engineers, have a long history of requiring the development and reporting of the scope of work in their assignments.)

271. REPORTING WORK NOT DONE IN AN ASSIGNMENT

Question: Does the report need to explain what wasn't done in an assignment?

Response: Possibly; in addition to the disclosure of research and analyses performed, disclosure of research and analyses not performed might be needed to allow users of the report to understand your scope of work. The report must explain why the cost approach, sales comparison approach or income approach was not developed. It may also be necessary to disclose other research and analysis not performed.

272. SEPARATE SCOPE OF WORK SECTION IN THE REPORT

Question: Am I required to have a separate section in my reports describing my scope of work?

Response: No. USPAP does not dictate where information must be included in reports, and the description of the scope of work performed is no exception.

The SCOPE OF WORK RULE states:

The report must contain sufficient information to allow intended users to understand the scope of work performed.

The scope of work performed may be described in one section, or throughout the report.

273. IDENTIFICATION OF INTENDED USERS IN APPRAISAL REPORTS

Question: Is an appraiser obligated to identify any intended users other than the client of an appraisal report, by name, in the report?

Response: An intended user must be identified as required by Standards Rules 2-2, 6-2, 8-2 or 10-2 (as applicable), but neither the client nor the appraiser is obligated to identify an intended user by name in the report. If identification by name is not appropriate or practical, an appraiser's client and the appraiser may identify an intended user by type. The term intended user is defined as:

the client and any other party as identified, by name or type, as users of the appraisal, appraisal review, or appraisal consulting report by the appraiser on the basis of communication with the client at the time of the assignment.

Refer to STATEMENT ON APPRAISAL STANDARDS NO. 9 (SMT-9), *Identification of Intended Use and Intended Users*, for additional information.

274. IDENTIFICATION OF THE CLIENT IN APPRAISAL REPORTS

Question: Is an appraiser required to disclose the identity of the client in an appraisal report?

Response: STATEMENT ON APPRAISAL STANDARDS NO. 9 (SMT-9), *Identification of Intended Use and Intended Users* states:

Except when specifically requested not to do so as part of the agreement with the client, an appraiser must disclose the identity of the client and any other intended users in an appraisal...report. The purpose of this reporting requirement is to 1) ensure that the client and any other intended users can recognize their relationship to the assignment and report, and 2) ensure that unintended users will not be misled by notifying them that they are neither the client nor an intended user. For example, a statement similar to the following may be appropriate:

This report is intended for use only by (identify the client) and (identify any other intended users by name or type). Use of this report by others is not intended by the appraiser.

SMT-9 also states:

If the client's identity is omitted from an appraisal report, the appraiser must (1) identify the client in the workfile, and (2) provide a notice in the appraisal report that the identity of the client has been omitted in accordance with the client's request...

Refer to SMT-9 for additional guidance.

275. DISCLOSURE OF THE INTENDED USER IN A REPORT

Question: USPAP requires that each appraisal, appraisal review, or appraisal consulting report state the intended users of the assignment results. How can one determine if the intended user statement in a report is adequate?

Response: USPAP requires disclosure of the intended users in order to ensure that:

1. The client and any other intended users can recognize their relationship to the assignment and report; and
2. Parties other than the intended users will not be misled by putting them on notice that they are neither the client nor an intended user.

Therefore, the statement regarding the intended users must be sufficient to accomplish these objectives. The appraiser is not obligated to identify an intended user by name. If identification by name is not appropriate or practical, the appraiser may identify an intended user by type.

STATEMENT ON APPRAISAL STANDARDS NO. 9 (SMT-9), *Identification of Intended Use and Intended Users*, provides an example of a statement that may be appropriate for inclusion in a report:

This report is intended for use only by (identify the client) and (identify any other intended users by name or type). Use of this report by others is not intended by the appraiser.

276. DISCLOSURE OF THE INTENDED USE IN A REPORT

Question: USPAP requires that each appraisal, appraisal review, or appraisal consulting report state the intended use of the assignment results. How can one determine if the intended use statement in a report is adequate?

Response: USPAP requires disclosure of the intended use to avoid misleading parties in possession of an appraisal, appraisal review, or appraisal consulting report. For additional clarity, one might also state that other uses are not intended. The use description provided in the statement must be specific to the assignment.

STATEMENT ON APPRAISAL STANDARDS NO. 9 (SMT-9), *Identification of Intended Use and Intended User*, provides an example of a statement that may be appropriate for inclusion in a report:

This report is intended only for use in (describe the use). This report is not intended for any other use.

277. **MULTIPLE INTENDED USES IN THE SAME APPRAISAL REPORT (NEW)**

Question: May I perform an appraisal with multiple intended uses and communicate the results in a single report with a single valuation and be in compliance with USPAP? All of the intended uses have the same type and definition of value and were performed with the same scope of work.

Response: Yes. USPAP requires the appraiser to identify the intended use of the appraisal opinions and conclusions. USPAP requires that the report states the intended use of the appraisal. Intended use is defined as:

*The **use or uses** of an appraiser's reported appraisal, appraisal review, or appraisal consulting assignment opinions and conclusions, as identified by the appraiser based on communication with the client at the time of the assignment. (Bold added for emphasis)*

Therefore an assignment may have multiple intended uses with a single value opinion in the same report as long as the uses have the same definition of value and the same scope of work.

An example with multiple intended uses with the same type and definition of value and same scope of work could include a market value appraisal being prepared for a possible donation and being prepared for a possible sale.

It should be noted that there are many circumstances when appraisers provide multiple value opinions in a single report with multiple intended uses (such as for market value, liquidation value and insurable value all in the same report). In this example, each intended use has a different type and definition of value, different scope of work, and likely will have differing conclusions.

278. **ORAL REPORTS AND RECORD KEEPING**

Question: An attorney hired me to prepare an appraisal. He asked that I not prepare a report but rather discuss my conclusions with him orally. I have done that and he concluded that my opinion will not be helpful to his client and therefore does not want a written report. What are my obligations under USPAP in this situation?

Response: Under the RECORD KEEPING RULE:

An appraiser must prepare a workfile for each appraisal, appraisal review, or appraisal consulting assignment. A workfile must be in existence prior to the issuance of any report. A written summary of an oral report must be added to the workfile within a reasonable time after the issuance of the oral report.

An appraiser must prepare a workfile for each appraisal, appraisal review, or appraisal consulting assignment. The workfile must include:

- *the name of the client and identity, by name or type, of any intended users;*
- *true copies of any written reports, documented on any type of media;*
- *summaries of all oral reports or testimony, or a transcript of testimony, **including the appraiser's signed and dated certification;***
- *all other data, information, and documentation necessary to support the appraiser's opinions and conclusions and to show compliance with this Rule and all other applicable Standards, or references to the location(s) of such other documentation; and*
- *a workfile in support of a Restricted Use Appraisal Report must be sufficient for the appraiser to produce a Summary Appraisal Report (for assignments communicated*

under STANDARDS 2 and 8) or an Appraisal Report (for assignments communicated under STANDARD 10). (Bold added for emphasis.)

The reporting of the appraisal conclusions to the attorney is an oral report. A summary of such a report, along with the appraiser's signed and dated certification needs to be included in the workfile.

279. COMMUNICATING ASSIGNMENT RESULTS WITHOUT A WRITTEN REPORT

Question: **My clients sometimes want me to communicate assignment results orally instead of issuing a written appraisal report. Does USPAP allow me to do this?**

Response: Yes. USPAP defines report as follows:

*any communication, written or **oral**, of an appraisal, appraisal review, or appraisal consulting service that is transmitted to the client upon completion of an assignment. (Bold added for emphasis.)*

Therefore, orally communicating assignment results constitutes an oral report under USPAP. The use of an oral report must be appropriate given the intended use of the assignment results, and the report must comply with the applicable reporting requirements (i.e. Standards Rules 2-4, 3-4, 5-4, 8-4 and 10-4).

The RECORD KEEPING RULE also states

An appraiser must prepare a workfile for each appraisal, appraisal review, or appraisal consulting assignment. A workfile must be in existence prior to the issuance of any report. A written summary of an oral report must be added to the workfile within a reasonable time after the issuance of the oral report.

This requires that the appraiser's workfile for an oral report must exist before the oral report is provided, and it must include a summary of the oral report and a signed and dated certification within a reasonable time after the report.

280. ORAL APPRAISAL REPORTING REQUIREMENTS

Question: **A client has asked me to complete an appraisal of a property, but she does not want me to prepare a written report. Instead, she has asked that I communicate the results of my appraisal orally. Is this allowed under USPAP? If so, what requirements would I have to follow?**

Response: Yes; USPAP allows an appraiser to provide an oral report. Standards Rules 2-4, 3-7, 5-4, 8-4, and 10-4 address the reporting requirements for oral reports. However, every appraisal, appraisal review, or appraisal consulting report must be clearly and accurately set forth in a manner that is not misleading and contain sufficient information to enable intended users to understand the report properly. Thus, the responsibility is on the appraiser to not limit the reporting to such a degree that it would be misleading.

The RECORD KEEPING RULE also has requirements related to oral appraisal reports; specifically the requirement to include in the appraiser's workfile:

summaries of all oral reports or testimony, or a transcript of testimony, including the appraiser's signed and dated certification.

In addition, the Comment to in the RECORD KEEPING RULE states:

A workfile must be in existence prior to the issuance of any report. A written summary of an oral report must be added to the workfile within a reasonable time after the issuance of the oral report.

281. WORKFILE CONTENTS FOR AN ORAL REPORT

Question: What must be in the workfile when an appraiser issues an oral report?

Response: The RECORD KEEPING RULE requires that the workfile include:

- *the name of the client and the identity, by name or type, of any other intended users;*
- *true copies of any written reports, documented on any type of media;*
- ***summaries of all oral reports or testimony, or a transcript of testimony, including the appraiser's signed and dated certification;***
- *all other data, information, and documentation necessary to support the appraiser's opinions and conclusions and to show compliance with USPAP, this Rule and all other applicable Standards, or references to the location(s) of such other documentation; and*
- *a workfile in support of a Restricted Use Appraisal Report must be sufficient for the appraiser to produce a Summary Appraisal Report (for assignments communicated under STANDARDS 2 and 8) or an Appraisal Report (for assignments communicated under STANDARD 10). (Bold added for emphasis.)*

The Comment in the RECORD KEEPING RULE also states, in part:

A workfile must be in existence prior to and contemporaneous with the issuance of any report. A written summary of an oral report must be added to the workfile within a reasonable time after the issuance of the oral report.

282. APPRAISAL REPORT FORM SOFTWARE

Question: What should I do if my appraisal form software does not address the most recent changes to USPAP?

Response: In the previous versions, as well as in the current version of USPAP, appraisers have been required to supplement an appraisal form when the form lacks required elements. This requirement can be found in the Comment to Standards Rule 2-2. The specific text states:

The report content and level of information requirements set forth in this Standard are minimums for each type of report. An appraiser must supplement a report form, when necessary, to ensure that any intended user of the appraisal is not misled and that the report complies with the applicable content requirements set forth in this Standards Rule

Appraisers must take the appropriate steps to ensure that their reports comply with the current version of USPAP.

283. PAPER COPIES OF ELECTRONICALLY TRANSMITTED REPORTS

Question: Are appraisers required by USPAP to retain a paper copy of electronically transmitted appraisal reports?

Response: No. The RECORD KEEPING RULE requires appraisers to prepare and retain written records of appraisal, appraisal review, and appraisal consulting assignments. However, the Comment states:

The workfile must include:

- *true copies of any written reports documented on any type of media (A true copy is a replica of the report transmitted to the client. A photocopy or an electronic copy of the entire report transmitted to the client satisfies the requirement of a true copy.);*
- *A photocopy or an electronic copy of the entire actual written appraisal, appraisal review, or appraisal consulting report sent or delivered to a client satisfies the requirement of a true copy.*

Therefore, a paper copy is not required.

284. APPRAISAL REPORT FORMS COMPLIANCE WITH USPAP

Question: Fannie Mae, Freddie Mac, and other governmental and private entities issue appraisal report forms. Do these forms comply with USPAP?

Response: It is the position of the ASB that appraisers comply with USPAP, not forms. Each assignment is different, and no form could cover all USPAP requirements for all assignments. Appraisal report forms are simply tools to assist in organizing the reporting of assignment results.

It is the responsibility of the appraiser to properly *develop* an appraisal, and to properly *report* the assignment results. A template or form may or may not adequately report the assignment results. It may be necessary for the appraiser to supplement a form with addenda to comply with USPAP requirements.

285. FANNIE MAE/FREDDIE MAC APPRAISAL REPORT FORMS AND USPAP COMPLIANCE

Numerous questions and comments have been presented to the Appraisal Standards Board (ASB) regarding the Fannie Mae/Freddie Mac appraisal report forms that have a revision date of November 2005. Many of the questions, which are summarized and presented below, are related to Item #23 in the appraiser's certification on report Fannie Mae Form 1004/Freddie Mac Form 70, which is titled, the Uniform Residential Appraisal Report (URAR). (The statement in item #23 on Form 1004/Form 70 also appears in the other Fannie Mae/Freddie Mac forms.) The first question is included because the answer is central to the issue raised about appraiser's certification item #23.

Question: (1.) What is meant by the term intended user in USPAP?

Response: *Intended user* is defined in USPAP as:

the client and any other party as identified, by name or type, as users of the appraisal, appraisal review, or appraisal consulting report by the appraiser on the basis of communication with the client at the time of the assignment.

Although the client provides information to the appraiser regarding the intended users, it is the appraiser who is responsible for specifying the parties he or she is identifying as intended users.

Knowing the intended users is important because USPAP requires that reports contain sufficient information to allow intended users to understand the report. Without clear knowledge of the intended users in an assignment, an appraiser cannot be certain that the report content is appropriate. Some intended users will require more information than others in order to facilitate understanding.

Furthermore, identification of the intended users is important in understanding the intended use or uses of the appraisal; different intended users may have different intended uses for the appraisal.

Question: (2.) **I have studied the recently issued revised Fannie Mae Form 1004/Freddie Mac Form 70. On that form, the lender/client is identified as the intended user. However, item #23 in the appraiser’s certification states:**

“The borrower, another lender at the request of the borrower, the mortgagee or its successors and assigns, mortgage insurers, government sponsored enterprises, and other secondary market participants may rely on this appraisal report as part of any mortgage finance transaction that involves any one or more of these parties.”

I am concerned that item #23 is not clear, and I wonder if the parties listed in Item #23 could interpret it to mean that they are also intended users. To be in compliance with USPAP, what should I do about this item in the appraiser’s certification?

Response: USPAP requires that each written appraisal report must:

...clearly and accurately set forth the appraisal in a manner that will not be misleading.

Part of satisfying this requirement is clarifying which parties are intended users. USPAP requires the appraiser to identify the intended user(s) and to state in the report who the intended users are. (See the definition of intended user, Standards Rule 1-2(a), and Standards Rule 2-2(b)(i).)

The revised Fannie Mae Form 1004/Freddie Mac Form 70 clearly states that the lender/client is the intended user. However, the language in the appraiser’s certification item #23 confuses the matter.

Therefore, in order to clearly and accurately set forth the appraisal in a manner that is not misleading, the revised Fannie Mae Form 1004/Freddie Mac Form 70, and other Fannie Mae/Freddie Mac forms for other real property categories, require supplementation to clarify which parties the appraiser is identifying as intended users. As stated in USPAP:

An appraiser must supplement a report form, when necessary, to ensure that any intended user of the appraisal is not misled...

Part of not misleading the intended users is ensuring that they know who they are.

Question: (3.) **Does the ASB consider item #23 in the appraiser’s certification on report the Fannie Mae Form 1004/Freddie Mac Form 70 confusing?**

Response: The statement that the parties listed “...may rely on this appraisal report as part of any mortgage finance transaction that involves any one or more of these parties” is subject to various interpretations.

First, from a practical standpoint, there is little distinction between parties who use the report and parties who rely on the report. It is difficult to determine the difference between those parties given permission to rely on the appraisal report (from the Fannie Mae/Freddie Mac report forms) and those parties identified as users of the appraisal report (from the USPAP definition of intended users).

Another matter of confusion is the meaning of the word *may* in the phrase “may rely on.” One interpretation could be that the appraiser is granting permission. This permission for the parties to rely on the report suggests that they are intended users. Another interpretation could be that the appraiser is simply acknowledging the possibility that another party might choose to rely on the report, even if that party is not an intended user. This possibility has always existed; the appraiser cannot control to whom the client provides copies of the report.

Question: (4.) **What should an appraiser do if the parties listed in appraiser’s certification item #23 are determined by the appraiser to be intended users? What if the appraiser determines they are not intended users?**

Response: First, if the appraiser intends any of the parties listed in appraiser’s certification item #23 to be intended users, the report must state that fact, and the appraiser must comply with the USPAP requirements associated with these other intended users. For example, further supplementation might be necessary to comply with Standards Rule 2-1(b), requiring that the appraisal report must:

...contain sufficient information to enable the intended users of the appraisal to understand the report properly...

Conversely, if the appraiser does not intend the parties listed in appraiser’s certification item #23 to be intended users, the report must be supplemented to clearly explain this. For example, as indicated in USPAP STATEMENT ON APPRAISAL STANDARDS NO. 9 (SMT-9), *Identification of Intended Uses and Intended Users*, a statement similar to the following may be appropriate:

This report is intended for use only by (identify the client and any other intended users). Use of this report by others is not intended by the appraiser.

Question: (5.) **But how can I supplement the Fannie Mae/Freddie Mac appraisal report forms? Fannie Mae and Freddie Mac prohibit supplementing the certification regarding anything material.**

Response: The ASB cannot comment on Fannie Mae or Freddie Mac policies. However, USPAP requires that the appraiser supplement an appraisal report form if the form is not adequate. As stated in STANDARD 2 of USPAP:

*An appraiser **must** supplement a report form, when necessary, to ensure that any intended user of the appraisal is not misled and that the report complies with the applicable content requirements set forth in the Standards Rules. (Bold added for emphasis)*

Each assignment is different, and no form could cover all USPAP requirements for all assignments. Appraisal report forms are simply tools to assist in organizing the reporting of assignment results.

It is the responsibility of the appraiser to properly *develop* an appraisal and to properly *report* the assignment results. A template or form may or may not adequately report the assignment results.

286. STANDARDS, STANDARDS RULES, AND REPORTING AN APPRAISAL

Question: Which Standards and Standards Rules apply to reporting an appraisal?

Response: Reporting an appraisal is one part of the development and reporting steps. STANDARD 2 and Standards Rules 2-1 through 2-4 apply to reporting a real property appraisal. Standards Rules 6-8 and 6-9 apply to a written mass appraisal report. STANDARD 8 and Standards Rules 8-1 through 8-4 apply to reporting a personal property appraisal. STANDARD 10 and Standards Rules 10-1 through 10-4 apply to reporting a business appraisal.

287. APPLICATION OF APPRAISAL REPORTING REQUIREMENTS (NEW)

Question: If an appraiser is bound by USPAP for a particular assignment, when must the appraiser comply with the USPAP appraisal reporting requirements?

Response: Whenever a value opinion is communicated, compliance with USPAP's appraisal reporting requirements is required.

It may seem obvious in many cases that an appraiser must abide by the appraisal reporting requirements. However, in other cases it is not as obvious, such as the following examples:

- Selecting and providing a client with comparable sales for a known property is an appraisal assignment as defined by USPAP.
- Informing a property owner that their property tax assessment is too high is an appraisal report as defined in USPAP
- Providing an opinion of market rent is an appraisal report as defined in USPAP.
- Providing an opinion of the most probable selling price for a homeowner is an appraisal report as defined in USPAP.
- Preparing, analyzing and communicating the results of an automated valuation model (AVM) for a property is an appraisal assignment.

It is important to remember that the applicability of USPAP is not affected by the amount or the lack of a fee.

288. DISCOUNTED CASH FLOW (DCF)

Question: I am appraising a property that will require a discounted cash flow (DCF) analysis. Are there any special requirements in USPAP for this?

Response: STATEMENT ON APPRAISAL STANDARDS NO. 2 (SMT-2), *Discounted Cash Flow Analysis* contains a number of requirements related to performing a DCF in the appraisal of real property.

The following outlines the conclusions at the end of this Statement:

- *DCF analysis is an additional tool available to the appraiser and is best applied in developing value opinions in the context of one or more other approaches.*
- *It is the responsibility of the appraiser to ensure that the controlling input is consistent with market evidence and prevailing market attitudes.*
- *Market value DCF analyses should be supported by market-derived data, and the assumptions should be both market- and property-specific.*
- *If using commercial software the appraiser should cite the name and version of the software and provide a brief description of the methods and assumptions inherent in the software.*
- *DCF accounts for and reflects those items and forces that affect the revenue, expenses, and ultimate earning capacity of real estate and represents a forecast of events that would be considered likely within a specific market.*
- *The results of DCF analysis should be tested and checked for errors and reasonableness.*
- *Standards Rule 1-1(b) states that the appraiser must not commit a substantial error of omission or commission that significantly affects the appraisal.*

Since Statements have the full weight of a Standards Rule, their requirements must be adhered to.

289. CONTENT OF RESTRICTED USE APPRAISAL REPORTS

Question: I have been asked to provide a Restricted Use Appraisal Report, but I would like to be very descriptive in parts of the report. Does USPAP preclude appraisers from including detailed analysis in a Restricted Use Appraisal Report?

Response: No. USPAP prescribes the minimum content requirements for all three reporting options, Self-Contained Appraisal Report, Summary Appraisal Report, and Restricted Use Appraisal Report. An appraiser is always free to add to the minimum requirements.

290. APPRAISER QUALIFICATIONS IN REPORT

Question: I've seen several appraisal reports that include a copy of the appraiser's résumé, professional qualifications, or curriculum vitae (CV). Does USPAP require an appraisal report to include the appraiser's qualifications?

Response: No. Although certain professional appraiser organizations or users of appraisal services might require the report to include the appraiser's qualifications, it is not a USPAP requirement.

291. PROVIDING A DRAFT OF A REPORT

Question: My client has asked that I provide a draft of my appraisal report prior to issuing the report in final form. Is this permitted under USPAP?

Response: USPAP does not explicitly define or address drafts of reports. When clients, other intended users, and appraisers use the term draft, they may mean many different things, from preliminary spreadsheets to a written document that contains all that will be in the final report except it is labeled as draft and does not contain signatures. Report drafts have traditionally been part of certain types of appraisal practice but have never been considered acceptable in other types of appraisal practice.

State-regulated appraisers should be aware of applicable state laws and regulations. Many laws define a report as “any communication, written or oral, of an appraisal.”

Whatever a draft may be in a particular context, it would always be part of appraisal practice, because it is a valuation service provided by an appraiser. When performing a service that is considered appraisal practice, but for which there are no applicable Standards Rules, an appraiser must still comply with the portions of USPAP that apply generally to appraisal practice. These include the DEFINITIONS, the PREAMBLE, the ETHICS RULE, the COMPETENCY RULE, and the JURISDICTIONAL EXCEPTION RULE.

The second sentence of the PREAMBLE states: *It is essential that appraisers develop and communicate their analyses, opinions, and conclusions to intended users of their services in a manner that is meaningful and not misleading.* Additionally, the Conduct section of the ETHICS RULE states:

An appraiser:

- *must not communicate assignment results with the intent to mislead or to defraud;*
- *must not use or communicate a report that is known by the appraiser to be misleading or fraudulent;*

Therefore, if an appraiser communicates with intended users prior to completion of an assignment, the communication must not be misleading.

The purpose of issuing a draft cannot be to allow the client to improperly influence the appraiser.

292. DEVELOPING AN UNNECESSARY VALUATION APPROACH

Question: I have a client requesting that the cost approach be included in every appraisal assignment, including those where I feel the cost approach may not yield meaningful results. I am concerned that by complying with the client’s request I may be providing a misleading appraisal report. How can I comply with USPAP and satisfy the client at the same time?

Response: Performing a cost approach that may not yield a meaningful indication of value does not result in a misleading appraisal report if the appraiser properly addresses the applicability and suitability of the approach in the report. Many appraisers address this in the reconciliation by including statements such as, “The cost approach was included solely at the request of the client; it has been given no weight in arriving at the final opinion of value because”

See Advisory Opinion 28, *Scope of Work Decision, Performance, and Disclosure*, for further guidance.

APPRAISAL REVIEW

293. WHEN DOES STANDARD 3 APPLY?

Question: I am an appraiser and my practice includes requests to comment on a wide range of valuation work performed by others. At various times this work is presented as an appraisal report, appraisal consulting report, consulting report, market data summary, or even as a broker's price opinion. When does STANDARD 3 apply?

Response: The answer to this question lies in the definition of appraisal review:

the act or process of developing and communicating an opinion about the quality of another appraiser's work that was performed as part of an appraisal, appraisal review, or appraisal consulting assignment.

For this question, the key features of an appraisal review are:

- the work under review was performed by an appraiser, and
- the work under review was performed as part of an appraisal, appraisal review, or appraisal consulting assignment.

Assignments involving commenting on the quality of appraisal reports, appraisal review reports and appraisal consulting reports are appraisal reviews. However, STANDARD 3 only applies to the review of work that was performed in an appraisal, appraisal review, or real property appraisal consulting assignment.

Assignments related to consulting reports, market data summaries, and broker's price opinions are not appraisal reviews. Even when the work under examination is performed by an appraiser, evaluating these types of work is not part of an appraisal review.

However, even if the service is not an appraisal review, the portions of USPAP that apply to appraisal practice, (i.e., DEFINITIONS, the PREAMBLE, the ETHICS RULE, the COMPETENCY RULE and the JURISDICTIONAL EXCEPTION RULE) would apply because you are acting as an appraiser.

294. GEOGRAPHIC COMPETENCY IN APPRAISAL REVIEWS

Question: I have a client who has asked me to perform a desk review on an appraisal report for a property located in a different state. I have no knowledge of the real estate market in that state and have never even stepped foot there. Can I perform a USPAP-compliant appraisal review on this report?

Response: Yes. If you are engaged to determine whether or not the appraisal report under review complies with certain guidelines or standards, geographic competence is not typically relevant. Alternatively, review assignments that include evaluating the selection and adjustment of comparable sales typically require geographic competence. As in all assignments, an appraiser must identify the scope of work required for the assignment and determine if he or she has the knowledge and experience to complete the assignment competently.

295. POST-VALUATION DATE INFORMATION IN APPRAISAL REVIEWS

Question: Can post-valuation date information be used to impeach or impugn appraisals and appraisers?

Response: No. The Comment to Standards Rule 3-2(h) states:

Information that should have been considered by the original appraiser can be used by the reviewer in developing an opinion as to the quality of the work under review.

Information that was not available to the original appraiser in the normal course of business may also be used by the reviewer; however, the reviewer must not use such information in the reviewer's development of an opinion as to the quality of the work under review.

For additional guidance, see STANDARD 3 and Advisory Opinion 20, *An Appraisal Review Assignment That Includes the Reviewer's Own Opinion of Value*.

296. REVIEWER DISAGREES WITH VALUE CONCLUSION

Question: In performing an appraisal review, a reviewer disagrees with the value conclusion in the original appraisal. What is the correct action the reviewer should take according to USPAP?

Response: STANDARD 3 addresses the development and reporting of an appraisal review. The Comment to Standards Rule 3-2(c) states that the reviewer may express his or her own opinion of value. When disagreeing with the value conclusion in the work under review, the reviewer is required to fully develop a value opinion under the applicable development Standard (STANDARD 1, 3, 4, 6, 7 or 9) and clearly set forth the basis for his or her conclusions. Standards Rule 3-4 and 3-5 address the reporting of the reviewer's opinion of value, (i.e., an appraisal) within the appraisal review report. The reporting requirements of STANDARD 2, 5, 6, 8 or 10 do not apply.

However, the Comment to Standards Rule 3-3(c) states:

When the appraisal review scope of work includes the reviewer developing his or her own opinion of value, review opinion or real property appraisal consulting conclusion, the following apply:

- *The reviewer's scope of work in developing his or her own opinion of value, review opinion, or real property appraisal consulting conclusion may be different from that of the work under review.*
- *The effective date of the appraisal, appraisal review, or appraisal consulting opinions and conclusions may be the same or different from the effective date of the work under review.*
- *The reviewer is not required to replicate the steps completed by the original appraiser. Those items in the work under review that the reviewer concludes are credible can be extended to the reviewer's development process on the basis of an extraordinary assumption. Those items not deemed to be credible must be replaced with information or analysis developed in conformance with STANDARD 1, 3, 4, 6, 7, or 9, as applicable, to produce credible assignment results.*

And, the Comment to Standards Rule 3-2(h) states:

Information that should have been considered by the original appraiser can be used by the reviewer in developing an opinion as to the quality of the work under review.

Information that was not available to the original appraiser in the normal course of business may also be used by the reviewer; however, the reviewer must not use such information in the reviewer's development of an opinion as to the quality of the work under review.

Refer to Advisory Opinion 20 (AO-20), *An Appraisal Review Assignment that Includes the Reviewer's Own Opinion of Value*, for additional guidance.

297. REVIEWER CONCURS WITH VALUE CONCLUSION

Question: I am performing a review of a real property appraisal and my client has asked me to give my opinion of value, even if I agree with the value in the appraisal. Does my concurrence constitute an appraisal? If so, what do I need to do to comply with USPAP?

Response: Yes. If you concur with the value in the report, it does constitute an appraisal by the reviewer. Standards Rule 3-3(c) states:

When the scope of work includes the reviewer developing his or her own opinion of value, review opinion, or real property appraisal consulting conclusion, the reviewer must comply with the Standard applicable to the development of that opinion.

- (i) *The requirements of STANDARDS 1, 6, 7, and 9 apply to the reviewer's opinion of value for the property that is the subject of the appraisal review assignment.*

The Comment to Standards Rule 3-3(c) states:

These requirements apply to:

- *The reviewer's own opinion of value when the subject of the review is the product of an appraisal assignment;*

These requirements apply whether the reviewer's own opinion:

- *Concurs with the opinions and conclusions in the work under review; or*
- *differs from the opinion and conclusions in the work under review.*

When the appraisal review scope of work includes the reviewer developing his or her own opinion of value, review opinion or real property appraisal consulting conclusion, the following apply:

- *The reviewer's scope of work in developing his or her own opinion of value, review opinion, or real property appraisal consulting conclusion may be different from that of the work under review.*
- *The effective date of the appraisal, appraisal review, or appraisal consulting opinions and conclusions may be the same or different from the effective date of the work under review.*
- *The reviewer is not required to replicate the steps completed by the original appraiser. Those items in the work under review that the reviewer concludes are credible can be extended to the reviewer's development process on the basis of an extraordinary assumption. Those items not deemed to be credible must be replaced*

with information or analysis developed in conformance with STANDARD 1, 3, 4, 6, 7, or 9, as applicable, to produce credible assignment results.

You should be sure that your scope of work clearly includes the requirement to develop your own opinion of value (i.e., develop an appraisal).

The Comment to Standards Rule 3-3(c) shows the steps that must be taken when the scope of work includes the reviewer expressing his or her own opinion of value. One of these requirements is that you must satisfy the applicable development standard. Specifically, whether you concur or disagree with the value in the appraisal being reviewed, you would extend to your development process those items in that appraisal that you conclude are credible and in compliance with STANDARD 1, in this case. This is accomplished on the basis of an extraordinary assumption. Those items not deemed to be credible or in compliance must be replaced with information or analysis by the reviewer.

Additional advice is contained in Advisory Opinion 20 (AO-20), *An Appraisal Review Assignment that Includes the Reviewer's Own Opinion of Value*.

298. APPRAISAL REVIEW AND STATE APPRAISER BOARDS

Question: Is a reviewer permitted by USPAP to file a complaint with a state appraiser board without the consent of his or her client?

Response: It is the opinion of the ASB that a reviewer may, absent any higher precedent law or regulation, file a complaint with a state appraiser board without the consent of his or her client.

The Confidentiality section of the ETHICS RULE states:

An appraiser must protect the confidential nature of the appraiser-client relationship.

The Confidentiality section continues:

An appraiser must not disclose: (1) confidential information or (2) assignment results to anyone other than:

- *the client;*
- *persons specifically authorized by the client;*
- ***state appraiser regulatory agencies;***
- *third parties as may be authorized by due process of law; and*
- *a duly authorized professional peer review committee except when such disclosure to a committee would violate applicable law or regulation. (Bold added for emphasis.)*

299. READING APPRAISAL REPORTS

Question: I recently completed an appraisal and forwarded the report to the client. After receiving the report the client called and stated that they have another appraisal that was recently completed and the values differ significantly. They asked if I would look over the other report and point out the primary differences. Does this assignment constitute an appraisal review?

Response: No. In this case the client is not asking you to assess the quality of the other appraisal or your opinion of its conclusions. Since you are only noting the differences in the two appraisals you are not performing an appraisal, appraisal review, or appraisal consulting assignment.

300. REVIEWING TWO APPRAISALS ON THE SAME PROPERTY

Question: **My client, a government agency, has obtained two appraisals of the same real property, and has asked me to review both and reconcile them to a single value. Can I perform this assignment under USPAP?**

Response: Yes; you can perform this assignment under USPAP. The situation you describe constitutes a real property appraisal review assignment. STANDARD 3 addresses the development and reporting of a real property appraisal review assignment. In this case, you would apply the specific appraisal review requirements of Standards Rule 3-1 and Standards Rule 3-2 to both appraisals being reviewed, and provide your own opinion of value in accordance with Standards Rule 3-3(c) and Standards Rule 3-5(i).

In this type of situation, it would be appropriate to include the result of your review of both appraisals and your own appraisal opinion within the same appraisal review report, since these would all have to be addressed in the same report to be understood properly and thus not be misleading. A single signed certification would be provided, in accord with Standards Rule 3-6.

For additional guidance, refer to Advisory Opinion 20 (AO-20), *An Appraisal Review Assignment that Includes the Reviewer's Own Opinion of Value*.

301. MUST A REVIEW APPRAISER BE LICENSED OR CERTIFIED IN THE STATE JURISDICTION WHERE THE SUBJECT PROPERTY IS LOCATED?

Question: **Does a review appraiser have to be licensed or certified in the state where the subject property is located?**

Response: Appraiser credentialing requirements are not covered by USPAP. However, since this question is often asked, we have provided the following response from the Appraisal Subcommittee (ASC):

“Included in ASC Policy Statement 5 is the ASC’s position on when an out-of-state review appraiser must obtain a credential for purposes of performing a technical review. The ASC has concluded that for federally related transactions, so long as the review appraiser does not perform the technical review in the state within which the property is located, and so long as the review appraiser is certified or licensed by another state, that appraiser need not be registered for temporary practice or otherwise credentialed by the state agency where the subject property is located. With that said, state law may be more restrictive than federal law and may require a temporary practice permit or other credential. It is therefore imperative to consult with the state where the property is located.”

ASC Policy Statements may be downloaded by visiting the following ASC website below.
<https://www.asc.gov/Legal-Framework/ASC-Policy-Statements/PolicyStatements.aspx>.

302. REVIEW REPORT ON MULTIPLE APPRAISAL REPORTS

Question: I have been asked to review multiple appraisal reports and to report my findings in one appraisal review report. Does USPAP permit this?

Response: Yes. A single appraisal review assignment can include the review of several appraisal reports, with the assignment results presented in one appraisal review report.

303. APPRAISAL REVIEW FOR A STATE APPRAISER BOARD

Question: I am a state-certified appraiser who serves on the appraisal review panel for our state's appraisal licensure and certification board. The state administrator has asked me to review an appraisal report. The appraiser that prepared the report is the subject of a complaint that was recently filed. The purpose of the review is to develop and state my opinion as to the quality of the work in comparison to the applicable requirements in USPAP, state law, and regulations. My state does not exempt reviewers who are state licensed or certified appraisers from compliance with USPAP when performing such reviews. Do I have to follow STANDARD 3 in this assignment?

Response: Yes. Under the circumstances you describe, you must follow all the applicable requirements of STANDARD 3. In this specific situation, just because the intended user and intended use are related to enforcement does not mean such a review assignment would be treated or accomplished any differently.

However, some states have laws or regulations that exempt appraisal review work of this type from USPAP. An appraiser performing such an assignment should discuss the assignment with the client and carefully review the applicable state law and regulation to ensure no misunderstanding about whether the appraiser's compliance with a part or parts of USPAP is, in fact, precluded; or whether a jurisdictional exception results in a part or parts of USPAP, such as STANDARD 3, not being applicable.

304. REVIEWING AN APPRAISAL REVIEW REPORT

Question: An appraiser was recently asked to review another appraiser's appraisal review report. Must the appraiser comply with STANDARD 3 in completing this assignment?

Response: Yes; the appraiser must comply with STANDARD 3 in this assignment. STANDARD 3 states:

In developing an appraisal review assignment, an appraiser acting as a reviewer must identify the problem to be solved, determine the scope of work necessary to solve the problem, and correctly complete research and analyses necessary to produce a credible appraisal review. In reporting the results of an appraisal review assignment, an appraiser acting as a reviewer must communicate each analysis, opinion, and conclusion in a manner that is not misleading.

The Comment to this Standard goes on to state, in part:

*STANDARD 3 is directed toward the substantive aspects of developing a credible opinion of the quality of another appraiser's work that was performed as part of an appraisal, **appraisal review**, or real property appraisal consulting assignment. (Bold added for emphasis)*

Simply stated, appraisal review encompasses more than just the review of another appraiser's appraisal. It is *the act or process of developing and communicating an opinion about the quality of another appraiser's work.* (See the definition of 'appraisal review')

305. SCOPE OF WORK IN APPRAISAL REVIEW REPORTS

Question: USPAP requires appraisers to include a description of the scope of work in each appraisal report, the detail of which varies by reporting option. Is there a similar requirement for appraisal review reports?

Response: Yes. Standards Rule 3-5, states:

The content of an Appraisal Review Report must be consistent with the intended use of the appraisal review and, at a minimum:

(g) state the scope of work used to develop the appraisal review;

306. REVIEWING A PORTION OF AN APPRAISAL REPORT

Question: I was recently asked to review an appraisal report and limit my review to the income approach to value. Is such a limitation acceptable?

Response: Yes. USPAP does not require the reviewer to review the entire report. The Comment to Standards Rule 3-2(d) states:

The subject of an appraisal review assignment may be all or part of a report, a workfile, or a combination of these (Bold added for emphasis.)

307. CHANGING THE VALUE OPINION WITHOUT THE APPRAISER'S CONSENT

Question: Is it ethical for an appraiser, acting as a reviewer, to change the reported value opinion in the original appraiser's work without the knowledge or consent of the original appraiser?

Response: No. Standards Rule 3-4 states:

*Each written or oral Appraisal Review Report **must be separate from the work under review** (Bold added for emphasis.)*

In addition, simply changing the original appraisal report, in any way, without the consent of original appraiser would be a violation of the Conduct section of the ETHICS RULE that states, in part,

An appraiser:

- *must not use or communicate a report that is known **by the appraiser** to be misleading or fraudulent;*
- *must not knowingly permit an employee or other person to communicate a misleading or fraudulent report.* (Bold added for emphasis.)

308. REVIEWER'S OWN OPINION OF VALUE AND SCOPE OF WORK

Question: In an appraisal review assignment that includes the reviewer's own opinion of value, is the reviewer required to use the same scope of work as the original appraiser?

Response: No. The Comment to Standards Rule 3-3(c) states, in part:

When the appraisal review scope of work includes the reviewer developing his or her own opinion of value, review opinion or real property appraisal consulting conclusion, the following apply:

- *The reviewer's scope of work in developing his or her own opinion of value, review opinion, or real property appraisal consulting conclusion may be different from that of the work under review.*
- *The effective date of the appraisal, appraisal review, or appraisal consulting opinions and conclusions may be the same or different from the effective date of the work under review.*
- *The reviewer is not required to replicate the steps completed by the original appraiser. Those items in the work under review that the reviewer concludes are credible can be extended to the reviewer's development process on the basis of an extraordinary assumption. Those items not deemed to be credible must be replaced with information or analysis developed in conformance with STANDARD 1, 3, 4, 6, 7, or 9, as applicable, to produce credible assignment results.*

For example, the scope of work in the original appraisal may have included an interior and exterior inspection of the subject property, and the scope of work for the appraisal review may include only an exterior inspection or no inspection at all.

309. DISCREDITING THE ORIGINAL APPRAISER'S WORK

Question: Recently one of my appraisal reports was reviewed. The review report contained information that could not have been available to me at the time I completed my appraisal report. The reviewer used this additional information to discredit my opinion of value. Is this appropriate?

Response: No. The Comment to Standards Rule 3-2(h) allows a reviewer to use additional information,

*Information that was not available to the original appraiser in the normal course of business may also be used by the reviewer; **however, the reviewer must not use such information in the reviewer's development of an opinion as to the quality of the work under review.*** (Bold added for emphasis)

310. REVIEWER CITATION OF USPAP NON-COMPLIANCE

Question: If a review appraiser concludes that an appraisal report is unacceptable, does the reviewer need to cite specific requirements in USPAP that were not fulfilled appropriately?

Response: No, but the review appraisal report must include the reasons for the reviewer's conclusion. When the scope of work requires the review appraiser to evaluate compliance with relevant USPAP requirements, it is appropriate to analyze compliance or non-compliance with USPAP. However, USPAP does not require a reviewer to determine that the subject of an appraisal review complies with USPAP.

311. REVIEW APPRAISER BIAS

Question: An appraiser receives a request to review an appraisal; however, the reviewer has previously appraised the same property. Does the reviewer's prior experience with the property create a bias that then precludes an objective review?

Response: No. Prior appraisal experience with the subject of the work under review might be considered an asset and may have contributed to the reviewer's selection for the assignment. Before accepting any assignment, an appraiser must be certain that he or she will be able to attest in the certification that the assignment results are impartial and unbiased. If the performance of the prior appraisal assignment creates a predisposition regarding appropriate and reasonable assignment results, the appraiser should decline the appraisal review assignment.

In addition, a reviewer with prior experience with the property should be aware that the Conduct section of the ETHICS RULE states:

If known prior to accepting an assignment, and/or if discovered at any time during the assignment, an appraiser must disclose to the client, and in the subsequent report certification:

- any current or prospective interest in the subject property or parties involved; and
- any services regarding the subject property performed by the appraiser within the three year period immediately preceding acceptance of the assignment, as an appraiser or in any other capacity.

312. IS COMPLIANCE WITH STANDARD 3 REQUIRED WHEN SUBMITTING A COMPLAINT?

Question: I am a real property appraiser. I want to submit a complaint regarding an appraisal report to my state appraiser regulatory agency. I would like to express my opinions and comments about the quality of the appraisal report in a cover letter. Am I obligated to comply with STANDARD 3 regarding my opinions and comments regarding the appraisal? If so, who is my client?

Response: No, you are not required to comply with STANDARD 3. Because the individual filing the complaint is acting as an appraiser, USPAP applies. However, because there is no client, there is no assignment and so STANDARD 3 does not apply. Therefore, the appraiser making the complaint would be obligated to comply with the portions of USPAP that apply generally to

appraisal practice (i.e. DEFINITIONS, the PREAMBLE, the ETHICS RULE, the COMPETENCY RULE, and the JURISDICTIONAL EXCEPTION RULE).

313. UNIFORM ACT AND THE REVIEW OF LOW VALUE ACQUISITION APPRAISAL REPORTS

Question: I am a review appraiser for a government agency that is subject to the provisions of The Uniform Relocation Assistance and Real Property Acquisitions Act of 1970, as Amended (commonly known as, the Uniform Act), and its implementing regulation, 49 CFR Part 24. There is a provision in this Federal regulation that allows an acquiring agency to adopt an appraisal review reporting process, in cases of low value acquisitions, that may be as simple as the review appraiser stamping such an appraisal report as “Approved,” and signing and dating that action.

This process is intended to be used only in certain acquisitions, such as a partial acquisition for a highway project – and then only in those that are very minor in their impact to the subject properties and which clearly do not result in legally compensable damages to the remainders or any change in highest and best use. Examples of these appraisal reports might be those performed to value easement areas and/or very minor fee simple acquisitions.

In these cases, this federal regulation obviously requires much less than is typically required in STANDARD 3 of USPAP.

How does the ASB characterize a review appraiser’s simple approval in these instances, as a jurisdictional exception or an assignment condition?

Response: When it applies, 49 CFR Part 24 is an assignment condition. There is no jurisdictional exception because the Uniform Act and its implementing regulation (49 CFR Part 24) allows the use of this simplified review process in cases of low value acquisitions but does not require it. A jurisdictional exception is created only when compliance with USPAP is precluded by a requirement of law or regulation. The Uniform Act does not mandate the use of this simplified review process in cases of low value acquisitions, therefore it is not a requirement of law or regulation, consequently, the simplified review process does not preclude compliance with USPAP.

USPAP STANDARD 3 applies to appraisal review assignments and provides for flexibility in the scope of work for the review. Based on the intended use and purpose of the appraisal review, the reviewer can determine an appropriate scope of work necessary to develop credible assignment results.

In the review of low value acquisition appraisal reports under the Uniform Act, the simplified appraisal review process must produce credible assignment results in light of the intended use. If this USPAP requirement is satisfied, the appraisal review process is acceptable.

The USPAP requirements for an appraisal review assignment also allow flexibility in reporting the results of an appraisal review assignment. The format of the appraisal review report is not addressed by USPAP, but Standards Rule 3-4 states:

*Each written or oral Appraisal Review Report **must be separate from the work under review and must:** (Bold added for emphasis.)*

The application of a stamp to the appraisal report under review does not comply with this reporting requirement. The review appraiser must ensure that the content of the review report complies with the requirements of Standards Rule 3-2.

314. EFFECTIVE DATE THAT DIFFERS FROM THE WORK UNDER REVIEW

Question: In an appraisal review assignment for which the reviewer develops his or her own opinion of value, is it permissible for the reviewer to use an effective date that differs from the work under review?

Response: Yes. The Comment to Standards Rule 3-3(c) states, in part:

When the appraisal review scope of work includes the reviewer developing his or her own opinion of value, review opinion or real property appraisal consulting conclusion, the following apply:

- *The reviewer's scope of work in developing his or her own opinion of value, review opinion, or real property appraisal consulting conclusion may be different from that of the work under review.*
- ***The effective date of the appraisal, appraisal review, or appraisal consulting opinions and conclusions may be the same or different from the effective date of the work under review.*** (Bold added for emphasis.)

315. ADDITIONAL CERTIFICATION IN AN APPRAISAL REVIEW REPORT

Question: I recently reviewed an appraisal report. As part of the assignment I developed an opinion of value that was different from the value in the appraisal report. I understand that I must provide a signed certification for the review pursuant to Standards Rule 3-6. However, the language in Standards Rule 3-5 seems to suggest that I am also required to prepare an additional certification to comply with Standards Rule 2-3. Are two certifications necessary?

Response: No, you are not required to provide two certifications in an appraisal review assignment that includes reporting your own value opinion.

This is addressed in the Comment to Standards Rule 3-5(i), which states:

*The reviewer may include his or her own opinion of value, review opinion, or appraisal consulting conclusion related to the work under review within the appraisal review report itself without preparing a separate report. However, data and analyses provided by the reviewer to support a different opinion or conclusion must match, at a minimum, **except for the certification requirements**, the reporting requirements for a:* (Bold added for emphasis.)

- *Summary Appraisal Report for a real property appraisal (Standards Rule 2-2(b));*
- *Summary Appraisal Report for a personal property appraisal (Standards Rule 8-2(b));*
- *Appraisal Review Report for an appraisal review (Standards Rule 3-5);*
- *Appraisal Consulting Report for real property appraisal consulting (Standards Rule 5-2);*
- *Mass Appraisal Report for mass appraisal (Standards Rule 6-8); and*

- *Appraisal Report for business appraisal (Standards Rule 10-2(a)).*

The Comment underscores that whenever a reviewer provides a value conclusion different from the value opinion in the report under review, it is only the data and analyses provided by the reviewer that must be consistent with the applicable reporting Standard.

OTHER SERVICES

316. VALUE OPINION IN AN APPRAISAL CONSULTING ASSIGNMENT

Question: May an appraiser express his or her own opinion of value in an appraisal consulting assignment, or must the appraiser use an opinion of value developed and reported by another appraiser?

Response: Either case may be acceptable in an appraisal consulting assignment depending on the scope of work. In an appraisal consulting assignment, an appraiser may develop and report his or her own opinion of value as part of the appraisal consulting assignment. The Comment to STANDARD 4, which addresses real property appraisal consulting, development, states, in part:

In some assignments, the opinion of value may originate from a source other than the consulting appraiser. In other assignments, the consulting appraiser may have to develop the opinion of value as a step in the analyses leading to the assignment results.

An opinion of value or an opinion as to the quality of another appraiser's work cannot be the purpose of an appraisal consulting assignment. Developing an assignment for those purposes is an appraisal or an appraisal review assignment, respectively. Misrepresenting the purpose of an assignment performed under this Standard is a violation of the ETHICS RULE.

Additionally, if the appraiser develops an opinion of value as part of an appraisal consulting assignment, the appraisal component must be reported in conformance with the applicable sections of STANDARD 2. The Comment to Standards Rule 5-2(g) states, in part:

If an opinion of value was developed by the consulting appraiser, the appraisal consulting report must include the information required to comply with Standards Rule 2-2(a) or (b)(ii) through (x). Standards Rule 2-2(c)(ii) through (x) is also permitted if the client is the only intended user of the assignment results.

317. VALUATION SERVICE INVOLVING ADVOCACY

Question: A client feels that her property is over assessed by the county. She's asked me to perform a tax consulting service that involves advocacy for her position and I'd like to charge her on a contingency fee basis. This assignment would not include an appraisal. I have two questions: Is this service allowed under USPAP? If not, can I perform this assignment outside of USPAP?

Response: You may not perform this assignment under USPAP. An appraiser, in appraisal practice, may not be an advocate. The Conduct section of the ETHICS RULE states:

An appraiser must perform assignments with impartiality, objectivity, and independence, and without accommodation of personal interests.

An appraiser:

- *must not perform an assignment with bias;*

- *must not advocate **the cause or interest** of any party or issue;* (Bold added for emphasis.)

Appraisal practice is defined as:

valuation services performed by an individual acting as an appraiser, including but not limited to appraisal, appraisal review, or appraisal consulting.

Furthermore, none of the certifications in USPAP allow any bias, contingent compensation related to assignment results, or direction in value that favors the cause of the client.

Absent any law or regulation to the contrary, you may complete this assignment outside of USPAP, as long as you are very clear about your role. The ETHICS RULE also states,

An appraiser:

must not misrepresent his or her role when providing valuation services that are outside of appraisal practice.

Refer to Advisory Opinion 21 (AO-21), *USPAP Compliance*, for further guidance.

318. PURPOSE OF AN APPRAISAL CONSULTING ASSIGNMENT

Question: Can the purpose of an appraisal consulting assignment be to develop an opinion regarding the quality of another appraiser's work?

Response: No. STANDARD 4 states, in part:

An opinion of value or an opinion as to the quality of another appraiser's work cannot be the purpose of an appraisal consulting assignment. Developing an assignment for those purposes is an appraisal or an appraisal review assignment, respectively. Misrepresenting the purpose of an assignment performed under this Standard is a violation of the ETHICS RULE. (Bold added for emphasis)

319. FEASIBILITY STUDIES AND APPRAISAL PRACTICE

Question: A client recently requested that I perform a feasibility study on a potential retail development. No value conclusions are included in the scope of the work assignment agreed upon with the client, but they have requested that I provide many of the components of what could lead to a value conclusion, such as potential income streams, capitalization rates, cost estimates, and similar information. I have completed numerous appraisal assignments for this client and I am certain that I was chosen, in large part, because I am an appraiser. Does this assignment fall within appraisal practice? And, must I comply with USPAP in completing the assignment?

Response: Yes. This assignment would fall under appraisal practice. Appraisal practice is defined as:

*valuation services performed by an individual acting as an appraiser, including **but not limited** to appraisal, appraisal review, or appraisal consulting.* (Bold added for emphasis)

Comment: Appraisal practice is provided only by appraisers, while valuation services are provided by a variety of professionals and others. The terms appraisal, appraisal review, and appraisal consulting are intentionally generic and are not mutually exclusive. For example, an opinion of value may be required as part of an appraisal review and is required as a component of the analysis in an appraisal consulting assignment. The use of other nomenclature for an appraisal, appraisal review, or appraisal consulting assignment (e.g., analysis, counseling, evaluation, study, submission, or valuation) does not exempt an appraiser from adherence to the Uniform Standards of Professional Appraisal Practice.

The feasibility analysis, described in this question clearly falls within the scope of appraisal practice; however, since it is not an appraisal, appraisal review, or real property appraisal consulting assignment as defined in USPAP, STANDARDS 1-10 do not apply. In addition, the fact that no opinions of value are part of the analysis leading to the assignment results means the example is not an appraisal consulting analysis.

Therefore, the applicable sections of USPAP would be the DEFINITIONS, the PREAMBLE, the ETHICS RULE, the COMPETENCY RULE, and the JURISDICTIONAL EXCEPTION RULE, as applicable to the assignment.

Refer to Advisory Opinion 21 (AO-21), *USPAP Compliance*, for further guidance.

320. APPRAISAL VERSUS APPRAISAL CONSULTING ASSIGNMENT

Question: What is the difference between an appraisal assignment and an appraisal consulting assignment?

Response: Appraisal assignments are those where the purpose is to provide an opinion of value. Appraisal consulting assignments are those where the purpose is to provide an analysis, recommendation or opinion to solve a problem where an opinion of value is a component of the analysis. USPAP defines appraisal consulting as:

the act or process of developing an analysis, recommendation, or opinion to solve a problem, where an opinion of value is a component of the analysis leading to the assignment results.

Comment: An appraisal consulting assignment involves an opinion of value but does not have an appraisal or an appraisal review as its primary purpose.

Also, the Comment to STANDARD 4 (Real Property Appraisal Consulting, Development) states, in part:

...the purpose of an assignment under this Standard is always to develop, without advocacy, an analysis, recommendation, or opinion where at least one opinion of value is a component of the analysis leading to the assignment results. ...An opinion of value or an opinion as to the quality of another appraiser's work cannot be the purpose of an appraisal consulting assignment. Developing an assignment for those purposes is an appraisal or an appraisal review assignment, respectively.

An example of a real property appraisal consulting assignment is a feasibility study where the client is seeking advice regarding most profitable development strategies. In the feasibility study, opinions of value would be used to test different scenarios. Those opinions of value may be provided by the appraiser doing the consulting assignment (feasibility study) or by another appraiser.

321. WHICH USPAP STANDARDS APPLY TO PERSONAL PROPERTY APPRAISAL CONSULTING?

Question: I'm aware that STANDARDS 4 and 5 in USPAP apply to real property appraisal consulting, but which Standards apply to personal property appraisal consulting?

Response: There are no Standards (STANDARDS 1-10) or Standards Rules that apply to personal property appraisal consulting. However, the portions of USPAP generally applicable to appraisal practice would apply. These portions include the DEFINITIONS, the PREAMBLE, the ETHICS RULE, the COMPETENCY RULE, and the JURISDICTIONAL EXCEPTION RULE. In addition, the RECORD KEEPING RULE states that a workfile is required for each appraisal consulting assignment and the SCOPE OF WORK RULE begins, "For each appraisal, appraisal review, and appraisal consulting assignment, an appraiser must..." Therefore, both the RECORD KEEPING RULE and the SCOPE OF WORK RULE apply to all appraisal consulting, not only to real property appraisal consulting.

INDEX

2012-2013 EDITION

INDEX

INDEX

APPRAISAL STANDARDS BOARD



THE APPRAISAL FOUNDATION

*Authorized by Congress as the Source of Appraisal
Standards and Appraiser Qualifications*

INDEX

The Index to words or phrases is not part of the *Uniform Standards of Professional Appraisal Practice* (USPAP), but is a form of “other communications” issued by the Appraisal Standards Board. Also included in this section is a reference guide illustrating the relationship between the processes used in appraisal, appraisal review, and appraisal consulting and USPAP.

The references are to the words or phrases as they appear in kind or as a topic in the 2012-2013 Edition of USPAP, the *USPAP Advisory Opinions* and the *USPAP Frequently Asked Questions*. The following abbreviations are used in the Index:

Uniform Standards of Professional Appraisal Practice

DEFINITIONS	DEF
PREAMBLE	PRE
ETHICS RULE	ER
COMPETENCY RULE	CR
SCOPE OF WORK RULE.....	SWR
JURISDICTIONAL EXCEPTION RULE	JER
Standards	STD
Standards Rules	SR
Statements on Appraisal Standards	SMT

<u>USPAP Advisory Opinions</u>	AO
---	----

<u>USPAP Frequently Asked Questions</u>	FAQ
--	-----

A

Acting as an Appraiser	
Appraisal Practice, DEF	U-1
Ad Valorem Tax	
Advisory Opinion 32	A-108
Documentation, SR 6-8(b).....	U-52
Models, SR 6-8(k)	U-54
STANDARD 6 Applies, STD 6.....	U-46
Addressees	
Clients, and Intended Users, FAQ 123	F-58
Administrative Review	
Example	A-67
Terminology, AO-20	A-55
Adverse Condition	
Requirement to Disclose, FAQ 38	F-24
Requirement to Disclose, FAQ 51	F-24
Advertising	
Expectations, AO-21.....	A-62
Misleading, ER	U-8
Advisory Opinions	
Status of, FAQ 1	F-1
Advocacy	
Assignment May be Performed Outside USPAP, FAQ 317.....	F-156

In Services, AO-21	A-63
Indicated by Contingent Fees, FAQ 317 F-156	
Agent	
Appraisal Management Company, FAQ 116F-55	
Agreement of Sale	A-1
Analyze, SR 1-5(a)	U-20
Analyze, SR 7-5(a)	U-61
Lender Refuses to Provide to Appraiser, FAQ 191	F-90
Not Provided to Appraiser, FAQ 190	F-89
Not Provided, FAQ 216	F-104
Proper Analysis, FAQ 227	F-109
Sales History, AO-1	A-1
Allocations of Value	
Obligations, FAQ 188.....	F-87
AMC, FAQ 50	F-23
Analyze	
Without Knowing Sale Price, FAQ 223 F-108	
ANSI Measurement Standards	
FAQ 162	F-76
Anticipated Improvements	
SR 1-4(f)	U-20
SR 6-6(e).....	U-52
Appraisal.....	U-1

Appraisal Report.....	<i>See</i> Report
Benchmark, DEF	U-1
Business Appraisal, STD 9	U-71
Credible	<i>See</i> Credible
Defined, DEF	U-1
Effective Date of.....	<i>See</i> Effective Date
in Appraisal Practice, DEF	U-1
Inspection.....	<i>See</i> Inspection
Intangible Asset, STD 9.....	U-71
Mass Appraisal, STD 6.....	U-46
Numerically Expressed, DEF	U-1
Range of Value	
FAQ 165.....	F-77
Range of Value DEF.....	U-1
Real Property Appraisal, STD 1	U-16
Reviewer's Own Opinion of Value	
AO-20	A-54
Update.....	<i>See</i> Appraisal Update
vs. Appraisal Consulting, FAQ 320.....	F-158
Appraisal Consulting	
and Developing Own Opinion of Value, FAQ 316	F-156
and Income and Expense Analyses, FAQ 179 F-83	
Defined, DEF	U-1
Development, STD 4	U-39
in Appraisal Practice, DEF	U-1
Personal Property, FAQ 321.....	F-159
Purpose Cannot be Opinion of Quality of Another Appraiser's Work, FAQ 318.....	F-157
Reporting, STD 5.....	U-42
vs. Appraisal, FAQ 320	F-158
Appraisal Consulting Report	
Required Content, SR 5-2.....	U-42
APPRAISAL FEE AS PERCENTAGE OF VALUE	<i>See</i> Compensation
Appraisal Practice	
and Feasibility Analysis FAQ 319.....	F-157
Defined, DEF	U-1
Relationship to Standards, AO-21	A-63
Relationship to Valuation Services, AO-21A-62	
Appraisal Procedures <i>See</i> Recognized Methods and Techniques	
Appraisal Process <i>See also</i> , Methods and Techniques	
Diagram, AO-22	A-71
Appraisal Report	
AO-16	A-35
in Business Appraisal	
Required Content, SR 10-2(a).....	U-75
Appraisal Review .. <i>See</i> Appraisal Review Report	
and Post-Valuation Date Data, FAQ 268F-145	
and Post-Valuation Date Data, FAQ 295F-145	
Defined, DEF	U-1
Development and Reporting, STD 3.....	U-31
Development, SR 3-1.....	U-31
Geographic Competency, FAQ 294.....	F-144
Illustration, AO-21.....	A-67
in Appraisal Consulting, SR 5-2(g)	U-43
in Appraisal Practice, DEF	U-1
Reporting Results	
AO-18	A-43
Reporting Results, SR 3-2	U-31
Review Appraiser Cannot Change Value in Original Report, FAQ 307.....	F-150
Reviewer Bias, FAQ 311	F-152
Reviewer Concurs with Value, FAQ 297F-146	
Reviewer Disagrees with Value, FAQ 296	F-145
Reviewer Permitted to File Complaint with State Board, FAQ 298	F-147
Reviewer's Own Opinion of Value	
Advisory Opinion 20.....	A-54
SR 3-1(c).....	U-34
SR 3-2(d).....	U-36
Reviewer's Own Opinion of Value	
Different Effective Date	
FAQ 314	F-154
Scope of Work	
FAQ 308	F-151
Reviewing a Review Report, FAQ 304	F-149
Reviewing Multiple Appraisals in One Assignment	
FAQ 300.....	F-148
FAQ 302.....	F-149
Reviewing Portion of Report Permissible, FAQ 306	F-150
Scope of Work Requirements, FAQ 305F-150	
STD 3 Applies to State Boards FAQ 303F-149	
Use of an AVM, AO-18.....	A-46
Using Additional Information to Discredit Appraiser, FAQ 309	F-151
vs Cosigning, STD 3.....	U-37
vs Reading an Appraisal, FAQ 299	F-147
When STD 3 Applies, FAQ 293	F-144
Appraisal Review Report	
Report Content, AO-20.....	A-57
Appraisal Update	
Advisory Opinion 3	A-7
with No Change in Value, FAQ 195.....	F-91
Appraiser	
Acting As, AO-21	A-62
and Continuing Education, FAQ 99.....	F-46
Defined, DEF	U-1
Ethical Obligations, PRE	U-6
Expectations, Obligations, AO-21	A-62
Public Trust, PRE	U-6
Appraiser Credentials	
and Listing in Appraisal Reports FAQ 260F-128	

Must Reviewer be Credentialed in the State	SR 1-4(e).....	U-20
Jurisdiction of the Subject Property, FAQ 301	SR 6-6(d)	U-52
..... F-148	Assignment	
Appraiser Qualifications	Defined, DEF	U-2
Not Required to be in Report by USPAP,	New, and Confidential Information, FAQ 197F-92	
FAQ 290	New, And Sale Price Change, FAQ 135..	F-63
Appraiser's Peers	New, and Scope of Work Changes After Report	
Test of Scope of Work Acceptability	Submitted, FAQ 155	F-73
AO-29	New, Explained, FAQ 198.....	F-92
A-96	New, not Necessary to "Start from Scratch,"	
Appraiser-Client Relationship	FAQ 173.....	F-92
Appraiser, DEF	Assignment Conditions	
Confidential Nature, ER	Jurisdictional Exception is One, DEF,	
Illustrations, AO-26	Jurisdictional Exception	U-3
Not Created by Fee Payment, FAQ 114 ..	State May Require Sales History Longer Than	
Party Receiving Report, SMT-9	Three Years, FAQ 220	F-106
U-96	Unacceptable	
Appraiser's Peers	AO-19	A-49
Identifying, FAQ 156.....	SWR.....	U-14
Identifying, Illustration, AO-29	Unacceptable, Fact Nondisclosure, FAQ 34F-16	
Knowledge of Practices, FAQ 156	Assignment Results	
Test of Scope of Work Acceptability	Assignment Specific, AO-27	A-89
SWR.....	Confidential Nature	
U-14	FAQ 53.....	F-24
Appraising Physical Segments of a Property	Confidential Nature,AO-27	A-88
Extraordinary Assumption not Necessary	Confidential Nature, ER.....	U-9
FAQ 176.....	Credible. See Credible Assignment Results, See	
F-81	Credible Assignment Results	
FAQ 177.....	Defined, DEF	U-2
F-82	Not Misleading, ER	U-7
Five Acre Portion of Larger Parcel, FAQ 178 ...	Assistance	
..... F-82	Advisory Opinion 31	A-104
Hypothetical Condition not Necessary	credit for, FAQ 244.....	F-117
FAQ 176.....	Defined, FAQ 243	F-116
F-81	Disclosure	
FAQ 177.....	SR 2-2(a)(vii)	U-24
F-82	SR 2-2(b)(vii)	U-26
Permitted by USPAP, FAQ 176.....	SR 2-2(c)(vii)	U-28
F-81	SR 3-2(c).....	U-36
Appraising Physical Segments of Property	SR 5-2(f)	U-43
Appraising Only the Land Under Improved	SR 6-8(j).....	U-54
Property, FAQ 177	SR 8-2(a)(vii)	U-64
F-82	SR 8-2(b)(vii)	U-66
SR 1-2(e) <u>Comment</u>	SR 8-2(c)(vii)	U-68
U-18	SR 10-2(a)(viii)	U-76
SR 6-2(g)(v) <u>Comment</u>	SR 10-2(b)(viii).....	U-78
U-49	in Certification	
Appraising the Same Property for a New Client	SR 2-3	U-29
Advisory Opinion 27	SR 3-3	U-37
A-88	SR 5-3	U-44
Release Not Required, FAQ 128	SR 6-9	U-55
F-60	SR 8-3	U-69
Release Permissible, FAQ 129	SR 10-3	U-79
F-61	Where to Describe, FAQ 246	F-119
Approaches Excluded		
SR 2-2(a)(viii).....		
U-24		
SR 2-2(b)(viii)		
U-26		
SR 2-2(c)(viii).....		
U-28		
SR 8-2(a)(viii).....		
U-64		
SR 8-2(b)(viii)		
U-66		
SR 8-2(c)(viii).....		
U-68		
SR 10-2(a)(ix).....		
U-77		
SR 10-2(b)(ix).....		
U-78		
As-Is Condition		
and EA, FAQ 211		
F-101		
and HC, FAQ 211		
F-101		
FAQ 211		
F-101		
Assemblage		

Assumption(s)
 Defined, DEF U-2
 Disclose All
 SR 2-1(c) U-22
 SR 5-1(c) U-42
 SR 6-8(c) U-52
 SR 8-1(c) U-62
 SR 10-1(c) U-75
 Assumptions, Extraordinary *See* Extraordinary Assumptions
 Automated Valuation Model
 Advisory Opinion 18 A-42
 and an Appraiser's USPAP Obligations,
 FAQ 182 F-84
 Is an AVM an Appraisal, FAQ 181 F-83
 Avoiding Error *See* Error Avoidance

B

Bias
 Defined, DEF U-2
 Prior Appraisal does not Create, FAQ 311F-152
 Blockage Discount
 Applicability, FAQ 185 F-85
 Brokerage and Appraisal
 Illustration, AO-21 A-67
 Business Appraisal
 Development, STD 9 U-71
 Relying on Real Property Appraisal, FAQ 247 ..
 F-119
 Relying on Real Property Appraisal, FAQ 251 ..
 F-122
 Reporting, STD 10 U-75
 Underlying Asset Value, Necessity of Real
 Property Appraisal, FAQ 187 F-86
 Business Enterprise
 Defined, DEF U-2
 Business Equity
 Defined, DEF U-2
 Buying Appraisal Practice
 and Confidentiality, FAQ 72 F-34
 Buy-Sell Agreement
 Identify, SR 9-2(e)(iii) U-72

C

Carelessness (Avoiding)
 SR 1-1(c) U-16
 SR 4-1(c) U-39
 SR 6-1(c) U-47
 SR 7-1(c) U-57
 SR 9-1(c) U-71
 Cash Equivalency
 in Market Value, DEF U-4

Catastrophic Events
 Appraising After, FAQ 202 F-94
 Certification *See Also* Signature, *See Also* Relying on
 the Work of Others
 1004MC, FAQ 249 F-120
 and Appraiser Coercion, FAQ 13 F-6
 Appraisal Consulting Report, SR 5-3 U-44
 Appraisal Review Report
 Reviewer's Own Opinion of Value, Two
 Certifications Not Required, FAQ 315F-154
 SR 3-3 U-36
 Business Appraisal Report, SR 10-3 U-79
 Business Entity Cannot Sign, FAQ 242 F-116
 Elements Explained, FAQ 231 F-112
 Exactly as Presented in USPAP, FAQ 232F-113
 Mass Appraisal Report, SR 6-9 U-55
 More than One Appraiser, AO-31 A-104
 Multi-Discipline
 AO-31 A-104
 FAQ 250 F-121
 Personal Property, FAQ 252 F-123
 Real Property, FAQ 250 F-121
 Personal Property Appraisal Report, SR 8-3U-69
 Real Property Appraisal Report, SR 2-3 U-29
 Reason for, FAQ 231 F-112
 Signed Certification in Workfile, FAQ 85F-40
 Signed Certification Required
 SR 2-3 U-29
 SR 3-3 U-36
 SR 5-3 U-44
 SR 6-9 U-55
 SR 8-3 U-69
 SR 10-3 U-79
 Charity Event Appraisals *See* Compliance
 FAQ 10 F-5
 Clear and Accurate *See* Report, Clear and Accurate
 Client
 Anonymous
 FAQ 274 F-133
 SMT-9 U-95
 SR 2-2(a)(i) U-23
 SR 2-2(b)(i) U-25
 SR 2-2(c)(i) U-27
 SR 5-2(a) U-42
 SR 8-2(a)(i) U-63
 SR 8-2(b)(i) U-65
 SR 8-2(c)(i) U-67
 SR 10-2(a)(i) U-76
 SR 10-2(b)(i) U-77
 Appraisal Management Company, FAQ 117F-55
 Disclosure of Prior Relationship, FAQ 56F-26
 Expectations, AO-27 A-90
 Identification Not Possible, FAQ 118 F-55
 Identifying

- AO-22 A-71
FAQ 274..... F-133
SR 1-2(a)..... U-17
SR 4-2(a)..... U-40
SR 6-2(a)..... U-47
SR 9-2(a)..... U-71
in a Federally Related Transaction
AO-25 A-84
FAQ 127..... F-60
Payment by Party Other Than Client, FAQ 114 ..
..... F-54
State the Identity
SR 2-2(a)(i) U-23
SR 2-2(b)(i) U-25
SR 2-2(c)(i) U-27
SR 5-2(a)..... U-42
SR 6-8 (d)..... U-53
SR 8-2(a)(i) U-63
SR 8-2(b)(i) U-65
SR 8-2(c)(i) U-67
SR 10-2(a)(i) U-76
SR 10-2(b)(i) U-77
CLIENT
Defined, DEF U-2
Client as Sole Intended User, FAQ 123..... F-58
Client Identification of
FAQ 113 F-54
Client vs. Intended User, FAQ 115 F-54
Client-Appraiser Relationship *See* Appraiser-Client
Relationship
Coercion, FAQ 13..... F-6
Comments
Integral Part of USPAP, PRE U-6
Same Weight, PRE U-6
Comp Check
Can Appraisers Perform, FAQ 201 F-93
Disclosure of No Fee Charged, FAQ 48.. F-22
Discussed, FAQ 200 F-93
May be an Appraisal, FAQ 200 F-93
Service Requested, AO-19..... A-52
vs Providing Data, FAQ 200..... F-93
Comp Check Assignments
No Fee Charged, FAQ 47 F-21
Compensation
Based on Appraised Value by Statute, FAQ 105
..... F-49
Contingent
on Appraised Value Range, FAQ 41... F-19
on Pending Sale Price, FAQ 42..... F-20
on Percentage of Value, FAQ 40..... F-19
on Reduced Fee if No Closing, FAQ 39F-18
Contingent ER U-8
Discounted Fees, FAQ 43 F-20
Payment at Loan Closing, FAQ 49 F-22
Reciprocal Business Arrangements, FAQ 45F-21
USPAP Applicability if no Fee Charged, FAQ 46
..... F-21
Competency
and Statement in Report, FAQ 100 F-47
COMPETENCY RULE, Compliance, FAQ 97..
..... F-45
COMPETENCY RULE, Compliance, FAQ 98..
..... F-45
Geographic in Appraisal Reviews, FAQ 294.. F-
144
in Retrospective Value Opinions, FAQ 139F-65
COMPETENCY RULE..... U-11
Complaint Submission
STD 3 Compliance Not Required, FAQ 312F-152
Complete Review
Terminology, AO-20 A-55
Compliance
and Ad Valorem Tax Consulting, FAQ 317F-156
and Fannie Mae Form 1004, FAQ 285 .. F-138
and Federally Related Transactions, AO 30A-100
Form Reports
FAQ 282..... F-137
FAQ 284..... F-138
Required by Law, Regulation, Agreement
Appraiser Obligated, ER U-7
USPAP Does Not Establish, PRE U-6
State Boards and STD 3 Appraisal Reviews,
FAQ 303..... F-149
USPAP
and PP Appraisers, FAQ 10 F-5
with other Standards, FAQ 11..... F-5
USPAP Compliance
and Catastrophic Events, FAQ 202 F-94
and Feasibility Analysis, FAQ 319 ... F-157
and JER, FAQ 103 F-48
AO-21 A-60
Instructors, FAQ 9..... F-4
Compliance with USPAP
by Choice, FAQ 5 F-2
PP & IP Appraisers, FAQ 6..... F-3
Concessions
Sales or Financing, FAQ 160..... F-75
Concurring with Value
Appraisal Review, SR 3-1(a) U-34
Illustrations, AO-20 A-59
Condition and Marketability Reports *See* Sales
History, Analysis
and USPAP Compliance, FAQ 32..... F-14
Conduct section of ETHICS RULE..... U-7
Confidential Information
Act in Good Faith in Use of, ER..... U-8
and Peer Review Committee, FAQ 67..... F-31
and Submissions to State Appraiser Boards,

FAQ 64 F-30
 Application of JER to State's Request, FAQ 91..
 F-53
 Defined, DEF U-2
 Disclosure of Former Client, FAQ 56..... F-26
 Federal Privacy Laws, FAQ 68..... F-32
 Must Not Disclose ER U-9
 Past Clients, FAQ 57 F-26
 Peer Review Committee ER U-9
 Redaction, ER..... U-9
 Report Received by Others, FAQ 54 F-25
 Selling an Appraisal Practice, FAQ 71 F-33
 When Buying Appraisal Practice, FAQ 72F-34
 Confidential Results
 Must Not Disclose, FAQ 53 F-24
 Report Received by Others, FAQ 54 F-25
 Confidentiality
 and Appraisals Under Review, FAQ 63 .. F-29
 and Copyrighting Appraisal Report, FAQ 70F-33
 and Disclosure of Prior Assignment, FAQ 55F-26
 and Federal Privacy Laws, FAQ 68..... F-32
 and Intended Users, FAQ 62..... F-29
 And State Attorney General Re, FAQ 65 F-30
 and State Regulatory Agencies, FAQ 65 . F-30
 and Sworn Peace Officer Requests, FAQ 66F-31
 and When it Ends, FAQ 69 F-32
 Redacted Sample Repor, FAQ 59 F-27
 Sample Appraisal Reports, FAQ 58..... F-27
 Confidentiality and E-Mail Delivery, FAQ 61F-29
 Confidentiality Disclaimers
 and Sample Appraisal Reports, FAQ 60.. F-28
 Confidentiality section of ETHICS RULE U-8
 Confidentiality Section of ETHICS RULE
 Filing Complaint with State Board is Not Breach,
 FAQ 298..... F-147
 Conflicts of Interest
 FAQ 16 F-8
 Contamination.*See* Environmental Contamination
 Contract *See* Agreement of Sale
 Contrary to Law
 JURISDICTIONAL EXCEPTION RULE, JER15
 F-49
 Copy
 Copies of Workfiles, FAQ 79 F-37
 Paper Copy of Report Delivered Electronically not
 Required, FAQ 283 F-138
 Photocopy of Report in Workfile, FAQ 76F-36
 Copyrighting an Appraisal Report
 and Confidentiality, FAQ 70 F-33
 Cost
 Defined, DEF U-3
 Remediation Cost, AO-9..... A-18
 Cost Approach
 and USPAP Limitations on Adjustments,

FAQ 193 F-90
 Not Necessary When Appraising Vacant Land,
 FAQ 173 F-80
 SR 1-4(b) U-19
 SR 6-6(a)..... U-51
 Credentials
 Included, FAQ 261 F-128
 Credible
 Appraisal, Business Valuation, STD 9 ... U-71
 Appraisal, Real Property, STD 1 U-16
 Assignment Results *See* Credible, DEF
 AO-29 A-97
 SWR..... U-13
 Defined, DEF U-3
 Explained, FAQ 152 F-72
 Mass Appraisals, STD 6 U-46
 Results, STD 4 U-39

D

Data Source Referencing
 and Workfile Requirement, FAQ 94..... F-43
 Date of Appraisal.*See Also*, Effective Date, *See Also*,
 Date of the Report
 FAQ 131 F-62
 Date of the Report
 State
 SR 2-2(a)(vi) U-24
 SR 2-2(b)(vi) U-26
 SR 2-2(c)(vi) U-28
 SR 5-2(e) U-43
 SR 6-8(g)..... U-53
 SR 8-2(a)(vi) U-63
 SR 8-2(b)(vi) U-65
 SR 8-2(c)(vi) U-67
 SR 10-2(a)(vii) U-76
 SR 10-2(b)(vii) U-78
 Date of Value
 Same as Effective Date, FAQ 132 F-62
 Definition of Value.*See* Type and Definition of Value,
See Standard (type) and Definition of Value
 Describe
 In Reporting, AO-11 A-25
 Desk Review
 Terminology, AO-20 A-55
 Desktop Appraisal ..*See* Exterior Only Inspection
 Different Clients with Identical Assignment Elements
 and Scope of Work, FAQ 150 F-71
 Diminution in Value (Property Value Diminution)
 Defined, AO-9 A-18
 Disagreement with Supervisor
 as to Value Opinion, FAQ 248 F-120
 Discounted Cash Flow Analysis
 FAQ 288 F-142

SMT-2.....	U-82	SR 2-2(c)(vi)	U-28
Discrimination		SR 5-2(e).....	U-43
Fair Housing Laws, AO-16.....	A-34	SR 8-2(a)(vi)	U-63
Disposal of workfile, FAQ 75	F-36	SR 8-2(b)(vi).....	U-65
Drive-By Inspection <i>See</i> Exterior-Only Inspection		SR 8-2(c)(vi)	U-67
Due Diligence		SR 10-2(a)(vii).....	U-76
SR 1-1(c).....	U-16	SR 10-2(b)(vii).....	U-78
SR 6-1(c).....	U-47	Effective Date Change	
SR 7-1(c).....	U-57	and New Assignment, FAQ 134	F-63
SR 9-1(c).....	U-71	Effective date, FAQ 138.....	F-64
Due process of law, FAQ 52.....	F-24	Electronic Copy	
		Electronic Workfile Storage, FAQ 92	F-42
		Electronic Delivery of Reports <i>See</i> Report Delivery	
		Environmental Contamination	
		Appraisal of	
		Real Property Impacted by, AO-9	A-16
		Defined, AO-9	A-18
		Environmental Risk	
		Defined, AO-9	A-18
		Environmental Stigma	
		Defined, AO-9	A-18
		Error Avoidance	
		FAQ 153	F-72
		FAQ 154	F-73
		SR 1-1(b)	U-16
		SR 4-1(b)	U-39
		SR 6-1(b)	U-47
		SR 7-1(b)	U-57
		SR 9-1(b)	U-71
		Errors and Omissions Insurance	
		and CR, FAQ 101	F-47
		USPAP Does Not Address, FAQ 101	F-47
		Errors of Commission	
		FAQ 153	F-72
		Errors of Omission	
		SR 1-1(b)	U-16
		SR 4-1(b)	U-39
		SR 6-1(b)	U-47
		SR 7-1(b)	U-57
		SR 9-1(b)	U-71
		Errors, Series of, FAQ 154	F-73
		ETHICS RULE.....	U-7
		Conduct section	U-7
		Confidentiality section.....	U-8
		Management section	U-8
		Evaluations of Real Property Collateral	
		AO-13	A-29
		Expectations	
		of an Appraiser, AO-21	A-62
		Expired Listings	
		Obligation to Analyze, FAQ 151	F-72
		Exposure Time	
		Prior to the Effective Date, SMT-6.....	U-90
		Reasonable Exposure Time, SMT-6.....	U-90
E			
Effective Date	<i>See Also</i> , Retrospective Value		
Opinions, <i>See Also</i> , Prospective Value Opinions			
and Changing It Later, FAQ 134	F-63		
and Citation With Each Statement of Value			
Opinion, FAQ 133.....	F-62		
and Exposure Time, SMT-6.....	U-90		
and Marketing Time, AO-7	A-13		
Current and Prospective in Same Report,			
FAQ 142	F-66		
Current Appraisal			
SMT-3	U-85		
SMT-4	U-87		
with Proposed Improvements, FAQ 137F-64			
Current Value, With Proposed Improvements,			
FAQ 136.....	F-64		
Identify			
SR 1-2(d).....	U-17		
SR 4-2(d).....	U-40		
SR 6-2(d).....	U-47		
SR 7-2(d).....	U-57		
SR 9-2(d).....	U-72		
Prospective Value Opinions			
SMT-4	U-87		
with Proposed Improvements, FAQ 137F-64			
Retrospective and Prospective in Same Report,			
FAQ 140.....	F-65		
Retrospective Appraisal			
SMT-4	F-87		
Retrospective Value Opinions			
and Appraiser Competency, FAQ 139	F-65		
SMT-3	U-85		
Same as Date of Value, FAQ 132.....	F-62		
Same or Different			
in Appraisal Review, SR 3-1(c)	U-34		
Set Forth			
SR 6-8(g).....	U-53		
Specificity in Report, FAQ 130	F-62		
State			
SR 2-2(a)(vi)	U-24		
SR 2-2(b)(vi).....	U-26		

vs Marketing Time, AO-7 A-13

EXPOSURE TIME

Defined, DEF U-3

Exposure time, FAQ 163 F-76

Exterior-Only Inspection

and Unacceptable Assignment Conditions,

FAQ 169 F-79

Extent of Inspection, SWR U-13

FAQ 168 F-78

Illustration, AO-2 A-5

Permitted by USPAP, FAQ 169 F-78

Extraordinary Assumption

Labeling, FAQ 209 F-100

Extraordinary Assumptions

Conditions of Use

SR 1-2(f) U-18

SR 4-2(f) U-40

SR 6-2(i) U-49

SR 7-2(f) U-58

SR 9-2(f) U-72

Defined, DEF U-3

Defined, FAQ 213 F-102

Disclose All

SR 2-1(c) U-2

SR 5-1(c) U-42

SR 6-8(c) U-52

SR 7-2(f) U-58

SR 8-1(c) U-62

SR 10-1(c) U-75

Examples, FAQ 204 F-97

Identify

SR 1-2(f) U-18

SR 4-2(f) U-40

SR 6-2(i) U-49

SR 7-2(f) U-58

SR 9-2(f) U-72

Proposed Improvements AO-17 A-37

Proposed Improvements, FAQ 137 F-64

Reporting Requirements, FAQ 208 F-99

State All

SR 2-2(a)(x) U-25

SR 2-2(b)(x) U-27

SR 2-2(c)(x) U-29

SR 3-2(d) U-36

SR 5-2(i) U-44

SR 6-8(c) U-53

SR 8-2(a)(x) U-65

SR 10-2(a)(x) U-77

SR 10-2(b)(x) U-78

vs Hypothetical Conditions, FAQ 204 F-96

F

Fair Housing Laws

AO-16 A-34

Fannie Mae

and Intended Users, \ FAQ 285 F-138

Do Forms Comply with USPAP, FAQ 284F-138

Form 1004 and Citing Source of Value Definition,

FAQ 203 F-95

Form 1004 and Cost Approach, FAQ 174F-81

Form 1004, Item, #23, FAQ 285 F-138

Form 1004D, FAQ 266 F-130

Feasibility Analysis

Defined, DEF U-3

is Part of Appraisal Practice, FAQ 319.. F-157

Federal Highway Administration, FAQ 110. F-52

Federal Highway Administration, FAQ 111. F-52

Federal Privacy Laws *See* Confidential Information

Federally Regulated Institution

Appraisals for, AO 30 A-99

Federally Related Transaction

and Value in Use, FAQ 167 F-78

Appraiser Retained by Lender, FAQ 127 F-60

As If Completed Not Required, FAQ 210F-100

Current and Prospective Effective Dates, FAQ 142

..... F-66

Fees *See* Compensation

Field Review *See* Appraisal Review

Terminology, AO-20 A-55

Financial Reporting

and USPAP Applicability, FAQ 7 F-3

Flipping *See* Property Flipping

Free Comp Check

May Appraisers Perform, FAQ 47 F-21

H

Highest and Best Use

Analyze Effect

in Real Property, SR 6-3(a) U-49

Describe Support

SR 2-2(a)(ix) U-25

Develop an Opinion of, SR 1-3(b) U-19

Discuss How Determined, SR 6-8(n) U-54

State

SR 2-2(c)(ix) U-29

Summarize Support

SR 2-2(b)(ix) U-27

Hypothetical Condition

Labeling, FAQ 209 F-100

Hypothetical Conditions

Appropriate Use, FAQ 206 F-98

Conditions for Use

SR 4-2(g) U-41

SR 6-2(i) U-49

SR 7-2(g) U-58

SR 9-2(g) U-72

SR 1-2(g).....	U-18	SR 2-3	U-29
Defined, DEF.....	U-3	SR 3-3	U-37
Disclose All		SR 5-3	U-44
SR 2-1(c).....	U-22	SR 6-9	U-55
SR 5-1(c).....	U-42	SR 8-3	U-69
SR 6-8(c).....	U-52	Physical Inspection vs Viewing Photographs, FAQ 170.....	F-79
SR 8-1(c).....	U-62	Instant Messages Considered to be Appraisal Reports,FAQ 264.....	F-129
SR 10-1(c).....	U-75	Instructors	<i>See Compliance</i>
Examples, FAQ 205.....	F-97	Intangible Asset Appraisal	
Identify		Development, STD 9	U-71
SR 1-2(g).....	U-18	Reporting, STD 10.....	U-75
SR 4-2(g).....	U-41	Intangible Assets	
SR 6-2(i).....	U-49	Defined, DEF	U-3
SR 7-2(g).....	U-58	Intangible Property	
SR 9-2(g).....	U-72	Defined, DEF	U-3
Proposed Improvements		Intended Use	
FAQ 137.....	F-64	and Problem Identification	
SR 1-2(e), <u>Comment</u>	U-18	SMT-9.....	U-94
SR 6-2(e), <u>Comment</u>	U-48	SWR.....	U-13
SR 7-2(e).....	U-57	Credibility in Context of, SWR	U-14
Proposed Improvements, AO-17	A-37	Defined, DEF	U-3
Reporting Requirements, FAQ 208	F-99	Establishes Obligations, SMT 9.....	U-95
State All		Identified by the Appraiser, DEF.....	U-3
SR 2-2(a)(x)	U-25	Identify	
SR 2-2(b)(x)	U-27	SR 1-2(b).....	U-17
SR 2-2(c)(x)	U-29	SR 4-2(b).....	U-40
SR 3-2(d).....	U-36	SR 6-2(b).....	U-47
SR 5-2(i).....	U-44	SR 7-2(b).....	U-56
SR 6-8(c).....	U-53	SR 9-2(b).....	U-71
SR 10-2(a)(x)	U-77	More Than One in an Assignment, FAQ 166F-77	
SR 10-2(b)(x)	U-78	Reporting Requirements	U-42
vs Extraordinary Assumptions, FAQ 204 F-96		Adequacy of Disclosure, FAQ 276 ...	F-134
		SR 2-2	U-22
		State	
		SR 2-2(a)(ii)	U-23
		SR 2-2(b)(ii).....	U-25
		SR 2-2(c)(ii)	U-27
		SR 5-2(c).....	U-43
		SR 6-8(e).....	U-53
		SR 8-2(a)(ii)	U-63
		SR 8-2(b)(ii).....	U-65
		SR 8-2(c)(ii)	U-67
		SR 10-2(a)(ii)	U-76
		SR 10-2(b)(ii).....	U-77
		STATEMENT, SMT-9	U-94
		Intended Use Reporting Requirements	U-75
		SR 8-2	U-62
		Intended User	
		Same as Client, and No Other Intended Users, FAQ 123.....	F-58
		Intended User Unidentified, FAQ 124.....	F-59
		Intended User(s)See FAQ 122 for specific examples	

I

Identification of Client

FAQ 113

Identification of the Problem.....*See Problem*

Identification

Impaired Value

Defined, AO-9

Income and Expense Analyses

as an Appraisal Consulting Assignment, FAQ 179

.....

Income Approach

SR 1-4(c).....

SR 6-6(a).....

SR 7-4(c).....

Inspection *See Also, Exterior-Only Inspection*

Extent of, SWR.....

Exterior-Only, AO-2.....

of Subject, AO-2.....

Personal Inspection

Certification

and Borrowers, FAQ 125 F-59
 and Problem Identification
 SMT-9 U-94
 SWR U-13
 Appraiser Responsibilities Regarding, AO-21 A-63
 Client, DEF U-3
 Defined, DEF U-3
 Identified by the Appraiser, DEF U-3
 Identified by the Appraiser, FAQ 122 F-57
 Identify
 SR 1-2(a) U-17
 SR 4-2(a) U-40
 SR 6-2(a) U-47
 SR 7-2(a) U-56
 SR 9-2(a) U-71
 Identify by Name or Type
 DEF U-3
 FAQ 273 F-133
 Identify by Type, FAQ 126 F-60
 Must be Identified, FAQ 273 F-133
 Obligations to
 SMT-9 U-95
 Reliance Letter, FAQ 119 F-56
 Reporting Requirements U-62
 Adequacy of Disclosure, FAQ 275 ... F-134
 SR 2-2 U-22
 State the Identity
 SR 2-2(a)(i) U-23
 SR 2-2(b)(i) U-25
 SR 5-2(a) U-42
 SR 6-8(d) U-53
 SR 8-2(a)(i) U-63
 SR 8-2(b)(i) U-65
 SR 10-2(a)(i) U-76
 STATEMENT, SMT-9 U-94
 Intended User(s) Reporting Requirements
 SR 10-2 U-75
 STD 5 U-42
 Intended User(s) vs. Client, FAQ 115 F-54
 Intended Users
 and Confidentiality, FAQ 62 F-29
 Multiple, FAQ 277 F-135

J

Jurisdictional Exception
 Appropriate Source, FAQ 106 F-49
 Can Attorneys Create, FAQ 106 F-49
 Defined, DEF U-3
 State Requirements Not Jurisdictional Exception, FAQ 95 F-44
 JURISDICTIONAL EXCEPTION RULE .. U-15
 and USPAP Compliance, FAQ 103 F-48

and Valuation Methods, FAQ 107 F-50
 Application to State's Request for Confidential Information, FAQ 112 F-53
 Application, FAQ 102 F-48
 in Ad Valorem Taxation, STD 6 U-46
 May Reduce USPAP Requirement(s), FAQ 104 F-49

L

Labeling
 Extraordinary Assumption, FAQ 209 ... F-100
 Hypothetical Condition, FAQ 209 F-100
 Laws
 Described, SWR U-14
 Fair Housing, AO-16 A-34
 Privacy, ER U-9
 Lease Analysis
 FAQ 8 F-4
 Leased Fee Interests
 Real Property vs Intangible, FAQ 189 F-88
 Letter of Transmittal
 Defined, FAQ 259 F-128
 Limiting Conditions
 Disclose All
 SR 2-1(c) U-22
 SR 5-1(c) U-42
 SR 6-8(c) U-52
 SR 8-1(c) U-62
 SR 10-1(c) U-75
 Liquidation Value
 Business Enterprise With Real Property Assets, FAQ 187 F-86
 Listings (of Subject Property)
 AO-1 A-1
 SR 1-5(a) U-20
 Litigation Services
 Illustration, AO-21 A-68

M

Management section of ETHICS RULE U-8
 Market Rent
 Is It An Appraisal, FAQ 158 F-74
 Market Value
 Definition for Federally Related Transactions, FAQ 30 F-102
 Definition in FIRREA, AO-22 A-73
 Described, DEF U-3
 Exposure Time, SMT-6 U-90
 Scope of Work in
 Market Value Assignments, AO-22 ... A-70
 vs Anticipated Sales Price, AO-22 A-73
 Marketing Time Opinions, AO-7 A-13

- Marketing time, FAQ 163..... F-76
- Mass Appraisal
- Defined, DEF..... U-4
 - Development and Reporting, STD 6..... U-46
 - in Ad Valorem Tax Assignments, AO-32A-108
 - Methodology does not Address Blockage
 - Discount, FAQ 185 F-85 - Methodology not Required in Appraisal of Large
 - Number of Assets, FAQ 184 F-85
- Mass Appraisal Model
- Defined, DEF..... U-4
- Mass Appraisal Report
- Required Content, SR 6-8..... U-52
- Methods and Techniques..... *See* Recognized
- Approaches, Methods and Procedures for
- Business Appraisals
- Describe
- SR 2-2(a)(viii)..... U-24
 - SR 8-2-(a)(viii)..... U-64
- Employ Recognized
- SR 1-1(a)..... U-16
 - SR 4-1(a)..... U-39
 - SR 6-1(a)..... U-46
- State
- SR 2-2(c)(viii)..... U-28
 - SR 8-2(c)(viii)..... U-68
- Summarize
- SR 2-2(b)(viii)..... U-26
 - SR 5-2(g)..... U-43
 - SR 8-2 (b)(viii)..... U-66
- USPAP Does not Dictate Methodology
- Land Valuation, FAQ 175..... F-81
 - Valuation of Large Number of Assets,
 - FAQ 184..... F-85
- USPAP Does not Indicate How to Perform
- Blockage Discounts, FAQ 186..... F-85
- Methods and Techniques, SR 7-1(a)..... U-57
- Misleading Communications
- and Checking Stable vs. Declining Values,
 - FAQ 164 F-77 - Must Avoid, PRE..... U-6
 - Using MLS Photos for Comparable Sales,
 - FAQ 171 F-79
- MLS Photos for Active Listings
- Permissibility, FAQ 172 F-80
- MLS Photos for Comparable Sales
- Could be Misleading, FAQ 171 F-79

N

- Negligence
- SR 1-1(c)..... U-16
 - SR 4-1(c)..... U-39
 - SR 6-1(c)..... U-47

- SR 7-1(c)..... U-57
 - SR 9-1(c)..... U-71
- New Assignment*See* Assignment, New
- No Fee Charged
- and Comp Checks, FAQ 47 F-21
 - and Disclosure in Comp Check Assignment,
 - FAQ 48 F-22 - and USPAP Applicability, FAQ 46 F-21
- Non-Compliance with USPAP
- Review Appraiser Citation, FAQ 310.... F-152
- Non-market Financing
- SR 1-2(c)(iv)..... U-17
 - SR 2-2(a)(v)..... U-24
 - SR 2-2(b)(v)..... U-26
 - SR 4-2(c)(ii)..... U-40
 - SR 6-2(c)(iv)..... U-47
 - SR 7-2(c)(iv)..... U-57
 - SR 8-2(a)(v)..... U-63
 - SR 8-2(b)(v)..... U-65
- Non-source Sites
- Defined, AO-9 A-19
- Normal Course of Business
- Advisory Opinion 24 A-81
 - If Available in the
 - SR 1-5 U-20
 - SR 7-5 U-61 - Illustrations, AO-24 A-82
 - Sales History, AO-1 A-1
 - and Knowledge of Sale Price, FAQ 223 F-108
- Not Misleading..... *See* Report, Not Misleading
- Numerical Benchmark
- Definition of Appraisal, DEF..... U-1

O

- Obligations
- Appraiser, Personal, ER..... U-7
 - Established by Intended Use, SMT 9..... U-95
 - Ethical, PRE..... U-6
 - Intended Use, Intended Users, SMT 9 U-95
 - Outside of Appraisal Practice, AO-21 A-63
 - Performance, PRE..... U-6
 - When Allocation of Value Opinions, FAQ 188..
 - F-87 - When Using an AVM, FAQ 182 F-84
- Offers to Sell
- Analyze, SR 7-5(a) U-61
- Options (to Purchase)
- Analyze
- SR 1-5(a)..... U-20
 - SR 7-5(a)..... U-61
 - Sales History, AO-1 A-1
- Oral Report and Workfile, FAQ 281 F-137
- Oral Report and Testimony

and Record Keeping, FAQ 89..... F-41
 and Transcript or Summary Requirement, FAQ 90
 F-42
 and Transcript Requirement, FAQ 87..... F-41
 Oral Reports..... *See Also*, Testimony
 Permissible
 FAQ 279..... F-136
 FAQ 280..... F-136
 Record Keeping Requirements, FAQ 278F-135
 Report, DEF..... U-4
 Requirements
 FAQ 280..... F-136
 SR 2-4 U-30
 SR 3-4 U-38
 SR 5-4 U-45
 SR 8-4 U-70
 SR 10-4 U-80
 Other reports
 rely on, FAQ 247 F-119

P

Peer Review Committee *See* Confidential Information
 and Confidential Information, FAQ 67.... F-31
 Peers, Appraiser's *See* Appraiser's Peers
 Personal Interest
 and Potential Conflict of Interest, FAQ 16 F-8
 Without Accommodation of, ER U-7
 Personal Property
 Defined, DEF..... U-4
 Personal Property Appraisal
 Reporting, STD 8..... U-62
 Personal Property Appraisal Requirements *See*
 Compliance
 Photocopy of Report in Workfile, FAQ 76... F-36
 Plagiarism Unethical, FAQ 14..... F-7
 Plans, Specifications
 Not Available to Appraiser, FAQ 180 F-83
 SR 1-2(e), Comment..... U-18
 SR 6-2(e)(iii), Comment..... U-48
 SR 7-2(e), Comment..... U-57
 PREAMBLE..... U-6
 Predetermined Results
 Prohibited, ER U-7
 Unacceptable Assignment Condition, FAQ 12F-6
 Price
 Defined, DEF..... U-4
 Prior Listings
 Obligation to Analyze, FAQ 226..... F-109
 Prior Sales..... *See* Sales History
 Prior Services
 Confidentiality agreement, FAQ 22..... F-10
 Confidentiality, FAQ 21 F-9
 Disclose on pre-printed forms, FAQ 28... F-12

Discloser format, FAQ 29..... F-12
 More than three years ago, FAQ 25..... F-11
 None in prior three years FAQ 18..... F-8
 Only one client, FAQ 23..... F-10
 Other than appraisal practice, FAQ 24 F-11
 Prospective interest, FAQ 27 F-11
 Provided by my company, FAQ 26 F-11
 Prior Services, FAQ 17..... F-8
 Prior Services, FAQ 19..... F-9
 Prior Services, FAQ 20..... F-9
 Problem Identification
 and Acceptable Scope of Work, AO-29 . A-96
 and COMPETENCY RULE, AO-28 A-92
 and Intended Use and Intended Users, SMT-9 U-
 94
 Assignment Elements, Necessary for, SWRU-13
 Identify the Problem
 STD 1 U-16
 STD 3 U-30
 STD 4 U-39
 STD 7 U-56
 STD 9 U-71
 Required, AO-28..... A-92
 Problem Identification section
 SWR U-13
 Property Flipping
 Explained, FAQ 31 F-13
 Safeguards in Reporting..... F-130
 USPAP Compliance to Avoid, FAQ 218F-105
 Proposed Improvements
 Appraisal of Real Property with, AO-17 A-37
 in Appraisal with Current Effective Date,
 FAQ 136 F-64
 Plans and Specs not Available, FAQ 180 F-83
 Prospective Appraisal *See* Prospective Value
 Opinions
 Prospective Value Opinions *See Also*, Effective Date
 and Proposed Improvements and Extraordinary
 Assumptions, FAQ 114..... F-64
 Proposed Improvements and Hypothetical
 Conditions, FAQ 137 F-64
 Proposed Improvements, AO-17 A-37
 SMT-4..... U-88
 Proximate Sites
 Defined, AO-9 A-19
 Public Improvements
 and Before Acquisition Value, FAQ 207. F-98
 Purchase Contract *See* Agreement of Sale
 Price Equals Value Opinion, FAQ 30..... F-12
 Purchase Offers *See* Sales History, Offers
 Purpose of USPAP
 FAQ 4 F-2
 PREAMBLE..... U-6

R	
Range of Value	
Definition of Appraisal, DEF.....	U--1
FAQ 165	F-77
Readdressing (Transferring) a Report	
Prohibited with Client Release, FAQ 121	F-57
Prohibited, AO-26.....	A-86
Prohibited, FAQ 120.....	F-56
Real Estate	
Defined, DEF	U-4
Real Property	
Defined, DEF	U-4
Real Property Appraisal	
Development, STD 1	U-16
Reporting, STD 2.....	U-22
Real Property Interest	
Lease Analysis When Appraising Fee Simple	
Interest, FAQ 212.....	F-102
Recertification of Value	
and Final Inspection, FAQ 199.....	F-92
May Comply with USPAP, FAQ 198.....	F-92
Term Explained, AO-3	A-7
Term Explained, FAQ 198.....	F-92
vs Update, FAQ 198	F-92
vs Update, FAQ 199	F-92
Recognized Approaches, Methods and Procedures	
SR 9-1(a).....	U-71
Reconciliation	
in Development SR 1-6	U-20
in Development SR 6-7(a).....	U-52
in Development SR 7-6	U-60
in Development SR 9-5	U-74
Reporting SR 2-2(a)(viii), <u>Comment</u>	U-24
Reporting SR 2-2(b)(viii), <u>Comment</u>	U-26
Reporting SR 6-8(p)	U-54
Reporting SR 8-2(a)(viii), <u>Comment</u>	U-64
Reporting SR 8-2(b)(viii) <u>Comment</u>	U-66
Reporting SR 10-2(a)(ix) <u>Comment</u>	U-77
Within Approaches to Value, FAQ 192...	F-90
Record Keeping..... <i>See</i> , Workfile	
Oral Reports and Testimony, FAQ 89	F-41
RECORD KEEPING RULE.....	U-10
Regulations	
Described, SWR	U-14
Release	
of an Appraisal Report, AO-27.....	A-89
Relevant Characteristics	
Contaminated Property, AO-29	A-19
Describe	
SR 2-2(a)(iii)	U-23
SR 8-2(a)(iii)	U-63
Identify	
SR 1-2(e).....	U-17
SR 4-2(e).....	U-40
SR 6-2(e).....	U-48
SR 7-2(e).....	U-57
of the Subject Property, AO-23	A-77
Summarize	
SR 2-2(b)(iii).....	U-25
SR 8-2(b)(iii).....	U-65
Reliance Letter, FAQ 119.....	F-56
Relying on the Work of Others	
SR 2-3, <u>Comment</u>	U-30
SR 3-3, <u>Comment</u>	U-37
SR 5-3, <u>Comment</u>	U-45
SR 6-9, <u>Comment</u>	U-56
SR 8-3, <u>Comment</u>	U-70
SR 10-3, <u>Comment</u>	U-79
Remediation Cost	
Defined, AO-9	A-18
Remediation Lifecycle	
Defined, AO-9	A-19
Rent Survey	
Illustration, AO-21.....	A-68
Report	U-62
Appraisal Consulting <i>See</i> Appraisal Consulting	
Report	
Appraisal Review <i>See</i> Appraisal Review Report	
Clear and Accurate	
SR 2-1(a).....	U-22
SR 5-1(a).....	U-42
SR 6-8(a).....	U-52
SR 8-1(a).....	U-62
SR 10-1(a).....	U-75
Defined, DEF	U-4
Draft of a Report, FAQ 291	F-142
Mass Appraisal <i>See</i> Mass Appraisal Report	
Not Misleading	
SR 2-1(a).....	U-22
SR 5-1(a).....	U-42
SR 6-8(a).....	U-52
SR 8-1(a).....	U-62
Options..... <i>See</i> Report Options	
Oral	<i>See</i> Oral Report
Ownership of, FAQ 254.....	F-125
Restricted Use Appraisal Report <i>See</i> Restricted	
Use Appraisal Report	
Self-Contained Appraisal Report..... <i>See</i> Self-	
Contained Appraisal Report	
Separate Scope of Work Section not Required,	
FAQ 272.....	F-133
Sufficient Information	
SR 2-1(b).....	U-22
SR 5-1(b).....	U-42
SR 6-8(b).....	U-52
SR 8-1(b).....	U-62

SR 10-1(b)..... U-75
 Summary Appraisal Report*See* Summary Appraisal Report
 Report Date.....*See* Date of the Report
 Report Delivery
 and Electronic Files, FAQ 255 F-126
 E-Mail Delivery, FAQ 61 F-29
 Report Options
 Business or Intangible Asset Appraisal
 SR 10-2 U-75
 Chart, AO-11 A-23
 Content of Reports
 in Real and Personal Property, AO-11 A-22
 Deciding Which to Use, AO-12..... A-27
 for Update of an Appraisal
 FAQ 263..... F-129
 FAQ 265..... F-129
 Identification of, FAQ 256..... F-126
 Must Use Required Labels, FAQ 258.... F-127
 Not Related to Number of Approaches Used, FAQ 257 F-127
 Personal Property, SR 8-2..... U-62
 Real Property, SR 2-2 U-22
 Statement of Report Option
 AO-11 A-22
 SR 2-2 U-22
 SR 8-2 U-62
 SR 10-2 U-75
 Reporting
 and Property Flipping Safeguards, FAQ 267F-130
 Applicable Standards, FAQ 286 F-141
 Appraisal Consulting, STD 5 U-42
 Appraisal Review, AO-18..... A-43
 Appraisal Review, SR 3-2, 3-3 and 3-4 .. U-31
 Business Appraisal, STD 10 U-75
 Current and Prospective Effective Dates in Same Report, FAQ 142..... F-66
 Intangible Asset Appraisal, STD 10 U-75
 Legal Description not Always Required, FAQ 268 F-131
 Mass Appraisal, STD 6 U-46
 Personal Property Appraisal, STD 8..... U-62
 Real Property Appraisal, STD 2 U-22
 Retrospective and Prospective Effective Dates in Same Report, FAQ 140..... F-65
 Street Address not Always Required, FAQ 269 F-131
 Work not Performed, FAQ 271 F-132
 Reporting requirement, FAQ 287..... F-141
 Reports
 Forms and USPAP Compliance, FAQ 282F-137
 Responsibility
 if Signing Report as Supervisor, FAQ 240F-116
 Restricted Use Appraisal Report

and Third Parties, FAQ 262 F-128
 Content of
 AO-11 A-23
 FAQ 289..... F-142
 Required Content
 SR 2-2(c)..... U-27
 SR 8-2(c)..... U-67
 SR 10-2(b)..... U-77
 Use of, AO-12..... A-27
 Retiring a Portion of USPAP
 Explained, FAQ 3 F-1
 Retrospective Appraisal.*See* Retrospective Value Opinions
 Retrospective Value Opinions
 Applicable USPAP Edition, FAQ 143 F-67
 Events After Date of Value FAQ 141 F-66
 Sales History, FAQ 229 F-110
 SMT-3..... U-85
 Using Only Data After Effective Date not Acceptable, FAQ 144..... F-67
 Review Appraiser
 and Confidentiality, FAQ 63 F-29
 Scope of Work, Uniform Act, FAQ 313 F-153
 Reviewer's Own Opinion of Value
 Concurs with Value, FAQ 297 F-146
 Disagrees with Value, FAQ 296 F-145
 Reviewer's Own Opinion of Value
 SR 3-1(c)..... U-34
 SR 3-2(d) U-36

S

Sales Comparison Approach
 SR 1-4(a)..... U-19
 SR 6-6(a)..... U-51
 Sales History
 Advisory Opinion 1 A-1
 Analysis
 Applies to One to Four Family Dwellings, FAQ 221..... F-107
 Does Not Apply to Condition and Marketability Reports, FAQ 230 F-110
 Analyze
 All Sales if More than One, FAQ 214F-103 and Errors or Omission
 FAQ 228 F-110
 and Errors or Omission, FAQ 215..... F-104
 Assignment Condition May Require More than USPAP, FAQ 220 F-106
 Expired Listing not Required, FAQ 228F-110
 SR 1-5(b)..... U-20
 SR 7-5(b)..... U-61
 and New Construction, FAQ 222..... F-107

- and Prior Sale of a Different Interest, FAQ 222 .
..... F-107
- and Prior Sale of Different Size Parcel, FAQ 222
..... F-107
- Deed in Lieu of Foreclosure, FAQ 225 . F-108
- For Comparable Sales, FAQ 224 F-108
- Foreclosure Sale AO-4..... A-10
- in Retrospective Value Opinions, FAQ 229F-110
- Normal Course of Business, AO-24 A-81
- Offers May be Relevant to Appraisal
FAQ 215..... F-104
- Offers Not Required to be Analyzed, FAQ 215..
..... F-104
- Pending Sale as Comparable Permissible,
FAQ 217 F-105
- Report
SR 2-2(a)(viii)..... U-24
SR 2-2(b)(viii)..... U-27
SR 8-2(a)(viii)..... U-64
SR 8-2(b)(viii)..... U-66
SR 8-2(c)(viii)..... U-68
- Sale of Subject as Comparable Permissible,
FAQ 219 F-106
- Sample Appraisal Reports
and Confidentiality Disclaimers, FAQ 60 F-28
and Confidentiality, FAQ 58 F-27
and Redaction for Confidentiality, FAQ 59F-27
- Scope of Work
Acceptable
Advisory Opinion 29..... A-96
SR 1-2(h)..... U-18
SR 4-2(h)..... U-41
SR 6-2(j)..... U-49
SR 7-2(h)..... U-58
SR 9-2(h)..... U-73
SWR, Acceptability..... U-14
- and Changes After Report Submitted, FAQ 155
..... F-73
- and Relevant Characteristics, AO-23..... A-77
- and Uniform Act, FAQ 183 F-84
- Defined, DEF U-4
- Describe
SR 2-2(a)(vii)..... U-24
SR 6-8(j)..... U-54
SR 8-2(a)(vii)..... U-64
- Determine
AO-28 S-93
Appraiser is Responsible, FAQ 147 F-69
Client Specifies, FAQ 148 F-69
SR 1-2(h)..... U-18
SR 4-1(h)..... U-41
SR 6-2(j)..... U-49
SR 7-2(h)..... U-58
SR 9-2(h)..... U-73
- SWR..... U-13
- Developed by Others, FAQ 183 F-84
- Developing Unnecessary Approach, FAQ 292F-
143
- Disclosure, SWR..... U-14
- Effect of Purpose, Intended Use
in Appraisal Review, AO-20..... A-55
- Explained, FAQ 145 F-69
- in an Update of an Appraisal, FAQ 194 .. F-91
- in Appraisal Review, AO-20 A-54
- in Market Value Assignments, AO-22.... A-70
- Includes Reviewer's Opinion
of Value, SR 3-1(c) U-34
- limited by client, FAQ 149 F-70
- New Assignment, not Necessarily From Scratch,
FAQ 197..... F-92
- Normal Course of Business, AO-24 A-81
- Reporting Work not Performed, FAQ 271F-132
- State
SR 2-2(c)(vii) U-28
SR 5-2(f) U-43
SR 10-2(b)(viii)..... U-78
- Summarize
SR 2-2(b)(vii)..... U-26
SR 8-2(b)(vii)..... U-66
SR 10-2(a)(viii)..... U-76
- SWR U-13
- Uniform Act, Scope of Work, FAQ 313 F-153
- Why Report, FAQ 270..... F-132
- SCOPE OF WORK RULE
Applicability, FAQ 146 F-69
- Disclosure Obligations section U-14
- Problem Identification section U-13
- Rule..... U-13
- Scope of Work Acceptability section U-14
- Self-Contained Appraisal Report
AO-11 A-22
- Required Content
FAQ 253..... F-124
SR 2-2(a)..... U-23
SR 8-2(a)..... U-63
- Use of, AO-12..... A-27
- Selling Appraisal Practice
and Confidentiality, FAQ 71 F-33
- Separations of Value..... *See* Allocations of Value
- Signature
All Appraisers Who Sign Have Full
Responsibility, FAQ 235..... F-114
- And Letter of Transmittal, FAQ 234 F-113
- And Loss of Control, FAQ 239 F-115
- and Report, FAQ 233..... F-113
- Authorization of Use by Others, FAQ 237F-115
- Authorized Signature Permissible, FAQ 236F-114

Business Entity Can Sign Letter of Transmittal, FAQ 242..... F-116

Business Entity Cannot Sign Certification, FAQ 242 F-116

Defined, DEF U-4

Digital (Electronic) Reports, FAQ 241 .. F-116

Due Care Required, FAQ 238..... F-115

More than One Appraiser in an Assignment, AO-31 A-104

More Than One Appraiser May Sign, FAQ 235 F=114

Significant Appraisal Assistance
 Determining, FAQ 243 F-116

Software Responsibility
 AO-18 A-42
 SMT-2..... U-83

Soliciting..... *See Advertising*

Source, Non-source, Adjacent and Proximate Sites
 Defined, AO-9 A-19

Specifications *See Plans, Specification*

Standard (type) and Definition of Value
 Identify
 SR 9-2(c)..... U-71
 State Standard and Cite Source
 SR 10-2(a)(vi) U-76
 SR 10-2(b)(vi)..... U-78

Standard of Value*See Type and Definition of Value*

State
 in Reporting, AO-11 A-26

State Appraiser Boards
 and Confidentiality, FAQ 64 F-30

Subjective Phrases vs Factual Descriptions
 AO-16 A-35
 FAQ 15 F-7

Subsidized Housing
 Appraisals For, AO-14..... A-30

Sufficient Information*See Report, Sufficient Information*

Summarize in Reporting, AO-11 A-25

Summary Appraisal Report
 Content of, AO-11 A-23
 Required Content
 SR 2-2(b)..... U-25
 SR 8-2(b)..... U-65
 Use of, AO-12..... A-27

Supervising Appraiser
 Responsibility if Signing Report, FAQ 240F-116

Supervisor
 And Appraiser's Disagreement with Supervisor
 Opinion, FAQ 248..... F-120

Supervisory..... U-118

T

Technical Review
 Terminology,
 AO-20 A-55

Techniques..... *See Methods and Techniques*

Testimony
 and Record Keeping, FAQ 89..... F-41

Testimony and Written Appraisal Replot
 and Separate Signed Certification, FAQ 91F-42

Text Messages
 Considered to be Appraisal Reports, FAQ 264...
 F-129

Time period to retain workfile, FAQ 74 F-35

Transcript of Testimony
 and Workfile Requirement, FAQ 87..... F-41
 And Workfile Requirement, FAQ 88..... F-41

Transferring a Report..... *See Readdressing (Transferring) a Report*

Type and Definition of Value
 Client Provides, FAQ 159..... F-75
 Explained, FAQ 157 F-74

Identify
 SR 1-2(c)..... U-17
 SR 4-2(c)(ii) U-40
 SR 6-2(c)..... U-47
 SR 7-2(c)..... U-57

State and Cite Source
 SR 2-2(a)(v) U-23
 SR 2-2(b)(v) U-25
 SR 2-2(c)(v) U-27
 SR 6-8(h)..... U-53
 SR 8-2(a)(v) U-63
 SR 8-2(b)(v) U-65
 SR 8-2(c)(v) U-67

Value in Use, FAQ 167..... F-78

Type of Value .*See Type and Definition of Value*

U

Undisclosed Fees
 Payment to be on Approved List, FAQ 37F-17

Procurement of an Assignment
 Amount of Fee Paid, FAQ 44..... F-20
 Coupons for Discounts, FAQ 36 F-17
 Referral Fees, FAQ 35 F-17

Procurement of an Assignment ER..... U-8

Procurement of an Assignment, Things of Value
 FAQ 38..... F-18

Uniform Act
 and Before Value and JER, FAQ 207 F-98
 and Scope of Work, FAQ 183 F-84
 Review Appraiser Scope of Work, FAQ 313F-153

Uniform Relocation, FAQ 108 F-51

Uniform Relocation, FAQ 109 F-52

Unimpaired Value

Defined, AO-9	A-19
Unsupported Conclusions	
Fair Housing Laws, AO-16.....	A-34
Must Not Rely On, FAQ 15.....	F-7
Must not rely on, FAQ 33.....	F-15
Update of an Appraisal <i>Also See</i> Appraisal Update	
Different Scope of Work from First Appraisal,	
FAQ 194.....	F-91
First Assignment Performed by Another	
Appraiser, FAQ 196.....	F-91
New Assignment	
AO-3	A-8
FAQ 194.....	F-91
Reporting Requirements	
FAQ 263.....	F-129
FAQ 265.....	F-129
Requirements, AO-3.....	A-8
Update is a Business Term, FAQ 194.....	F-91
vs Recertification, FAQ 199.....	F-92
USPAP	
and Valuation for Financial Reporting, FAQ 7F-3	

V

Validated Offers	
Analyze, SR 7-5(a)	U-61
Valuation Methods	
and JER, FAQ 107.....	F-50
Valuation Services	
Defined	
FAQ 2.....	F-1
Defined, DEF.....	U-4
Outside of Appraisal Practice, AO-21	A-63
Relationship to Appraisal Practice, AO-21A-62	
Value	
Defined, DEF.....	U-5
Opinions Intentionally Deflated, FAQ 161F-76	
Opinions Intentionally Inflated, FAQ 161F-76	

W

Withdrawn Listings	
Obligation to Analyze, FAQ 151.....	F-72

Workfile.....	U-10
Workfile	
access and retrieval, FAQ 84	F-40
and Adequacy of Documentation, FAQ 94F-43	
and Oral Reports, FAQ 278	F-135
and Referencing Data Sources, FAQ 94 ..	F-43
Attorney Requests File, FAQ 80.....	F-38
Client Request to Purge, FAQ 78	F-37
Copies of Workfiles, AO-31	A-105
Copies of Workfiles, FAQ 79.....	F-37
Creating After Report Delivered, FAQ 86F-41	
Defined, DEF.....	U-5
Electronic Storage, FAQ 92.....	F-42
Enforcement Proceeding After USPAP Retention	
Requirements, FAQ 96.....	F-44
for Review Assignments, FAQ 77	F-36
is State Requirement Jurisdictional Exception,	
FAQ 95.....	F-44
Must Include, FAQ 73	F-35
paper copies, FAQ 93	F-43
Paper Copy of Report Delivered Electronically not	
Required, FAQ 283	F-138
Photocopy of Report in Workfile, FAQ 76F-36	
Retention When Buying Appraisal Practice,	
FAQ 72	F-34
Retention with More Than One Appraiser	
FAQ 79.....	F-37
Retention with More Than One Appraiser AO-31	
.....	A-105
Retention, Firm Employee, FAQ 80	F-38
Retention, Independent Contractor, FAQ 80F-38	
Signed Certification Required, FAQ 85... F-40	
State Requires Longer Retention Period, FAQ 95	
.....	F-44
Trainee Access, FAQ 81	F-39
True Copy of Report, FAQ 76	F-36
Workfile Access	
and Appraiser Not In Custody, FAQ 82 .. F-39	
Denied by Appraiser in Custody, FAQ 83F-40	
Workfile Retention	
and Appraiser Not In Custody, FAQ 82 .. F-39	
Written Report and Testimony	
and Transcript Requirement, FAQ 88.....	F-41

APPRAISAL STANDARDS BOARD



THE APPRAISAL FOUNDATION

*Authorized by Congress as the Source of Appraisal
Standards and Appraiser Qualifications*

THE MADISON BUILDING
1155 15TH STREET, NW, SUITE 1111
WASHINGTON, DC 20005

TEL 202 347 7722
FAX 202 347 7727

WWW.APPRAISALFOUNDATION.ORG

ISBN: 978-0-9798728-6-0



9 780979 872860